

Topological Manifolds

Contributors: Gopal Ananthakrishna, Anthony Conway, Ekin Ergen,
Raphael Floris, Daniel Galvin, Cara Hobohm, Robion Kirby, James Kister,
Danica Kosanović, Christian Kremer, Franca Lippert, Alice Merz,
Fadi Mezher, Weizhe Niu, Isacco Nonino, Mark Powell, Arunima Ray,
Benjamin Matthias Ruppik, Diego Santoro, and Magdalena von Wunsch.

Preface

These notes originated from a lecture course on topological manifolds held at the University of Bonn in the winter semester 2020-21. The lecturers were Mark Powell and Arunima Ray. The notes were typed up in a collaborative effort of the lecturers and many participants of the course, as listed. Almost all of the pictures were drawn by Danica Kosanović. Here is the course website: <https://maths.dur.ac.uk/users/mark.a.powell/topological-manifolds.html>.

There was a followup seminar course at the University of Bonn in the summer semester of 2021. Notes from those talks, provided by the speakers, have been incorporated into these notes. Here is the seminar website: <https://maths.dur.ac.uk/users/mark.a.powell/topological-manifolds-seminar.html>.

The lectures and seminar talks were live streamed, and recordings are available upon request. Please contact Mark or Aru for access.

Contents

Preface	i
List of Figures	vii
Preview	xiii
Part I. Basic notions	1
1. Definitions of topological manifolds <i>Robion Kirby, James Kister, Christian Kremer, Mark Powell, and Benjamin Matthias Ruppik</i>	3
2. Invariance of domain and applications <i>Christian Kremer, Mark Powell, and Benjamin Ruppik</i>	7
3. Embedding in Euclidean space <i>Raphael Floris, Robion Kirby, James Kister</i>	11
4. Collars and bicollars <i>Gopal Ananthakrishna and Mark Powell</i>	23
Part II. Topological embeddings	27
5. Wild embeddings <i>Danica Kosanović, Franca Lippert, and Arunima Ray</i>	29
6. The Schoenflies theorem <i>Danica Kosanović, Mark Powell, and Arunima Ray</i>	47
7. Spaces of embeddings and homeomorphisms <i>Mark Powell</i>	59
Part III. Microbundles	63
8. Microbundles and topological tangent bundles <i>Gopal Ananthakrishna, Danica Kosanović, Isacco Nonino, Mark Powell, and Benjamin Matthias Ruppik</i>	65
9. Normal microbundles and smoothing of a manifold crossed with Euclidean space <i>Mark Powell</i>	77
10. Homotopy invariance for microbundles <i>Cara Hobohm</i>	83
Part IV. h-cobordisms	91

11.	Smale's h -cobordism theorem <i>Arunima Ray</i>	93
12.	Finding a boundary for an open manifold <i>Alice Merz</i>	97
Part V. Piecewise-linear manifolds		111
13.	Piecewise linear manifolds <i>Arunima Ray</i>	113
14.	The Engulfing Theorem and uniqueness of PL structures on \mathbb{R}^n for $n \geq 5$ <i>Diego Santoro</i>	117
Part VI. The torus trick and the annulus theorem		131
15.	Homeomorphisms of \mathbb{R}^n and the torus trick <i>Anthony Conway, Danica Kosanović, and Arunima Ray</i>	133
16.	The torus trick in low dimensions <i>Daniel Galvin, Weizhe Niu, and Benjamin Matthias Ruppik</i>	145
17.	Stable homeomorphisms and the annulus theorem <i>Danica Kosanović, Mark Powell, and Arunima Ray</i>	173
18.	PL homotopy tori <i>Mark Powell</i>	189
19.	Local contractibility for manifolds and isotopy extension <i>Arunima Ray</i>	201
20.	Counting topological manifolds <i>Magdalena von Wunsch</i>	211
Part VII. Smoothing and PL-ing theory		221
21.	Classifying spaces <i>Mark Powell</i>	223
22.	Introduction to the product structure theorem, and smoothing and PL-ing theory <i>Danica Kosanović and Mark Powell</i>	229
23.	The homotopy groups of TOP / PL and TOP / O <i>Danica Kosanović and Mark Powell</i>	233
24.	Concordance implies isotopy <i>Mark Powell</i>	243
25.	The product structure theorem <i>Mark Powell</i>	249
26.	A non-PL-able manifold <i>Ekin Ergen</i>	255
Part VIII. Fundamental tools in topological manifolds		267

27. Handle decompositions and transversality <i>Danica Kosanović and Arunima Ray</i>	269
Part IX. Surgery theory	273
28. The surgery exact sequence <i>Mark Powell</i>	275
Part X. Double suspension theorem, triangulations, and homology manifolds	289
29. The double suspension of the Mazur homology sphere <i>Fadi Mezher</i>	291
Part XI. Solutions	303
30. Solutions to the exercises <i>Ekin Ergen, Christian Kremer, Isacco Nonino, and Arunima Ray</i>	305
Bibliography	319
Index	325

List of Figures

1.1	A regular topological space is the one in which for every point x and a closed set A there exist open sets U and V separating them.	4
4.1	The red region indicates the collar.	23
4.3	A local collar.	25
4.4	The local collars and pushing down into the exterior collar.	25
5.1	Examples of locally flat embeddings (in red).	29
5.2	Examples of non locally flat embeddings (in red) in D^2 .	30
5.3	Construction of Fox-Artin examples.	31
5.4	Fox-Artin arc α	31
5.5	Proof that the Fox-Artin arc is wild.	32
5.6	Proof that the Fox-Artin arc is wild.	32
5.7	The model half-ball for the arc β together with the open sets V_n (in blue) from the proof of Proposition 5.12.	33
5.8	Fox-Artin arc β .	33
5.9	Fox-Artin 1-sphere.	33
5.10	Fox-Artin 2-sphere.	34
5.11	The Alexander horned sphere	34
5.12	A pillbox. This picture is from [DV09a, p. 48].	35
5.13	The step B_0 to X_1 . Note that every space is solid here. The neighborhoods U_1 and U_2 are indicated in blue.	35
5.14	The Alexander horned sphere. Picture from [DV09a, p.50]	36
5.15	Another picture of the Alexander horned sphere. The length of the tubes needs to decrease to zero so that the limit points are reached. Picture from [BKK ⁺ 21, p.72]	37
5.16	Parts of this picture are from [DV09a].	38
5.17	A finite graph with $\pi_1(\mathbb{R}^3 \setminus G) \cong \pi_1(M_1)$. Picture from [Bin61].	39
5.18	A plug and an eyebolt.	40
5.19	The first stage H_1 of the construction of Bing's hooked rug. This picture is from [DV09a].	41
5.20	Parts of the manifold H_2 . The picture is from [DV09a].	41
5.21	The situation of Lemma 5.17. Picture from [DV09a, p.88]	43
5.22	The construction step $H_{i-1} \rightarrow H_i$ in more detail. Parts of the picture are from [DV09a]. Note that what is shown here is always just a part of H_i or H_{i-1} .	44
5.23	Arcs γ and δ respectively.	45

6.1	Idea of the proof of Schoenflies theorem: collapse the two components of the complement of a bicollar. Between the second and third pictures, the collar has been stretched out to cover most of the sphere, and the complementary regions have been shrunk to the two poles.	47
6.2	Some quotients of D^2 .	48
6.3	The building block for the Whitehead manifold.	48
6.4	Examples of cellular sets, with $\{B_i\}$ in orange.	49
6.5	Proof of Proposition 6.7: the map \mathfrak{s} shrinks the complement of the collar to the round ball.	51
6.6	Proof of Proposition 6.13	52
6.7	Proof of Proposition 6.15	53
6.8	The proof of the Schoenflies theorem in the smooth category for $n = 5$.	56
7.1	The unknot and the trefoil.	61
8.1	Tangent microbundle for $M = S^1$.	67
8.2	Nested balls in the stretching lemma, shown in g -coordinates.	69
8.3	The stretching function on the positive real line $[0, \infty)$.	69
8.4	The map σ applies the depicted map $\Theta_1(0, a, a'', b)$ in h -coordinates.	70
8.5		72
8.6	A parametrisation $\partial\sigma \times [0, 1]$ of the grey region $\sigma \setminus \sigma_1$ between the two simplices.	74
8.7	We define the bundle E_1 by gluing the two bundles over simplices σ and σ_1 , together with a transition in the region $\sigma \setminus \sigma_1$ given by Kister's isotopy.	74
10.1	Visualization of a bundle map germ	85
10.2	Visualization of the $U_{\alpha\beta}$	88
11.1	The Whitney move. Left: A Whitney disc D is shown in light green. Right: The Whitney move across D removes two intersection points.	95
12.1	The manifolds U_1, U_2 and V in Theorem 14.28.	98
12.2	The compact sets C_i and the compact manifolds U_i in the proof of Theorem 12.2.	99
12.3	The compact manifold V_i .	99
12.4	Ambient connected sum along the boundary.	100
12.5	The procedure described in the proof of Theorem 29.7: at first there is a curve γ which is non-trivial in $\pi_1(\partial U^3)$, in the second step we carved out a regular neighbourhood of $f(\Delta)$. At last, after applying repeatedly the described procedure, we obtain U with simply connected boundary.	102
12.6	Two discs D_{α_1} and D_{α_2} connected by a tube $D^k \times I$.	104
12.7	If the algebraic intersection of boundary of the disc D and the belt sphere of a k -handle is zero we can find a Whitney disc Δ .	105
12.8	The manifold X in W .	107
12.9	The manifold V .	110
13.1	The 2-dimensional 1-handle $B^1 \times B^1$ attaches along the yellow $S^0 \times B^1$, and the 3-dimensional 2-handle $B^2 \times B^1$ along the yellow $S^1 \times B^1$. Their cores are shown in red.	115

13.2	Construction of a handlebody decomposition from a triangulation. 0-handles are coloured orange, 1-handles are purple, and the 2-handle is yellow.	115
14.1		119
14.2	A sequence of elementary simplicial collapses.	119
14.3		119
14.4	A sequence of elementary collapses.	120
14.6		121
14.5		122
14.7		124
14.8		126
14.9		129
15.1	The key players in the proof of Theorem 15.4.	138
15.2	Recap of the proof of Theorem 15.4.	143
16.1	Two pictures of an immersion of a punctured 2-torus into the plane.	146
16.2	Embedding the 1-skeleton of the 3-torus into 3-space.	146
16.3	Thickened 2-torus with boundary of tubular neighborhood around longitude. This looks like the spin of the immersion in Figure 16.1.	147
16.4	Seeing part of the handle decomposition of the 3-torus in the overlaps of the immersion in Figure 16.3.	147
16.5	The circle S^1 satisfies Milnor's property \mathcal{J} .	148
16.6	Spinning the embedding $M^{k-1} \hookrightarrow \mathbb{R}^k$ (assuming it lies in the half-space $\{x_k > 0\}$) to obtain an embedding $M^{k-1} \times S^1 \hookrightarrow \mathbb{R}^{k+1}$.	149
16.7	Checking that the projection to a hyperplane is an immersion of a submanifold by looking at the normal vector.	149
16.8	Embedding a neighborhood $M^{k-1} \times (-\varepsilon, \varepsilon)$ into \mathbb{R}^k .	150
16.9	An example for the function $t: S^1 \rightarrow (-\varepsilon, \varepsilon)$. (© Milnor's letter in [KS77b])	150
16.10	Schematic of Milnor's perturbation of the spin. (© Milnor's letter in [KS77b])	150
16.11	The 1-skeleton of the 2-torus $\mathbb{T}_{(1)}^2$ and the 2-skeleton of the 3-torus $\mathbb{T}_{(2)}^3$.	153
16.12	Schematic of the projection of the perturbed torus in Ferry's proof	154
16.13	Setting up the notation for the subsets of the n -torus, where the circle factors are $S^1 = I \cup_{\partial} J$. Also pictures is an embedding $\mathbb{R}^n \times S^1 \hookrightarrow \mathbb{R}^{n+1}$, where the I -fibres $\{\text{pt.}\} \times I \subset \mathbb{R}^n \times I \subset \mathbb{R}^n \times S^1$ are straight and vertical in \mathbb{R}^{n+1} .	155
16.14	Base case: An immersion $f: \mathbb{T}^1 \times [-1, 1] \looparrowright \mathbb{R}^1 \times [-1, 1]$ such that the restriction to $\mathbb{T}_0^1 \times [-1, 1] = I \times [-1, 1]$ is a product map. (© [Rus73a])	155
16.15	Inductive step. (© [Rus73a])	156
16.16	The homeomorphism $\lambda: [-1, 1]^2 \rightarrow [-1, 1]^2$ which is the identity on the boundary $\partial([-1, 1]^2)$, and a $\frac{\pi}{2}$ -rotation on the smaller square $[-\frac{2}{3}, \frac{2}{3}]^2$. On the right is a picture of extending the map via the identity to a homeomorphism $\bar{\lambda}: S^1 \times [-1, 1] \rightarrow S^1 \times [-1, 1]$. (© [Rus73a])	156
16.17	Conjugation with λ applied to several squares. (© [Rus73a])	157
16.18	The global situation in the final construction. (© [Rus73a])	157

16.19	Smoothing a handle $B^k \times \mathbb{R}^n$ which is already smooth near $\partial B^k \times \mathbb{R}^n$, staying fixed in the red region.	158
16.20	Four iterations of steps 1-2 shown for an open set in \mathbb{R}^2 (shown in blue). The squares that have not been thrown away are shaded in red.	159
16.21	Pair of trousers (left) and twisted pair of trousers (right).	159
16.22	Twisted pair of trousers cut along a circle to give a Möbius band (green) and a normal pair of trousers (red).	160
16.23	Constructing a graph from a torus, cut along four circles into four pieces.	162
16.24	Torus trick diagram for the 0-handle case	163
16.25	The diffeomorphism $f: (B^1 \times \mathbb{R})_S \rightarrow B^1 \times \mathbb{R}$ fixing a neighbourhood of $\partial B^1 \times \mathbb{R}$ and sending flow lines of h to flow lines of π .	164
16.26	The diffeomorphism $g: B_S^2 \rightarrow B^2$ fixing a neighbourhood of ∂B^2 and sending flow lines for \tilde{r} to flow lines of r .	165
16.27	Two possible singularities	168
16.28	Torus trick diagram	170
17.1	The Annulus Theorem asserts that $D^n \setminus h(\text{Int } D^n)$, the closed grey region in the picture, is homeomorphic to an annulus.	173
17.2	Examples of annuli in \mathbb{R}^n (for $n = 2$).	174
17.3	The setup in the proof of $SH_n \implies AC_n$ from Theorem 17.9.	176
17.4	Arguments in the proof of $SH_n \implies AC_n$.	177
17.5	The proof of the stable homeomorphism theorem.	183
17.6	Step 2 of the proof: shrink $h_1\phi'(D^n)$ into $\text{Int } \phi(D^n)$.	185
17.7	The final homeomorphism K .	186
19.1		201
19.2	The setup of the Handle Straightening Lemma 19.7.	203
19.3	The torus trick for handle straightening.	204
19.4	Proof of Theorem 19.8	206
20.1	This figure shows the intuition behind the definition of $\varepsilon_{\alpha,j,m}$.	214
20.2	This is an example of a covering of a 1-manifold $M_\alpha \cong S^1$ with $k = 3$.	215
20.3	This is an example of a covering of a 2-manifold with boundary $M_\alpha \cong D^2$ with $k = 4$.	218
23.1		238
23.2	Modifying the PL homeomorphism f' by attaching into the collar of $\{0\} \times I^2 \times T^3$ an isotopy of g to the identity.	240
24.1	The given h is already a CAT embedding on the green region. After an isotopy we obtain h_1 which is also CAT near the blue region $I \times B^k \times B^n$.	243
24.2	An immersion of the n -torus.	244
24.3	Construction of Σ_2 .	246
24.4	The setup of the relative version of concordance implies isotopy.	248

25.1	Proof of the product structure theorem. Each square depicts $M = \mathbb{R}^m$ as the horizontal axis, with $U \subseteq M$ a subset of it, while the \mathbb{R} coordinate corresponds to the vertical axis. In each square, vertical lines indicate that the structure there is a product structure. Shaded yellow indicates that the structure coincides with Σ on that region. The top left square shows Σ , where we start. The top right shows Σ_1 . The bottom left square depicts Σ_2 . The bottom right shows the goal, $\sigma \times \mathbb{R}$, which agrees with Σ on $U \times \mathbb{R}$.	251
26.1	A visually inaccurate sketch of the construction of $(P_0 \times D^n)^\#$.	258
26.2	A visually even more inaccurate sketch of the construction of $M = (P_0 \times T^n)^\#$.	259
26.3	The torus-component of the covering space.	260
26.4	Schematic description of H'' .	264
27.1	The induction step in the proof of Theorem 27.4.	270
27.2	Reduction of the Poincaré conjecture to the h -cobordism theorem	271
29.1	Attaching of the 1-handle.	294
29.2	The Mazur link Γ_1 .	294
29.3	Cone containing a Fox-Artin arc.	296
29.4	Quotient space homeomorphic to the mapping torus Ω .	296
29.5	Transversal cut of $T(\sigma)$.	297
29.6	Visual representation of the above proof	299
29.7	Local neighborhoods homeomorphic to $\text{cone}(H^3) \times \mathbb{R}$	300
29.8	Sketch of the above collapse.	301
2.1	The two steps	306
8.8	The push-pull construction.	310
15.3	Schematic picture of the map h_i .	314
19.5	Moving points inside a disc	317
19.6	Another push-pull argument	317
19.7	Lining up ψ and ϕ	317

Preview

We begin with an overview of the field of topological manifold theory in general and a preview of what we will discuss. First, we define topological manifolds.

Definition 0.1 (Topological manifold). A topological space M is said to be an n -dimensional *topological manifold* if it is

- (i) Hausdorff, i.e. any two points may be separated by open neighbourhoods;
- (ii) locally Euclidean, i.e. for every $x \in M$ there is an open neighbourhood $U \ni x$ that is homeomorphic to either \mathbb{R}^n or $\mathbb{R}_+^n := \{\vec{y} \in \mathbb{R}^n \mid y_1 \geq 0\}$; and
- (iii) paracompact, i.e. any open cover has a locally finite refinement.

Note that by allowing the possibility of \mathbb{R}_+^n we are defining what some authors call a “manifold with boundary”. With our definition we avoid having to specify that a boundary is permitted, however this means we must then stipulate when one is expressly forbidden.

You may also have seen other definitions of manifolds, e.g. requiring second countability or metrisability. We will see presently that some other definitions are equivalent to the one above, and in the exercises you will explore examples of spaces lacking one or other of the above properties.

The word “manifold” comes from German. Specifically, Riemann used the term *Mannigfaltigkeit* in his PhD thesis to describe a certain generalisation of surfaces. This was translated to “manifoldness” by Clifford. Prior to Riemann, mathematicians had classically studied geometry, first Euclidean, then spherical and hyperbolic. Surfaces were studied in depth, including by Riemann. As you probably know the first systematic account of the field of topology was in *Analysis situs* by Poincaré, and the first definition he wrote down was of what he called a manifold. In modern terms, he defined a *smooth* manifold. Here is a quick reminder of the definition (the modern one, not Poincaré’s).

Definition 0.2 (Smooth manifold). Let M^n be a topological manifold. A *chart* on M is a pair (U, φ) where $U \subseteq M$ is open and $\varphi: U \xrightarrow{\cong} \mathbb{R}^n$ is a homeomorphism. If (U, φ) and (V, ψ) are two charts on M such that $U \cap V \neq \emptyset$ then the map $\psi \circ \varphi^{-1}$ is said to be a *transition map* (this is a homeomorphism, as a composite of homeomorphisms). If $\psi \circ \varphi^{-1}$ is further a diffeomorphism then the charts (U, φ) and (V, ψ) are said to be *smoothly compatible*.

A *smooth atlas* for M is a collection of smoothly compatible charts for M whose domains cover M . A *smooth structure* on M is a maximal smooth atlas, where *maximal* means that any chart smoothly compatible with the atlas is already contained in the atlas.

A couple of remarks are in order. First, Poincaré’s original definition of a (smooth) manifold had been as a subset of Euclidean space satisfying a given collection of smooth functions. The Whitney embedding theorem from the 1930s showed that every smooth n -manifold (satisfying the definition above) embeds in \mathbb{R}^{2n+1} , and so the two notions coincide.

Second, the definition above indicates a recipe for imposing more structure on topological manifolds. By requiring the transition maps to be smooth, we obtain smooth manifolds. Similarly, by imposing further (or fewer) conditions, e.g. symplectic, complex, C^1 , etc., we may produce more categories of manifolds. In this course, we will focus on unadulterated topological manifolds,

with occasional cameos by smooth manifolds and *piecewise-linear* manifolds. We define the latter next.

As you probably noticed in your algebraic topology courses, it is often convenient to work with simplicial complexes rather than purely abstract spaces, e.g. when computing homology groups. This was especially true in the early days of topology.

Definition 0.3. A manifold is said to be *triangulated* if it is homeomorphic to the geometric realisation of a (locally finite) simplicial complex.

A *piecewise-linear* manifold, often called a PL manifold is a manifold with a particularly nice triangulation.

Definition 0.4 (PL manifold (preliminary)). An n -manifold is *piecewise linear* (PL) if it has a triangulation such that the link of every vertex is a PL $(n - 1)$ -sphere or PL $(n - 1)$ -ball.

Rest assured, we will carefully define what a PL sphere is later in the course. An intuitive way to think about the definition is that it is a strengthening of the “locally Euclidean” condition in the definition of a manifold, specifically that not only does each point have a neighbourhood homeomorphic to Euclidean space, but that such neighbourhoods may further be taken to be PL equivalent to Euclidean space. An alternative definition of PL manifolds requires that the transition maps be piecewise-linear maps on Euclidean space (also to be defined carefully in the future). In other words, a PL manifold is a topological manifold with a maximal PL atlas. A result of Dedecker [Ded62] shows that the two definitions coincide.

By definition, both smooth and PL manifolds are topological manifolds, by forgetting the extra structure. By results of Cairns (1934) and Whitehead (1940) every smooth manifold is PL. Since the very inception of manifold theory, e.g. in *Analysis situs*, there has been much interest in the relationship between these three categories. Here are some other fundamental questions.

- (1) Is a given CW complex homotopy equivalent to a TOP manifold? PL? DIFF?
- (2) Given two manifolds, are they homotopy equivalent? Are they homeomorphic? If they are PL or smooth, are they PL homeomorphic or diffeomorphic respectively?
- (3) When do manifolds embed in one another?
- (4) For a given topological manifold M , what is the space of self-homeomorphisms $\text{Homeo}(M)$? Given a pair of manifolds M and N , what is the space of embeddings $\text{Emb}(M, N)$?

These are huge, very general questions. Too general, to expect to be able to have answers of a manageable level of complexity. We will make some initial steps on the long quest to answering interesting special cases of them in this course.

To guide our investigations, it might help to focus on some more specific questions, that we shall aim to discuss in the course, and which represent some highlights of the theory.

- The (generalised) **Poincaré conjecture**: if a closed n -dimensional manifold M is homotopy equivalent to the n -sphere S^n , is M homeomorphic to S^n ?
 - Yes, classical for $n \leq 2$, Perelman for $n = 3$ (2003), Freedman for $n = 4$ (1982), Smale, Stallings, Newman for $n \geq 4$ (1960s). True in PL category for $n \neq 5$, for $n = 4$ the PL question is equivalent to the DIFF question. In DIFF it has been reduced to problems in homotopy theory for $n > 4$, while it is wide open for $n = 4$.
- The **Schoenflies problem**: is every embedding of S^{n-1} in S^n equivalent to the standard (equatorial) embedding?
 - Solved in the topological category by M. Brown (1960), assuming bicollared, false otherwise. It is true in smooth category for $n \geq 5$, open for $n = 4$.
- Can topological manifolds be **triangulated**?
 - Not always, for $n = 4$ Casson (1980s), for $n \geq 5$ Manolescu (2013).
- **Double suspension problem**: Let M be a (homology) manifold with $H_*(M; \mathbb{Z}) \cong H_*(S^n; \mathbb{Z})$. Is the double suspension $\Sigma^2 M$ a TOP manifold? If yes, then $\Sigma^2 M \cong S^{n+2}$.

- Yes, Cannon, Edwards.

We will substantially address some of the above questions in this course. Some basic tools in smooth and PL topology include:

- tangent bundles;
- tubular neighbourhoods;
- handle decompositions; and
- transversality.

In stark contrast, these are difficult theorems in the topological category; we will see how to prove them.

Along with the tools listed above, there are also certain standard “tool theorems”, such as:

- the h - and s -cobordism theorems and
- the surgery exact sequence.

Indeed, one of the key consequences of transversality and the existence of handle decompositions in the topological category is making the s -cobordism theorem and surgery available.

An inane comment is that working purely in the topological category makes some things easier and some things harder. More specifically, major theorems like the Poincaré conjecture and the Schoenflies theorem are now known in the topological category, since it is comparatively easier to detect a topological ball or sphere, compared to a smooth one. The other side of the coin is that basic tools such as transversality and handlebody decompositions are harder to achieve in the topological category, since we do not impose so much structure to get these via the usual methods. Consequently, “standard” facts like the well-definedness of the connected sum operation become highly nontrivial to prove.

Along with the drastic contrast between categories, there is also a sharp distinction in the behaviour of low- and high-dimensional manifolds. A slogan here is that dimension 4 is a sort of phase transition. This is exemplified by the following facts:

- the topological manifold \mathbb{R}^n has a unique smooth structure if $n \neq 4$ and uncountably many smooth structures if $n = 4$; and
- a topological manifold M admits a topological handlebody decomposition precisely if M is not a non-smoothable 4-manifold.

0.1. Conventions

We will use the following notation for equivalence relations:

- \simeq for homotopy equivalences;
- \cong for homeomorphism;
- \cong_{C^∞} for diffeomorphisms.
- \cong_{PL} for PL homeomorphisms.

Part I

Basic notions

Definitions of topological manifolds

Robion Kirby, James Kister, Christian Kremer, Mark Powell, and Benjamin Matthias Ruppik

Let us discuss the definition of a topological manifold in more detail. We will present a series of alternative definitions. First we recall some terms.

Definition 1.1. A topological space X is *Hausdorff* if for every $x, y \in X$, with $x \neq y$, there exist disjoint open sets $U \ni x$ and $V \ni y$.

Definition 1.2. A subset $U \subseteq X$ of a topological space X is a *neighbourhood* of $x \in U$ if there is an open set $V \subseteq U$ with $x \in V$ and $\bar{V} \subseteq U$.

Definition 1.3. A collection of subsets $\{V_\alpha\}$ of X is *locally finite* if for every $x \in X$ there is a neighbourhood $U \ni x$ with $U \cap V_\alpha \neq \emptyset$ for finitely many α .

Definition 1.4. A topological space X is *paracompact* if every open cover $\{U_\alpha\}$ of X has a locally finite refinement. Here a refinement is another cover $\{V_\beta\}$ such that for each β , $V_\beta \subseteq U_\alpha$ for some α .

Now we recall the definition of a topological manifold from above.

Definition 1.5 (Topological manifold). A topological space M is an n -dimensional *topological manifold* (often from now on, a *manifold*) if it is

- (i) Hausdorff;
- (ii) locally n -Euclidean; and
- (iii) paracompact.

Here a space M is said to be *locally n -Euclidean* if for every $x \in M$ there is an open neighbourhood $U \ni x$ that is homeomorphic to either \mathbb{R}^n or

$$\mathbb{R}_+^n := \{\vec{y} \in \mathbb{R}^n \mid y_1 \geq 0\}.$$

We refer to such a U as a *coordinate neighbourhood*.

The *interior* $\text{Int } M$ of the manifold M is the union of all the points that have an open neighbourhood homeomorphic to \mathbb{R}^n . The *boundary* of M is defined as the complement of the interior

$$\partial M := M \setminus \text{Int } M.$$

A manifold is *closed* if it is compact and $\partial M = \emptyset$. A manifold is *open* if it is noncompact and $\partial M = \emptyset$.

Example 1.6. The line \mathbb{R} is a topological manifold. It is straightforward to see that \mathbb{R} is locally 1-Euclidean and Hausdorff. It is second countable because open intervals with rational centre and rational length form a countable basis for the topology. We will show below that connected, second countable, locally Euclidean, Hausdorff spaces are paracompact.

Example 1.7. The line with two origins, namely the quotient space of $\mathbb{R} \sqcup \mathbb{R}$ where x in the first \mathbb{R} is identified with x in the second \mathbb{R} for all $x \neq 0$, is locally Euclidean and paracompact, but is not Hausdorff.

Example 1.8. Let Ω be the first uncountable ordinal. Take one copy of $[0, 1)$ for each ordinal less than Ω . The *long line* is formed from stacking these half open intervals: define an order on the union of all $[0, 1)_\omega$, $\omega < \Omega$, as follows. If $x, y \in [0, 1)_\omega$ then define $x \leq y$ if and only if $x \leq y$. If $x \in [0, 1)_\omega$ and $y \in [0, 1)_{\omega'}$, with $\omega \neq \omega'$ then define $x < y$ if and only if $\omega < \omega'$.

THEOREM 1.9. *Let M be a Hausdorff, locally n -Euclidean topological space. Then the following are equivalent.*

- (i) M is paracompact;
- (ii) Every component M_α of M admits an exhaustion by compact sets. That is there is a countable sequence $\{C_i\}_{i=1}^\infty$ of compact sets C_i with $C_i \subseteq \text{Int } C_{i+1}$ and $\bigcup_{i=1}^\infty C_i = M_\alpha$.
- (iii) Every component of M is second countable.
- (iv) M is metrisable.

We remark that for many readers, an alternative and still satisfactory definition of a topological manifold would replace paracompact with second countable. We would then include the proviso that M has countably many connected components in (i) and (iv), remove ‘‘Every component of’’ from (iii), and remove ‘‘Every component M_α of’’ from (ii) i.e. take $M_\alpha = M$. It is perhaps a question of taste whether spaces with uncountably many connected components should be manifolds.

Proof. We will only give the argument for the case of empty boundary.

(iv) \Rightarrow (i) Here we quote a result that every metric space is paracompact [Mun00a, Theorem 41.4].

(iii) \Rightarrow (iv). We start by showing that every Hausdorff and locally Euclidean space M is regular.

To do this, first we claim that for every $x \in M$ and open $U \ni x$, there exists $W \ni x$ open with $x \in W \subseteq \overline{W} \subseteq U$. To prove the claim, let V be an open set containing x from the locally Euclidean hypothesis, and let $\varphi: V \rightarrow \mathbb{R}^n$ be a homeomorphism. Then $\varphi(U \cap V) \subseteq \mathbb{R}^n$ is open. It follows that there exists $\varepsilon > 0$ such that

$$Z := \overline{B_{\varepsilon/2}(\varphi(x))} \subseteq B_\varepsilon(\varphi(x)) \subseteq \varphi(U \cap V),$$

where $B_\delta(y)$ is the ball of radius δ and centre y . Now Z is closed and bounded and therefore is compact in \mathbb{R}^n by the Heine-Borel theorem. It follows that $\varphi^{-1}(Z)$ is compact, and then since M is Hausdorff, $\varphi^{-1}(Z)$ is closed. Now take W to be the point-set interior of Z , $\overset{\circ}{Z}$. Then $x \in W \subseteq \overline{W} \subseteq U \cap V \subseteq U$, as desired.

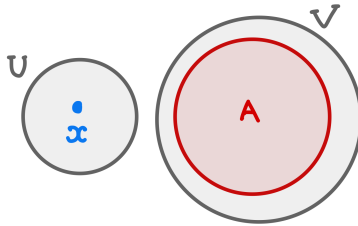

FIGURE 1.1. A regular topological space is the one in which for every point x and a closed set A there exist open sets U and V separating them.

Using the claim, we show that M is *regular*, meaning that for any closed set C and point x not in C , there exist open sets V, W with $x \in W$, $C \subseteq V$, and $V \cap W = \emptyset$. So fix C and x as above, and let $U := M \setminus C$, which is open. Then by the previous claim there exists an open set W with $x \in W \subseteq \overline{W} \subseteq U$. Define $V := M \setminus \overline{W}$, which contains C . Indeed $V \cap W = \emptyset$, so M is regular as asserted.

Now, the Urysohn metrisation theorem says that every Hausdorff, regular, second countable space is metrisable. This gives a metric on each connected component of M . Make each component diameter at most 1 by replacing the metric d with d' , where $d'(x, y) := \min\{d(x, y), 1\}$. Then set the distance between any two points in distinct connected components to be 2. This gives a metric on all of M , which completes the proof that ((iii)) \Rightarrow ((iv)).

((ii)) \Rightarrow ((iii)) Cover each C_i by finitely many coordinate neighbourhoods. It follows that each component of M has a countable cover by coordinate neighbourhoods. Each of these is open and second countable, so the entire component of M is also second countable.

((i)) \Rightarrow ((ii)) Let C denote a component of M . Since C is locally Euclidean, there exists an open cover $\{U_\alpha\}$ where each \bar{U}_α is compact. Let $\{V_\beta\}$ be a locally finite refinement. Then \bar{V}_β is a closed subset of a compact set so is compact.

We claim that each V_β intersects finitely many other sets $V_{\beta'}$, since V_β is compact. To see this, suppose it is false and choose $x_\alpha \in V_\alpha \cap V_\beta$ for infinitely many α . Since the V_β came from coordinate neighbourhoods, they are also sequentially compact (since \mathbb{R}^n is a metric space). Therefore the set $\{x_\alpha\}$ has a limit point y in \bar{V}_β . Any neighbourhood of y intersects infinitely many of the x_α , and therefore intersects infinitely many of the subsets V_α . This contradicts local finiteness, so completes the proof of the claim that V_β intersects finitely many other $V_{\beta'}$.

Now define Γ to be a graph with a vertex for each set V_β and an edge whenever $V_\beta \cap V_{\beta'} \neq \emptyset$. The graph Γ is connected since C is, and it is locally finite, meaning that each vertex is connected to finitely many edges.

We claim that a locally finite connected graph Γ is countable i.e. has countably many vertices. To see this, fix a vertex γ and let $\Gamma_n \subseteq \Gamma$ be the full subgraph consisting of all the vertices that can be reached from γ by a path intersecting at most n edges. Local finiteness implies that Γ_n is finite. Since Γ is locally connected it is path connected, and since a path intersects finitely many edges by compactness, every vertex is contained in Γ_n for some n . Therefore $\Gamma = \bigcup_{i=0}^{\infty} \Gamma_n$ is countable as claimed.

We deduce that $\{V_\beta\}$ is countable, so equals $\{V_1, V_2, \dots\}$ after relabelling. Define $C_1 := \bar{V}_1$. Note that C_1 is contained in a union of finitely many V_i . Call them V_{i_1}, \dots, V_{i_k} . Then define

$$C_2 := \bar{V}_2 \cup \bigcup_{j=1}^k \bar{V}_{i_j}.$$

Iterate this idea to define C_3, C_4 , and so on. This completes the proof of ((i)) \Rightarrow ((ii)). \square

EXERCISE 1.1. Give an example of a locally n -Euclidean, paracompact space that is not Hausdorff.

EXERCISE 1.2. Give an example of a locally n -Euclidean, Hausdorff space that is not paracompact.

EXERCISE 1.3. Every compact topological manifold embeds in \mathbb{R}^N for some N .

Invariance of domain and applications

Christian Kremer, Mark Powell, and Benjamin Ruppik

2.1. Invariance of domain

We study the invariance of domain theorem, following Casson's notes [Cas71]. This theorem has a simple and innocuous looking statement, but it is foundational to the theory of manifolds. The word domain is an old-fashioned word for an open set in \mathbb{R}^n , used frequently in complex analysis. The next theorem was one of the early triumphs of homology theory.

THEOREM 2.1 (Brouwer, 1910). *Let $U \subseteq \mathbb{R}^n$ be open and let $f: U \rightarrow \mathbb{R}^n$ be continuous and injective. Then $f(U) \subseteq \mathbb{R}^n$ is open and $f: U \rightarrow f(U)$ is a homeomorphism, i.e. f is an embedding.*

Definition 2.2. A map $f: X \rightarrow Y$ is called an *embedding* if f is injective and is a homeomorphism onto its image.

Note that in the smooth category, an embedding is also required to be an immersion, meaning that at each point the derivative is an injective linear map on tangent spaces. By the inverse function theorem this implies that an immersion is a local diffeomorphism. The condition for an embedding to be an immersion is equivalent to an embedding being a diffeomorphism onto its image.

COROLLARY 2.3. *Let $V \subseteq \mathbb{R}^n$ such that $V \cong U$ with $U \subseteq \mathbb{R}^n$ open. Then V is open in \mathbb{R}^n .*

Proof. Let $f: U \rightarrow V$ be the homeomorphism given in the statement. Apply invariance of domain to deduce that $f(U) = V$ is open. \square

An important consequence of invariance of domain is that the notion of dimension is well-defined for manifolds. Note that a topological manifold is locally path-connected, so it is connected if and only if it is path connected.

PROPOSITION 2.4. *There is a well-defined dimension for nonempty connected topological manifolds. That is, a nonempty Hausdorff, paracompact topological space that is locally n -Euclidean cannot be locally m -Euclidean for $m \neq n$.*

As a consequence, we will drop the n prefix from n -Euclidean from now on.

Proof. We will only argue for the case of empty boundary. Let M be an n -dimensional manifold and let A and B neighbourhoods of a point p in M together with homeomorphisms $\varphi: A \xrightarrow{\cong} \mathbb{R}^n$ and $\psi: B \xrightarrow{\cong} \mathbb{R}^m$. Suppose without loss of generality that $m < n$. Then we have a homeomorphism

$$\psi \circ \varphi^{-1}: U := \varphi(A \cap B) \rightarrow V := \psi(A \cap B) \subseteq \mathbb{R}^m \subseteq \mathbb{R}^n.$$

Here we include $\mathbb{R}^m \subseteq \mathbb{R}^n$ using the standard inclusion. Then $U \subseteq \mathbb{R}^n$ is open and $U \cong V$. So by Corollary 2.3 we see that V is open in \mathbb{R}^n . But any open ball around a point in V is not contained in \mathbb{R}^m , so is certainly not contained in V . It follows that V cannot be open in \mathbb{R}^n . This contradiction implies that the initial set up cannot exist, which proves the proposition. \square

COROLLARY 2.5. *Let M be an n -manifold. Then $\partial M = M \setminus \text{Int } M$ is an $(n - 1)$ -manifold without boundary.*

Proof. Let $x \in M$ and let $f: \mathbb{R}_+^n \rightarrow M$ be a map that is a homeomorphism onto its image, which is an open neighbourhood of x .

CLAIM. *We have that $x \in \partial M$ if and only if $x \in f(\mathbb{R}^{n-1})$, where we consider $\mathbb{R}^{n-1} \subseteq \mathbb{R}^n$ via $\vec{x} \mapsto (0, \vec{x})$.*

Note that the claim in particular says that the boundary can potentially be nonempty. It could have been, a priori, that every point with an \mathbb{R}_+^n neighbourhood also secretly lives in the interior by virtue of a different \mathbb{R}^n neighbourhood. This is not the case.

Let us prove the claim. We will prove the contrapositive of each inclusion. So suppose that $x \notin f(\mathbb{R}^{n-1})$. Then $x \in f(\mathbb{R}_+^n \setminus \mathbb{R}^{n-1}) \cong \mathbb{R}^n$, so $x \in \text{Int } M$. Therefore $x \notin \partial M$.

Now suppose that $x \notin \partial M$. Then $x \in \text{Int } M$. So there exists $U \ni x$ open in M with $U \cong \mathbb{R}^n$. Therefore there is a neighbourhood V of x with $V \subseteq U$ and $V \subseteq f(\mathbb{R}^{n-1}) \subseteq M$, with V homeomorphic to an open subset of \mathbb{R}^n . Therefore

$$f^{-1}(V) \subseteq \mathbb{R}_+^n \subseteq \mathbb{R}^n.$$

By invariance of domain, $f^{-1}(V)$ is open in \mathbb{R}^n .

Now suppose for a contradiction that $x \in f(\mathbb{R}^{n-1})$ then $f^{-1}(x) \in \mathbb{R}^{n-1}$. But $f^{-1}(V)$ cannot simultaneously be open in \mathbb{R}^n and be an open neighbourhood of $f^{-1}(x) \in \mathbb{R}^{n-1}$. Therefore $x \notin f(\mathbb{R}^{n-1})$. This completes the proof of the claim that $x \in \partial M$ if and only if $x \in f(\mathbb{R}^{n-1})$.

Now we prove the corollary. Let $y \in \partial M$. Let $g: \mathbb{R}_+^n \xrightarrow{\cong} M$ be a coordinate neighbourhood. Then $g(\mathbb{R}_+^n) \cap \partial M = g(\mathbb{R}_+^n) \cap g(\mathbb{R}^{n-1}) = g(\mathbb{R}^{n-1})$ is an open set in ∂M homeomorphic to \mathbb{R}^{n-1} , so ∂M is locally $(n - 1)$ -Euclidean, as required. Note that ∂M is certainly Hausdorff and paracompact. \square

COROLLARY 2.6. *Let M^m, N^n be manifolds. Then $M \times N$ is an $(m + n)$ -manifold with*

$$\partial(M \times N) = M \times \partial N \cup_{\partial M \times \partial N} \partial M \times N$$

Proof. Each point in $M \times N$ has an open neighbourhood homeomorphic to one of $\mathbb{R}^m \times \mathbb{R}^m$, $\mathbb{R}^m \times \mathbb{R}_+^n$, $\mathbb{R}_+^m \times \mathbb{R}_+^n$, or $\mathbb{R}^m \times \mathbb{R}_+^n$. Apart from the first one, the other three are all homeomorphic to \mathbb{R}_+^{m+n} . As we showed in the proof of the previous corollary, the boundary $\partial(M \times N)$ is precisely the points which have one of the neighbourhoods of the latter three types. \square

The boundary of a smooth product has corners, but we do not have to worry about corner points in the topological category. A helpful example to consider is that the disc and the square are homeomorphic. What is the smooth structure on a square? Is it equivalent to the smooth structure on a disc?

Having explained some important consequences of invariance of domain, now we begin to prove it. We will need the following two manifolds:

$$S^n = \{\vec{x} \in \mathbb{R}^{n+1} \mid \|\vec{x}\| = 1\}$$

$$D^n = \{\vec{x} \in \mathbb{R}^{n+1} \mid \|\vec{x}\| \leq 1\}.$$

LEMMA 2.7. *Let $X \subseteq S^n$ be a subset of the n -sphere which is homeomorphic to a disc, $X \cong D^k$. Then for all degrees $r \in \mathbb{N}_0$, the reduced homology groups of the complement vanish, $\tilde{H}_r(S^n \setminus X) = 0$.*

Proof. The proof is by induction on k . For $k = 0$, $S^n \setminus \{\text{pt}\} \cong \mathbb{R}^n$ so is contractible.

Now assume that the lemma holds for k . Choose a homeomorphism

$$f: D^k \times I \cong D^{k+1} \cong X$$

Let $t \in I = [0, 1]$. Note that for every $t \in I$ we have

$$\tilde{H}_*(S^n \setminus f(D^k \times \{t\})) = 0$$

by the inductive hypothesis. Let $[\alpha] \in \tilde{H}_r(S^n \setminus X)$ be a class in reduced homology for some $r \geq 0$; we want to show that α is the trivial class. We can write $\alpha = \partial c_t$ for some chain c_t in $C_{r+1}(S^n \setminus D^k \times \{t\})$. Since c_t is a sum of finitely many singular simplices, its image is compact. Therefore there exists an open interval J_t of t in I such that c_t lies in $S^n \setminus f(D^k \times J_t)$. Since I is compact, we can find a finite partition

$$0 = t_0 < t_1 < t_2 < \cdots < t_\ell = 1$$

such that $[t_i, t_{i+1}] \subseteq J_\tau$ for some $\tau \in J_\tau$. For $0 \leq p \leq q \leq \ell$, we consider the inclusion induced homomorphisms

$$\phi_{p,q}: \tilde{H}_r(S^n \setminus X) \rightarrow \tilde{H}_r(S^n \setminus f(D^k \times [t_p, t_q])).$$

We know that $\phi_{p-1,p}(\alpha) = 0$ for every p because α bounds c_τ in $C_{r+1}(S^n \setminus f(D^k \times [t_{p-1}, t_p]))$ for some $\tau \in I$.

We want to show that $\phi_{0,\ell}(\alpha) = 0$. Then since $\phi_{0,\ell} = \text{Id}: \tilde{H}_r(S^n \setminus X) \rightarrow \tilde{H}_r(S^n \setminus X)$, it will follow that $\alpha = 0$ as desired. We show by induction that $\phi_{0,i}(\alpha) = 0$. For $i = 1$, this holds as the case $p = 1$ of $\phi_{p-1,p}(\alpha) = 0$.

The sets $S^n \setminus f(D^k \times [t_p, t_{p+1}])$ are open. We apply Mayer-Vietoris for

$$S^n \setminus f(D^k \times \{t_i\}) = S^n \setminus f(D^k \times [0, t_i]) \cup_{S^n \setminus f(D^k \times [0, t_{i+1}])} S^n \setminus f(D^k \times [t_i, t_{i+1}]).$$

Since we know that $\tilde{H}_s(S^n \setminus f(D^k \times \{t_i\})) = 0$, we obtain a commutative diagram

$$\begin{array}{ccccccc} 0 & \longrightarrow & \tilde{H}_r(S^n \setminus f(D^k \times [0, t_{i+1}])) & \xrightarrow{\cong} & \tilde{H}_r(S^n \setminus f(D^k \times [0, t_i])) \oplus \tilde{H}_r(S^n \setminus f(D^k \times [t_i, t_{i+1}])) & \longrightarrow & 0 \\ & & \uparrow \phi_{0,i+1} & \nearrow \phi_{0,i} \oplus \phi_{i,i+1} & & & \\ & & \tilde{H}_r(S^n \setminus X) & & & & \end{array}$$

The diagonal map sends α to 0, so we deduce that $\phi_{0,i+1}(\alpha) = 0$. Then by induction $\phi_{0,\ell}(\alpha) = 0$, so $\alpha = 0$ as desired. \square

LEMMA 2.8. *If $X \subseteq S^n$ is homeomorphic to S^k , then*

$$\tilde{H}_r(S^n \setminus X) \cong \tilde{H}_r(S^{n-k-1}) \cong \begin{cases} \mathbb{Z} & r = n - k - 1 \\ 0 & \text{else.} \end{cases}$$

Proof. The proof is by induction on k . For $k = 0$, for any two points p, q in S^n , we have that $S^n \setminus \{p, q\}$ is homeomorphic to $\mathbb{R}^n \setminus \{0\}$, which is homotopy equivalent to S^{n-1} . Now assume the lemma holds for $k - 1$. Let $f: S^k \xrightarrow{\cong} X$ be a homeomorphism. Let D_+ and D_- be hemispheres of S^k , with $S^k = D_+ \cup D_-$ and $D_+ \cap D_- \cong S^{k-1}$. Write $X_\pm := f(D_\pm)$ and $X_e = X_+ \cap X_-$. Then note that $S^n \setminus X = (S^n \setminus X_+) \cap (S^n \setminus X_-)$. Furthermore $S^n \setminus X_+ \cup S^n \setminus X_- = S^n \setminus X_e$. In addition $S^n \setminus X_\pm$ and $S^n \setminus X_e$ are open. Now Lemma 2.7 yields $\tilde{H}_r(S^n \setminus X_\pm)$ so that the Mayer-Vietoris sequence yields:

$$0 \rightarrow \tilde{H}_{r+1}(S^n \setminus X_e) \xrightarrow{\cong} \tilde{H}_r(S^n \setminus X) \rightarrow 0.$$

By the inductive hypothesis

$$\tilde{H}_{r+1}(S^n \setminus X_e) \cong \begin{cases} \mathbb{Z} & r + 1 = n - (k - 1) - 1 \\ 0 & \text{else} \end{cases} \cong \begin{cases} \mathbb{Z} & r = n - k - 1 \\ 0 & \text{else.} \end{cases} \quad \square$$

COROLLARY 2.9 (Jordan-Brouwer separation). *Let $f: S^{n-1} \rightarrow S^n$ be an injective, continuous map. Then f is an embedding and $S^n \setminus f(S^{n-1})$ has two connected components, both of which are open in S^n .*

We will use the following closed map lemma, also sometimes known as the compact-Hausdorff lemma.

LEMMA 2.10. *Let $f: X \rightarrow Y$ be a continuous injective map from a compact space X to a Hausdorff space Y . Then f is a homeomorphism onto its image and a closed map.*

Proof. Let U be a closed set in X . Then U is compact since X is compact. Therefore $f(U)$ is compact. So $f(U)$ is closed because Y is Hausdorff. It follows that $f^{-1}: f(X) \rightarrow X$ is continuous, so that $f: X \rightarrow f(X)$ is a homeomorphism. \square

Proof of Corollary 2.9. By the closed map lemma $f: S^{n-1} \rightarrow S^n$ is an embedding and has closed image, so in particular $S^n \setminus f(S^{n-1})$ is open. Since $S^n \setminus f(S^{n-1})$ is locally path-connected, and since S^n is a manifold, the number of components equals the number of path components. By Lemma 2.8, $\tilde{H}_0(S^n \setminus f(S^{n-1})) \cong \mathbb{Z}$, which shows that there are two path components. Components are always closed, and since there are finitely many components, both are open as well. They are open in $S^n \setminus f(S^{n-1})$, and therefore they are also open in S^n since $S^n \setminus f(S^{n-1})$ is open. \square

COROLLARY 2.11. *Let $f: D^n \rightarrow S^n$ be injective and continuous. Then $f(\text{Int } D^n)$ is open in S^n .*

Proof. By Lemma 2.7, $\tilde{H}_0(S^n \setminus f(D^n)) = 0$, so $S^n \setminus f(D^n)$ is connected. Now

$$S^n \setminus f(S^{n-1}) = f(\text{Int } D^n) \cup S^n \setminus f(D^n).$$

The left hand space is not connected by Corollary 2.9: it has exactly two connected components. The two spaces on the right hand side are connected.

We deduce that $f(\text{Int } D^n)$ is precisely one of the two open components in $S^n \setminus f(S^{n-1})$, so is open by Corollary 2.9. \square

Now we have finally assembled the ingredients necessary to prove invariance of domain.

Proof of Invariance of Domain Theorem 2.1. Postcompose $f: U \rightarrow \mathbb{R}^n$ with the inclusion into S^n . For a point $x \in U$, there exists a small closed metric ball B still contained in U . The map $f|_B: B \rightarrow S^n$ fulfills the conditions of Corollary 2.11 so that $f(\text{Int } B)$ is open in S^n , hence an open neighbourhood of $f(x)$. We have shown that every point in the image of f has a neighbourhood inside the image of f , hence f has open image. Furthermore, since interiors of closed balls constitute a basis for the topology of U , this argument also shows that f is an open map. \square

EXERCISE 2.1. (PS6.1) Every connected topological manifold with empty boundary is *homogeneous*. That is, for any two points $a, b \in M$, there exists a homeomorphism $h: M \rightarrow M$ with $h(a) = b$.

Hint: show that for any two points a, b in $\text{Int } D^n$, there is a homeomorphism of D^n mapping a to b and fixed on the boundary. Next show that the orbit of any given point in M under the action of $\text{Homeo}(M)$ is both open and closed in M .

CHAPTER 3

Embedding in Euclidean space

Raphael Floris, Robion Kirby, James Kister

Here are some further properties of topological manifolds..

THEOREM 3.1. *Every m -dimensional topological manifold has covering dimension m .*

That is, every open cover has an order m refinement, so there are at most $m + 1$ sets in the refinement in any nonempty intersection. That is, $\bigcap_{i=1}^k V_{\beta_i} \neq \emptyset$ implies that $k \leq m + 1$.

THEOREM 3.2. *Every component of an m -dimensional topological manifold embeds in \mathbb{R}^N for some N . In fact $N = 2m + 1$ suffices.*

THEOREM 3.3. *Every topological manifold is an ANR and an ENR.*

These notions will be defined below.

THEOREM 3.4. *Every topological manifold admits a partition of unity.*

That is, there exist functions $\{\phi_\alpha: X \rightarrow I\}$ such that (i) $\{\phi_\alpha^{-1}((0, 1])\}$ is locally finite, and (ii) $\sum_\alpha \phi_\alpha(x) = 1$ for all $x \in X$.

THEOREM 3.5. *Every topological manifold is homotopy equivalent to a cell complex.*

3.1. Embedding smooth manifolds

For smooth manifolds the following well-known result holds.

THEOREM 3.6 (Whitney Embedding Theorem). *Every smooth n -manifold M admits a closed smooth embedding $\iota: M \hookrightarrow \mathbb{R}^{2n+1}$.*

Furthermore, it can be shown that every embedded smooth manifold $M \subseteq \mathbb{R}^N$ has a *tubular neighbourhood*.

THEOREM 3.7 (Tubular neighbourhood Theorem). *Let $M \subseteq \mathbb{R}^N$ be an embedded smooth manifold. Then M possesses a tubular neighbourhood, i.e. there exists an open neighbourhood $U \subseteq \mathbb{R}^N$ of M that is diffeomorphic to a set $V \subseteq NM$ of the type*

$$V = \{(x, v) \in NM \mid |v| < \delta(x)\},$$

where $\delta: M \rightarrow (0, \infty)$ is continuous and NM denotes the normal bundle of M , via the map

$$\theta: NM \rightarrow \mathbb{R}^N, (x, v) \mapsto x + v.$$

Let us recall the definition of ENRs.

Definition 3.8. A topological space X is a *Euclidean Neighbourhood Retract (ENR)* if there exists a closed embedding $\iota: X \hookrightarrow \mathbb{R}^N$ for some $N \in \mathbb{N}$ and an open neighbourhood $U \subseteq \mathbb{R}^N$ of $\iota(X)$ such that U is a retraction of U , i.e. there exists a continuous map $r: U \rightarrow \iota(X)$ satisfying $r|_{\iota(X)} = \text{id}_{\iota(X)}$.

It can be shown that any embedded smooth manifold $M \subseteq \mathbb{R}^N$ is a retract of every tubular neighbourhood of M , hence we have the following.

COROLLARY 3.9. *Every smooth manifold is an ENR.*

A detailed account is given in [Lee13a, Chapter 6].

In this talk, we want to prove the following corresponding results for topological manifolds.

THEOREM 3.10. *Let X be a second-countable locally compact Hausdorff space such that every compact subspace of X has dimension at most $n \in \mathbb{N}$. Then X admits a closed embedding $\iota: X \hookrightarrow \mathbb{R}^{2n+1}$.*

THEOREM 3.11. *Every topological manifold is an ENR.*

This is essentially due to Hanner [Han51a]. We mainly follow indications by Munkres [Mun00b] and unpublished notes by Kirby and Kister [KK] adding many details.

Remark 3.12. Throughout these notes, we denote by $\mathbb{N} := \{1, 2, \dots\}$ the set of positive integers and by $\mathbb{N}_0 := \{0, 1, 2, \dots\}$ the set of non-negative integers.

3.2. Dimension Theory

Definition 3.13. Let X be a topological space and let \mathcal{U} be an open covering of X . A *refinement* of \mathcal{U} is an open cover \mathcal{V} of X such that every $V \in \mathcal{V}$ is contained in some $U \in \mathcal{U}$, i.e. $V \subseteq U$.

Definition 3.14. Let X be a topological space.

- (1) A collection \mathcal{A} of subsets of X has *order* $m \in \mathbb{N}_0$ if m is the largest integer such that there are $m + 1$ elements of \mathcal{A} having a non-empty intersection.
- (2) X is called *finite-dimensional* if there exists some $m \in \mathbb{N}_0$ such that every open cover of X possesses a refinement of order at most m .

The smallest such m is called the (*topological*) *dimension* of X , denoted by $\dim X$.

If X is a topological space and \mathcal{A} is a collection of subsets of X , then \mathcal{A} has order m if and only if there exists some $x \in X$ that lies in $m + 1$ elements of \mathcal{A} and no point of X lies in more than $m + 1$ elements of \mathcal{A} .

Let us illuminate the notion of topological dimension with an example.

Example 3.15. Let $I := [0, 1]$ denote the closed unit interval. We want to show that $\dim I = 1$. Let \mathcal{U} be an open cover of I . Since I is a compact metric space, \mathcal{U} has a positive Lebesgue number $\lambda > 0$, i.e. every subset of I having diameter less than λ is contained in an element of \mathcal{U} . For $k \in \mathbb{N}_0$, let $J_k := \left((k-1) \cdot \frac{\lambda}{4}, (k+1) \cdot \frac{\lambda}{4} \right)$. Since $\text{diam } J_k = \frac{\lambda}{2} < \lambda$, we can conclude that $\mathcal{V} := \{J_k \cap I\}_{k \in \mathbb{N}_0}$ is a refinement of \mathcal{U} . Since \mathcal{V} has order 1, this shows $\dim I \leq 1$.

In order to show that $\dim I \geq 1$, we consider the open cover $\mathcal{U} := \{[0, 1), (0, 1]\}$. If $\dim I = 0$, \mathcal{U} would have a refinement \mathcal{V} of order 0. Since \mathcal{V} refines \mathcal{U} , we get $\text{card}(\mathcal{V}) \geq 2$ (note that $0 \in V_1$ and $1 \in V_2$ for some $V_1, V_2 \in \mathcal{V}$ and because \mathcal{V} refines \mathcal{U} , we get $V_1 \subseteq [0, 1)$ and $V_2 \subseteq (0, 1]$ and thus $V_1 \neq V_2$). Let V be any element of \mathcal{V} and let W be the union of all $V' \in \mathcal{V} \setminus V$. Then both V and W are open and $V \cup W = I$ and $V \cap W = \emptyset$, because \mathcal{V} has order 0, which is a contradiction since I is connected.

Thus, $\dim I \geq 1$ and therefore $\dim I = 1$.

We can use Lebesgue numbers to show a more general result that will be needed throughout this section.

THEOREM 3.16. *Let $n \in \mathbb{N}$. Every compact subspace of \mathbb{R}^n has topological dimension at most n .*

Proof. Let us first divide \mathbb{R}^n into unit cubes. Let

$$\mathcal{G} := \{(k, k+1)\}_{k \in \mathbb{Z}}$$

$$\mathcal{K} := \{\{k\}\}_{k \in \mathbb{Z}}.$$

If $0 \leq d \leq n$, we define \mathcal{C}_d to be the set of all products

$$A_1 \times \cdots \times A_n \subseteq \mathbb{R}^n,$$

where precisely d of the sets A_1, \dots, A_n are an element of \mathcal{G} and the remaining $n-d$ ones are an element of \mathcal{K} .

Set $\mathcal{C} := \mathcal{C}_0 \cup \cdots \cup \mathcal{C}_n$. Then for every $x \in \mathbb{R}^n$ there exists a unique $C \in \mathcal{C}$ such that $x \in C$.

CLAIM. *Let $0 \leq d \leq n$. For every $C \in \mathcal{C}_d$, there exists an open neighbourhood $U(C)$ of C satisfying:*

- (1) $\text{diam } U(C) \leq \frac{3}{2}$
- (2) $U(C) \cap U(D) = \emptyset$ whenever $D \in \mathcal{C}_d \setminus \{C\}$.

Proof of claim. Let $x = (x_1, \dots, x_n) \in C$. We will show that there exists a number $0 < \varepsilon(x) \leq \frac{1}{2}$ such that the open cube centered at x with radius $\varepsilon(x)$, i.e. the set

$$W_{\varepsilon(x)}(x) = (x_1 - \varepsilon(x), x_1 + \varepsilon(x)) \times \cdots \times (x_n - \varepsilon(x), x_n + \varepsilon(x)),$$

intersects no other element of \mathcal{C}_d . If $d = 0$, choose $\varepsilon(x) := \frac{1}{2}$. If $d > 0$, exactly d of the numbers x_1, \dots, x_n are not integers. Choose $0 < \varepsilon(x) \leq \frac{1}{2}$ such that for each $1 \leq i \leq n$ that satisfies $x_i \notin \mathbb{Z}$, the interval $(x_i - \varepsilon(x), x_i + \varepsilon(x))$ contains no integer. If $y = (y_1, \dots, y_n) \in W_{\varepsilon(x)}(x)$, we have $y_i \notin \mathbb{Z}$ whenever $x_i \notin \mathbb{Z}$. Thus, either $y \in C$ or $y \in C'$ for some $C' \in \mathcal{C}_{d'}$ where $d' > d$. In conclusion, $W_{\varepsilon(x)}(x)$ intersects no other element of \mathcal{C}_d .

Now let $U(C)$ be the union of all $W_{\frac{\varepsilon(x)}{2}}$ where $x \in C$. Then obviously $U(C) \cap U(D) = \emptyset$ whenever $D \in \mathcal{C}_d \setminus \{C\}$. This proves (2).

If $x, y \in U(C)$, we have $x \in W_{\frac{\varepsilon(x)}{2}}(x')$ and $y \in W_{\frac{\varepsilon(y')}{2}}(y')$ for some $x', y' \in C$. By the triangle inequality

$$\|x - y\|_\infty \leq \|x - x'\|_\infty + \|x' - y'\|_\infty + \|y' - y\|_\infty \leq \frac{1}{4} + 1 + \frac{1}{4} = \frac{3}{2},$$

hence establishing (1). □

Now let $\mathcal{A} := \{U(C) \mid C \in \mathcal{C}\}$. Then \mathcal{A} is an open cover of \mathbb{R}^n of order n by (2). Let $K \subseteq \mathbb{R}^n$ be compact and let \mathcal{U} be an open cover of K . Since K is compact metric, \mathcal{U} has a positive Lebesgue number $\lambda > 0$.

Consider the homeomorphism $f: \mathbb{R}^n \rightarrow \mathbb{R}^n$, $x \mapsto \frac{\lambda}{3} \cdot x$. Since \mathcal{A} is an open cover of order n , so is $\mathcal{A}' := \{f(U(C)) \mid C \in \mathcal{C}\}$. Since $\text{diam } f(U(C)) \leq \frac{\lambda}{2} < \lambda$ for all $C \in \mathcal{C}$, we get that $\{f(U(C)) \cap K\}_{C \in \mathcal{C}}$ is an open cover of K that refines \mathcal{U} and has order at most n .

Thus, $\dim K \leq n$, as desired. □

We need some more elementary properties of the topological dimension before we can proceed to manifolds.

LEMMA 3.17. *Let X be a finite-dimensional topological space and let Y be a closed subspace of X . Then Y is also finite-dimensional and $\dim Y \leq \dim X$.*

Proof. Let $d := \dim X$. Let \mathcal{U} be an open cover of Y . For every $U \in \mathcal{U}$ there exists some open $U' \subseteq X$ such that $U = U' \cap Y$. Let $\mathcal{A} := \{U'\}_{U \in \mathcal{U}} \cup \{X \setminus Y\}$. Then \mathcal{A} is an open cover of X and thus possesses a refinement \mathcal{B} of order at most d . Therefore, $\mathcal{V} := \{B \cap Y\}_{B \in \mathcal{B}}$ is an open cover of Y of order at most d that refines \mathcal{U} . This proves $\dim Y \leq d$. □

THEOREM 3.18. *Let X be a topological space and assume $X = X_1 \cup X_2$ for some closed finite-dimensional subspaces $X_1, X_2 \subseteq X$. Then X is also finite-dimensional and*

$$\dim X = \max\{\dim X_1, \dim X_2\}.$$

Let us fix a notion for the proof of this theorem. If \mathcal{U} is an open cover of X and $Y \subseteq X$ is a subspace of X , we say that \mathcal{U} has *order $m \in \mathbb{N}_0$ in Y* if there exists some point $y \in Y$ that is contained in $m + 1$ distinct elements of \mathcal{U} and no point of Y is contained in more than $m + 1$ distinct elements of \mathcal{U} .

Proof. By Lemma 1.5, it suffices to prove $\dim X \leq \max\{\dim X_1, \dim X_2\}$.

CLAIM. *Let \mathcal{U} be an open cover of X and let Y be a closed subspace of X such that $\dim Y \leq d < \infty$. Then \mathcal{U} possesses a refinement that has order at most d in Y .*

Proof of claim. Let $\mathcal{A} := \{U \cap Y\}_{U \in \mathcal{U}}$. Since \mathcal{A} is an open cover of Y and $\dim Y \leq d$, there exists a refinement \mathcal{B} of \mathcal{A} of order at most d . For every $B \in \mathcal{B}$, there exists some open set $U_B \subseteq X$ such that $B = U_B \cap Y$. Furthermore, there exists some $A_B \in \mathcal{U}$ such that $B \subseteq A_B \cap Y$. Then, $\{U_B \cap A_B\}_{B \in \mathcal{B}} \cup \{U \setminus Y\}_{U \in \mathcal{U}}$ is an open cover of X that refines \mathcal{U} and has order at most d in Y . \square

Now, let $d := \max\{\dim X_1, \dim X_2\}$ and let \mathcal{U} be an open cover of X . We need to show that \mathcal{U} has a refinement \mathcal{V} of order at most d .

Let \mathcal{A}_1 be a refinement of \mathcal{U} of order at most d in X_1 and let \mathcal{A}_2 be a refinement of \mathcal{A}_1 of order at most d in X_2 . We can define a map $f: \mathcal{A}_2 \rightarrow \mathcal{A}_1$ as follows. For every $U \in \mathcal{A}_2$ choose an element $f(U) \in \mathcal{A}_1$ such that $U \subseteq f(U)$.

For all $S \in \mathcal{A}_1$, let $V(S)$ be the union of all $U \in \mathcal{A}_2$ that satisfy $f(U) = S$ and finally let $\mathcal{V} := \{V(S)\}_{S \in \mathcal{A}_1}$. Then, \mathcal{V} is an open cover of X : For if $x \in X$, then $x \in U$ for some $U \in \mathcal{A}_2$ and because $U \subseteq V(f(U))$, we can deduce $x \in V(f(U))$. Furthermore, \mathcal{V} refines \mathcal{A}_1 , because $V(S) \subseteq S$ for every $S \in \mathcal{A}_1$. Since \mathcal{A}_1 refines \mathcal{U} , the cover \mathcal{V} must refine \mathcal{U} .

Finally, we need to show that \mathcal{V} has order at most d . Suppose $x \in V(S_1) \cap \dots \cap V(S_k)$, where the sets $V(S_1), \dots, V(S_k)$ are distinct. Thus, the sets S_1, \dots, S_k are distinct. For all $1 \leq i \leq k$, we can find a set $U_i \in \mathcal{A}_2$ such that $x \in U_i$ and $f(U_i) = S_i$, because $x \in V(S_i)$. Because S_1, \dots, S_k are distinct, so are U_1, \dots, U_k . Thus, we have the following situation:

$$x \in U_1 \cap \dots \cap U_k \subseteq V(S_1) \cap \dots \cap V(S_k) \subseteq S_1 \cap \dots \cap S_k$$

Because $X = X_1 \cup X_2$, we have $x \in X_1$ or $x \in X_2$. If $x \in X_1$, then $k \leq d + 1$, because \mathcal{A}_1 has order at most d in X_1 . If $x \in X_2$, we can also conclude $k \leq d + 1$, because \mathcal{A}_2 has order at most d in X_2 .

Thus, $k \leq d + 1$, proving that \mathcal{V} has order at most d , as desired. \square

A simple induction argument then yields the following corollary.

COROLLARY 3.19. *Let X be a topological space and let $X_1, \dots, X_r \subseteq X$ be closed finite-dimensional subspaces of X such that*

$$X = \bigcup_{i=1}^r X_i.$$

Then X is also finite-dimensional and

$$\dim X = \max\{\dim X_1, \dots, \dim X_n\}.$$

We can now apply these results to manifolds.

COROLLARY 3.20. *Let M be a topological n -manifold. If $C \subseteq X$ is compact, then $\dim C \leq n$.*

Proof. Since M is locally Euclidean, C can be covered by finitely many compact n -balls $B_1, \dots, B_k \subseteq M$. By Theorem 1.4 and Lemma 1.5

$$\dim(B_j \cap C) \leq \dim B_j \leq n$$

(note that B_j is homeomorphic to a compact subset of \mathbb{R}^n) for all $1 \leq j \leq k$.

Since $C = \bigcup_{j=1}^k (B_j \cap C)$, Corollary 1.7 yields $\dim C \leq n$. \square

As a special case, we can note that every compact n -manifold is finite-dimensional and its topological dimension is at most n . In fact, this result can be extended to general n -manifolds. For this, we need a technical lemma.

LEMMA 3.21. *Let X be a topological space and assume $X = \bigcup_{i=0}^{\infty} C_i$, where every C_i is closed, $C_0 = \emptyset$, $C_i \subseteq C_{i+1}$ and there exists some $d \in \mathbb{N}_0$ such that $\dim C_{i+1} \setminus C_i \leq d$ for all $i \in \mathbb{N}_0$. Then X is finite-dimensional and $\dim X \leq d$.*

Proof. We will construct a sequence of covers $(\mathcal{V}_i)_{i \in \mathbb{N}_0}$ of X such that \mathcal{V}_{i+1} refines \mathcal{V}_i and \mathcal{V}_i has order at most d in C_i and $\mathcal{V}_0 := \mathcal{U}$. Under these hypotheses,

$$\mathcal{V} := \{V \subseteq X \mid \exists i \in \mathbb{N}: V \in \mathcal{V}_i \text{ and } V \cap C_{i-1} \neq \emptyset\}$$

is a refinement of \mathcal{U} of order at most d : Let $x \in X$. Then $x \in C_{i-1}$ for some $i \in \mathbb{N}$. Since \mathcal{V}_i is an open cover of X , we get $x \in V$ for some $V \in \mathcal{V}_i$. But this means $V \cap C_{i-1} \neq \emptyset$ and hence $V \in \mathcal{V}$, proving that \mathcal{V} is an open cover of X . Suppose now that U_1, \dots, U_k are distinct elements of \mathcal{V} having nonempty intersection and let x be an element of their intersection. Then, there exists some $i_0 \in \mathbb{N}$ such that $x \in C_{i_0-1}$. For each $1 \leq j \leq k$, there exists some $i_j \in \mathbb{N}$ such that $U_j \in \mathcal{V}_{i_j}$ and $U_j \cap C_{i_j-1} \neq \emptyset$. Letting $i := \max\{i_0, i_1, \dots, i_k\}$, we get $U_1, \dots, U_k \in \mathcal{V}_i$ and

$$x \in \bigcap_{j=1}^k U_j \cap C_i.$$

Since \mathcal{V}_i has order at most d in C_i , we get $k \leq d + 1$, i.e. \mathcal{V} has order at most d , as desired.

All that is left now is constructing the sequence $(\mathcal{V}_i)_{i \in \mathbb{N}}$. Set $\mathcal{V}_0 = \mathcal{U}$ and suppose $\mathcal{V}_1, \dots, \mathcal{V}_i$ have already been constructed. Just as in the proof of Theorem 1.6 we can find a refinement \mathcal{W} of \mathcal{V}_i that has order at most d in $\overline{C_{i+1}} \setminus C_i$. Define a map $f: \mathcal{W} \rightarrow \mathcal{V}_i$ by choosing $f(W)$ such that $W \subseteq f(W)$ for all $W \in \mathcal{W}$. For $U \in \mathcal{V}_i$, we define $V(U)$ to be the union of all $W \in \mathcal{W}$ such that $f(W) = U$. We define \mathcal{V}_{i+1} to consist of three types of set: \mathcal{V}_{i+1} contains all $U \in \mathcal{V}_i$ such that $U \cap C_{i-1} \neq \emptyset$. Furthermore, \mathcal{V}_{i+1} contains all $V(U)$ where $U \in \mathcal{V}_i$ such that $U \cap C_{i-1} = \emptyset$ and $U \cap C_i \neq \emptyset$. Finally, \mathcal{V}_{i+1} contains all $W \in \mathcal{W}$ such that $W \cap C_i \neq \emptyset$.

CLAIM. \mathcal{V}_{i+1} is a refinement of \mathcal{V}_i that has order at most d in C_{i+1} .

Proof. Let $x \in X$. We need to show the existence of some $U \in \mathcal{V}_{i+1}$ satisfying $x \in U$.

Suppose $x \in C_{i-1}$. Since \mathcal{V}_i is an open cover of X , we have $x \in U$ for some $U \in \mathcal{V}_i$. Because of $U \cap C_{i-1} \neq \emptyset$, we can conclude $U \in \mathcal{V}_{i+1}$. If $x \notin C_{i-1}$, we can find $W \in \mathcal{W}$ satisfying $x \in W$. If $W \cap C_i = \emptyset$, then $W \in \mathcal{V}_{i+1}$. Otherwise, $f(W) \subseteq W$. If $f(W) \cap C_{i-1} \neq \emptyset$, then $x \in f(W) \in \mathcal{V}_{i+1}$. If $f(W) \cap C_{i-1} = \emptyset$, then $x \in V(f(W))$ and $V(f(W)) \in \mathcal{V}_{i+1}$, because $f(W) \cap C_{i-1} = \emptyset$ and $\emptyset \neq W \cap C_i \subseteq f(W) \cap C_i$.

In conclusion, \mathcal{V}_{i+1} is an open cover of X . It is obvious that \mathcal{V}_{i+1} refines \mathcal{V}_i .

Now let $U_1, \dots, U_k \in \mathcal{V}_{i+1}$ be k distinct subsets of \mathcal{V}_{i+1} and suppose $x \in C_{i+1}$ such that $x \in \bigcap_{j=1}^k U_j$. If $x \in C_{i-1}$, then necessarily $U_1, \dots, U_k \in \mathcal{V}_i$ by the definition of \mathcal{V}_{i+1} and thus $k \leq d + 1$, because \mathcal{V}_i has order at most d in C_i .

If $x \in C_i \setminus C_{i-1}$, then $U_1 = V(S_1), \dots, U_k = V(S_k)$ for some distinct $S_1, \dots, S_k \in \mathcal{V}_i$ satisfying $S_j \cap C_{i-1} = \emptyset$ and $S_j \cap C_i \neq \emptyset$ ($1 \leq j \leq k$). Thus,

$$x \in \bigcap_{j=1}^k V(S_j) \subseteq \bigcap_{j=1}^k S_j,$$

implying that $k \leq d + 1$, because \mathcal{V}_i has order at most d in C_i . Finally if $x \in C_{i+1} \setminus C_i$, then $U_1, \dots, U_k \in \mathcal{W}$, hence $k \leq d + 1$, because \mathcal{W} has order at most d in $\overline{C_{i+1}} \setminus C_i$. In conclusion, \mathcal{V}_{i+1} has order at most d in C_{i+1} . \square

This completes the proof of Lemma 1.9. \square

If X is a second-countable locally compact Hausdorff space, then we can decompose X as in the statement of Lemma 1.9.

LEMMA 3.22. *Every second-countable locally compact Hausdorff space X can be exhausted by compact subsets, i.e. there exist compact subsets $(C_i)_{i \in \mathbb{N}}$ such that $C_i \subseteq C_{i+1}$ and $X = \bigcup_{i=1}^{\infty} C_i$.*

Proof. Let \mathcal{B} be a countable basis of the topology of X and let

$$\mathcal{B}' := \{V \in \mathcal{B} \mid \overline{V} \text{ is compact}\}.$$

Since X is locally compact, \mathcal{B}' is again a basis of X . Let us now write $\mathcal{B}' = \{V_i\}_{i \in \mathbb{N}}$. Let $C_1 := \overline{V_1}$. Assume now, that compact subsets C_1, \dots, C_k satisfying $V_j \subseteq C_j$ and $C_{j-1} \subseteq C_j$ for all $1 \leq j \leq k$ (where $C_0 := \emptyset$) have already been constructed. Because C_k is compact, there exists some $m_k \leq k + 1$ satisfying $C_k \subseteq \bigcup_{j=1}^{m_k} V_j$. Letting $C_{k+1} := \bigcup_{j=1}^{m_k} \overline{V_j}$, we see that C_{k+1} is compact and $C_k \subseteq C_{k+1}$ as well as $V_{k+1} \subseteq C_{k+1}$. Thus $(C_i)_{i \in \mathbb{N}}$ is an exhaustion of X by compact subsets. \square

Now, we can finally prove that all topological manifolds are finite-dimensional.

THEOREM 3.23. *Let M be a topological n -manifold. Then M is finite-dimensional and $\dim M \leq n$.*

Proof. Since M is a second-countable locally compact Hausdorff space, M can be exhausted by compact subsets $(C_i)_{i \in \mathbb{N}}$. Each C_i is closed and furthermore each $\overline{C_{i+1}} \setminus C_i$ is compact since $\overline{C_{i+1}} \setminus C_i \subseteq C_{i+1}$. Thus, $\dim \overline{C_{i+1}} \setminus C_i \leq n$ by Corollary 1.8. Lemma 1.9 now yields $\dim M \leq n$. \square

3.3. The embedding theorem

We want to make use of the fact that manifolds are finite-dimensional. The aim of this section is the proof of the following statement.

THEOREM 3.24. *Let X be a second-countable locally compact Hausdorff space such that every compact subspace of X has dimension at most $n \in \mathbb{N}$. Then X admits a closed embedding $\iota: X \hookrightarrow \mathbb{R}^{2n+1}$.*

Since every n -manifold M is a second-countable locally compact Hausdorff space such that $\dim C \leq n$ for all compact $C \subseteq M$, we can thus conclude that M admits a closed embedding $M \hookrightarrow \mathbb{R}^{2n+1}$.

If X is a topological space, we denote by $C(X, \mathbb{R}^N)$ the set of all continuous maps $X \rightarrow \mathbb{R}^N$. We shall equip \mathbb{R}^N with the metric

$$\delta(x, y) := \min\{1, \|x - y\|_{\infty}\},$$

where $x, y \in \mathbb{R}^N$. Then δ induces the same topology on \mathbb{R}^N as $\|\cdot\|_{\infty}$ and (\mathbb{R}^N, δ) is a complete metric space. We equip $C(X, \mathbb{R}^N)$ with the metric

$$\rho(f, g) := \sup_{x \in X} \delta(f(x), g(x)),$$

where $f, g \in C(X, \mathbb{R}^N)$. Since (\mathbb{R}^N, δ) is complete, so is $(C(X, \mathbb{R}^N), \rho)$.

Our proof of Theorem 2.1 is based on [Mun00b, p. 315, Exercise 6].

Definition 3.25. Let X be a topological space and let $f \in C(X, \mathbb{R}^N)$. We write $f(x) \xrightarrow{x \rightarrow \infty} \infty$, if for all $R > 0$ there exists some compact subset $C \subseteq X$ such that $\|f(x)\|_\infty > R$ for all $x \in X \setminus C$.

Remark 3.26. Note that $f(x) \xrightarrow{x \rightarrow \infty} \infty$ whenever X is compact.

LEMMA 3.27. Let X be a topological space and let $f, g \in C(X, \mathbb{R}^N)$ such that $\rho(f, g) < 1$ and $f(x) \xrightarrow{x \rightarrow \infty} \infty$. Then also $g(x) \xrightarrow{x \rightarrow \infty} \infty$.

Proof. Let $R > 0$. There exists some compact subset $C \subseteq X$ such that $\|f(x)\|_\infty > R + 1$ whenever $x \in X \setminus C$. The triangle inequality yields

$$\|f(x)\|_\infty \leq \|g(x)\|_\infty + \|f(x) - g(x)\|_\infty < \|g(x)\|_\infty + 1$$

and hence $\|g(x)\|_\infty > R$ whenever $x \in X \setminus C$. This proves $g(x) \xrightarrow{x \rightarrow \infty} \infty$. \square

LEMMA 3.28. Let $f \in C(X, \mathbb{R}^N)$ such that $f(x) \xrightarrow{x \rightarrow \infty} \infty$. Then f is proper, i.e. $f^{-1}(K)$ is compact whenever $K \subseteq \mathbb{R}^N$ is compact. If f is injective as well, then f is also a closed embedding.

Proof. Let $K \subseteq \mathbb{R}^N$ be compact. Thus, $K \subseteq [-R, R]^N$ for some $R > 0$. We can find a compact subset $C \subseteq X$ such that $\|f(x)\|_\infty > R$ whenever $x \in X \setminus C$. Therefore, $f^{-1}(K) \subseteq f^{-1}([-R, R]^N) \subseteq C$. This shows that $f^{-1}(K)$ is compact as a closed subset of the compact space C . Therefore, f is proper.

Since f is proper and \mathbb{R}^N is locally compact Hausdorff, f must also be closed. Thus, if f is injective, then it will be a closed embedding. \square

Suppose X is a second-countable locally compact Hausdorff space. We can choose a metric d on X that induces the topology of X (see [Bre97, Chapter I, Theorem 12.12]). For every $f \in C(X, \mathbb{R}^N)$ and $C \subseteq X$ compact, we let

$$\Delta(f, C) := \sup_{z \in f(C)} \text{diam } f^{-1}(\{z\}).$$

LEMMA 3.29. Given $\varepsilon > 0$ and $C \subseteq X$ compact, we let

$$U_\varepsilon(C) := \{f \in C(X, \mathbb{R}^N) \mid \Delta(f, C) < \varepsilon\}.$$

Then $U_\varepsilon(C)$ is open in $C(X, \mathbb{R}^N)$.

Proof. Let $f \in U_\varepsilon(C)$ and let $b > 0$ such that $\Delta(f, C) < b < \varepsilon$. Furthermore, let

$$A := \{(x, y) \in C \times C \mid d(x, y) \geq b\}.$$

Since A is closed in the compact space $C \times C$, A is also compact. The continuous map

$$X \times X \rightarrow \mathbb{R}, (x, y) \mapsto \delta(f(x), f(y))$$

is strictly positive on A and thus $r := \frac{1}{2} \cdot \min_{(x, y) \in A} \delta(f(x), f(y))$ satisfies $r > 0$. We will show that $B_\rho(f, r) \subseteq U_\varepsilon(C)$: Let $g \in B_\rho(f, r)$, i.e. $\rho(f, g) < r$. If $(x, y) \in A$, then $\delta(f(x), f(y)) \geq 2r$. Since $\delta(f(x), g(x)) < r$ and $\delta(f(y), g(y)) < r$, we get $g(x) \neq g(y)$. Thus, by contraposition, if $g(x) = g(y)$ for some $x, y \in C$, then $(x, y) \notin A$ and thus $d(x, y) < b$.

This shows $\Delta(g, C) \leq b < \varepsilon$. \square

We recall the notion of affine independence.

Definition 3.30. A set of points $S \subseteq \mathbb{R}^N$ is *affinely independent* if for all distinct $p_0, \dots, p_k \in S$ and $\alpha_0, \dots, \alpha_k \in \mathbb{R}$, the equations

$$\sum_{i=0}^k \alpha_i \cdot p_i = 0 \quad \text{and} \quad \sum_{i=0}^k \alpha_i = 0$$

imply that $\alpha_0 = \dots = \alpha_k = 0$.

Geometrically speaking, if $S \subseteq \mathbb{R}^N$ is affinely independent and $\text{card}(S) = k$, then the points of S uniquely determine a k -plane in \mathbb{R}^N .

LEMMA 3.31. *Let $x_1, \dots, x_n \in \mathbb{R}^N$ be distinct points and let $r > 0$. Then, there exist distinct points $y_1, \dots, y_n \subseteq \mathbb{R}^N$ such that:*

- (1) $\|x_i - y_i\|_\infty < r$ for all $1 \leq i \leq n$.
- (2) $\{y_1, \dots, y_n\}$ is in general position, i.e. every subset $S \subseteq \{y_1, \dots, y_n\}$ such that $\text{card}(S) \leq N + 1$ is affinely independent.

Proof. We construct the points y_1, \dots, y_n inductively. Let $y_1 := x_1$. Now, suppose y_1, \dots, y_k have already been constructed and are in general position as well as $\|x_i - y_i\|_\infty < r$ for all $1 \leq i \leq k$. Consider the union P of all the affine subspaces that are generated by subsets $A \subseteq \{y_1, \dots, y_k\}$ such that $\text{card}(A) \leq N$. Since every l -plane in \mathbb{R}^N is closed and has empty interior whenever $l < N$, we can deduce $\overset{\circ}{P} = \emptyset$, because \mathbb{R}^N is a Baire space as a complete metric space (see [Bre97, Chapter I, Theorem 17.1]). Choose any $y_{k+1} \in \mathbb{R}^N \setminus P$ satisfying $\|x_{k+1} - y_{k+1}\|_\infty < r$. This process yields the sought points y_1, \dots, y_n . \square

Another fact from point-set topology that we need are partitions of unity. We shall only state the result here and omit the proof.

THEOREM 3.32. *Let X be a paracompact space and let $\mathcal{U} = \{U_i\}_{i \in I}$ be an open cover of X . Then there exists a partition of unity $\{\phi_i\}_{i \in I}$ subordinate to \mathcal{U} , i.e.*

- (1) Each $\phi_i: X \rightarrow [0, 1]$ is a continuous map.
- (2) $\text{supp } \phi_i \subseteq U_i$ for all $i \in I$.
- (3) $\{\text{supp } \phi_i\}_{i \in I}$ is locally finite, i.e. each point $x \in X$ has a neighbourhood that intersects only finitely many of the $\{\text{supp } \phi_i\}_{i \in I}$.
- (4) $\sum_{i \in I} \phi_i(x) = 1$ for all $x \in X$.

For a proof see [Mun00b, Theorem 41.7]. Recall that second-countable locally compact Hausdorff spaces are paracompact.

LEMMA 3.33. *Suppose, X is a second-countable locally compact Hausdorff space such that every compact subspace of X has topological dimension at most $n \in \mathbb{N}$. If $\emptyset \neq C \subseteq X$ is compact, then $U_\varepsilon(C)$ is dense in $C(X, \mathbb{R}^N)$ for every $\varepsilon > 0$.*

Proof. Choose a metric d on X and let $f \in C(X, \mathbb{R}^{2n+1})$ and let $1 > r > 0$. We need to find a $g \in U_\varepsilon(C)$ satisfying $\rho(f, g) \leq r$. Since C is compact, we can cover C by finitely many open (open in C) sets $U_1, \dots, U_m \subseteq C$ such that

- (1) $\text{diam } U_i < \frac{\varepsilon}{2}$ for all $1 \leq i \leq m$,
- (2) $\text{diam } f(U_i) \leq \frac{r}{2}$ for all $1 \leq i \leq m$,
- (3) $\{U_1, \dots, U_m\}$ has order at most n .

Let $\{\phi_1, \dots, \phi_m\}$ be a partition of unity subordinate to $\{U_1, \dots, U_m\}$. For each $1 \leq i \leq m$ choose a point $x_i \in U_i$. Then choose $z_1, \dots, z_m \in \mathbb{R}^{2n+1}$ such that $\|f(x_i) - z_i\|_\infty < \frac{r}{2}$ and $\{z_1, \dots, z_m\}$ is in general position (Lemma 2.7). Finally, let

$$\tilde{g}: C \rightarrow \mathbb{R}^{2n+1}, \quad x \mapsto \sum_{i=1}^m \phi_i(x) \cdot z_i.$$

CLAIM. $\|\tilde{g}(x) - f(x)\|_\infty < r$ for all $x \in C$.

Proof of claim. For all $x \in C$, we have

$$\tilde{g}(x) - f(x) = \sum_{i=1}^m \phi_i(x) \cdot (z_i - f(x_i)) + \sum_{i=1}^m \phi_i(x) \cdot (f(x_i) - f(x)),$$

where we have used $\sum_{i=1}^m \phi_i(x) = 1$. We have $\|z_i - f(x_i)\|_\infty < \frac{r}{2}$ for all $1 \leq i \leq m$. Also if $\phi_i(x) \neq 0$, then $x \in U_i$ and since $\text{diam } f(U_i) < \frac{r}{2}$, we can conclude $\|f(x_i) - f(x)\|_\infty < \frac{r}{2}$. Thus,

$$\|\tilde{g}(x) - f(x)\|_\infty < \sum_{i=1}^m \phi_i(x) \cdot \frac{r}{2} + \sum_{i=1}^m \phi_i(x) \cdot \frac{r}{2} = r.$$

□

CLAIM. If $x, y \in C$ satisfy $\tilde{g}(x) = \tilde{g}(y)$, then $d(x, y) < \frac{\varepsilon}{2}$.

Proof of claim. We will prove that $\tilde{g}(x) = \tilde{g}(y)$ implies $x, y \in U_i$ for some $1 \leq i \leq m$. Since $\text{diam } U_i < \frac{\varepsilon}{2}$, the claim follows.

$\tilde{g}(x) = \tilde{g}(y)$ implies $\sum_{i=1}^m (\phi_i(x) - \phi_i(y)) \cdot z_i = 0$. Because the cover $\{U_1, \dots, U_m\}$ has order at most n , at most $n+1$ of the numbers $\phi_1(x), \dots, \phi_m(x)$ and at most $n+1$ of the numbers $\phi_1(y), \dots, \phi_m(y)$ are non zero. Letting

$$S := \{z_i \mid 1 \leq i \leq m \text{ and } \phi_i(x) - \phi_i(y) \neq 0\},$$

we can deduce $\text{card}(S) \leq 2n+2$. Note that $\sum_{i=1}^m (\phi_i(x) - \phi_i(y)) = 0$ and since $\{z_1, \dots, z_m\} \subseteq \mathbb{R}^{2n+1}$ are in general position and $\text{card}(S) \leq 2n+1+1$, we can conclude $\phi_i(x) - \phi_i(y) = 0$ for all $1 \leq i \leq m$. Since $\phi_i(x) > 0$ for some $1 \leq i \leq m$, we get $\phi_i(x) = \phi_i(y) > 0$ and thus $x, y \in U_i$. □

In conclusion,

$$h: C \rightarrow [-r, r]^{2n+1}, \quad x \mapsto f(x) - \tilde{g}(x)$$

is a well-defined continuous map. As a locally compact Hausdorff space, X is also normal. Thus, we can apply the Tietze extension theorem (see [Mun00b, Theorem 35.1]): h can be extended to a continuous map $H: X \rightarrow [-r, r]^{2n+1}$. Letting

$$g: X \rightarrow \mathbb{R}^{2n+1}, \quad x \mapsto f(x) - H(x),$$

we have $g|_C = \tilde{g}$ and thus $\Delta(g, C) \leq \frac{\varepsilon}{2} < \varepsilon$ and $\rho(f, g) \leq r$. □

Let X be as in Theorem 2.1 or Lemma 2.9 and choose a metric d on X . Since $(C(X, \mathbb{R}^{2n+1}), \rho)$ is a Baire space, every intersection of countably many open dense subsets of $C(X, \mathbb{R}^{2n+1})$ is again dense in $C(X, \mathbb{R}^{2n+1})$. Consider an exhaustion of X by compact subsets $(C_k)_{k \in \mathbb{N}}$ (Lemma 1.10). Then the set $\bigcap_{k=1}^\infty U_{1/k}(C_k)$ is dense in $C(X, \mathbb{R}^{2n+1})$.

LEMMA 3.34. Every $f \in \bigcap_{k=1}^\infty U_{1/k}(C_k)$ is injective.

Proof. Let $x, y \in X$ such that $f(x) = f(y)$. There exists some $k_0 \in \mathbb{N}$ such that $x, y \in C_k$ whenever $k \geq k_0$. Because $f \in U_{1/k}(C_k)$, we get $d(x, y) \leq \frac{1}{k}$ for all $k \geq k_0$. Hence, $d(x, y) = 0$ and therefore $x = y$. □

LEMMA 3.35. If X is a second-countable locally compact Hausdorff space, then there exists a map $f \in C(X, \mathbb{R}^N)$ such that $f(x) \xrightarrow{x \rightarrow \infty} \infty$.

Proof. It suffices to consider the case $N = 1$. Let $\{U_k\}_{k \in \mathbb{N}}$ be cover of X by open sets such that $\overline{U_k}$ is compact for each $k \in \mathbb{N}$. Since X is second-countable locally compact Hausdorff, X is paracompact and we can find a partition of unity $\{\phi_k\}_{k \in \mathbb{N}}$ subordinate to $\{U_k\}_{k \in \mathbb{N}}$. Letting

$$f: X \rightarrow \mathbb{R}, \quad x \mapsto \sum_{k=1}^\infty k \cdot \phi_k(x),$$

we see that $f(x) \xrightarrow{x \rightarrow \infty} \infty$. □

We can now proceed to the proof of Theorem 2.1.

Proof. Begin with a continuous map $f: X \rightarrow \mathbb{R}^{2n+1}$ such that $f(x) \xrightarrow{x \rightarrow \infty} \infty$ from Lemma 2.11. Consider an exhaustion of X by compact subsets $(C_k)_{k \in \mathbb{N}}$ (Lemma 1.10). Since $\bigcap_{k=1}^{\infty} U_{1/k}(C_k)$ is dense in $C(X, \mathbb{R}^{2n+1})$, we can find $\iota \in \bigcap_{k=1}^{\infty} U_{1/k}(C_k)$ such that $\rho(f, \iota) < 1$. Then ι is injective by Lemma 2.10 and $\iota(x) \xrightarrow{x \rightarrow \infty} \infty$ by Lemma 2.3. Then, $\iota: M \hookrightarrow \mathbb{R}^{2n+1}$ is a closed embedding by Lemma 2.4, as desired. □

3.4. ANRs and ENRs

Definition 3.36. A topological space X is called an *Absolute Neighbourhood Retract (ANR)* if for every paracompact space P and every continuous map $f: A \rightarrow X$, where $A \subseteq P$ is closed, there exists an extension $\bar{f}: W \rightarrow X$ of f where W is an open neighbourhood of A .

Why are we interested in ANRs? In this section, we want to prove the following.

THEOREM 3.37. *Every topological manifold is an ANR.*

Why do we want to prove this? Here is the reason.

THEOREM 3.38. *Every topological manifold is an ENR.*

Proof. Let M be a topological n -manifold and let $\iota: M \hookrightarrow \mathbb{R}^{2n+1}$ be a closed embedding. Because M is an ANR by Theorem 3.2, so is $\iota(M)$. Since $\iota(M) \subseteq \mathbb{R}^{2n+1}$ and \mathbb{R}^{2n+1} is paracompact, the map $f: \iota(M) \rightarrow \iota(M)$, $x \mapsto x$ can be extended to a map $r: U \rightarrow \iota(M)$ where U is an open neighbourhood of $\iota(M)$. This r is a retraction. □

We will prove Theorem 3.2 by a series of lemmas and we will follow [KK].

LEMMA 3.39. *Every open subset of an ANR is again an ANR.*

Proof. Let X be an ANR and let $U \subseteq X$ be open. Let $f: A \rightarrow U$ be continuous where $A \subseteq P$ is closed, P is paracompact. Letting $\tilde{f} := i \circ f$, where $i: U \hookrightarrow X$ is the standard embedding, \tilde{f} can be extended to a map $\bar{f}: W \rightarrow X$, where W is an open neighbourhood of A . Then, $\bar{f}|_{\bar{f}^{-1}(U)}$ is the sought extension. □

LEMMA 3.40. *Let X be paracompact and assume further $\dim X \leq n$. If \mathcal{U} is an open cover of X , there exist $n+1$ collections of open subsets $\mathcal{V}_0, \dots, \mathcal{V}_n$ such that $\mathcal{V} := \bigcup_{k=0}^n \mathcal{V}_k$ is a locally finite refinement of \mathcal{U} .*

Proof. Since $\dim X \leq n$, we can assume that $\mathcal{U} = \{U_i\}_{i \in I}$ has order at most n . Let $\{\phi_i\}$ be a partition of unity subordinate to \mathcal{U} . For each $i \in I$, we let

$$V_i := \{x \in X \mid \forall j \in I \setminus \{i\}: \phi_i(x) > \phi_j(x)\}.$$

Then $V_i \subseteq \text{supp } \phi_i \subseteq U_i$ and $V_i \cap V_j = \emptyset$ whenever $i \neq j$. Let $\mathcal{V}_0 := \{V_i\}_{i \in I}$.

Now let $0 \leq k \leq n$ and let $i_0, \dots, i_k \in I$ be distinct indices. Let

$$V_{i_0, \dots, i_k} := \{x \in X \mid \phi_i(x) > \phi_j(x) \text{ whenever } i \in \{i_0, \dots, i_k\} \text{ and } j \notin \{i_0, \dots, i_k\}\}$$

Note that $V_{i_0, \dots, i_k} \cap V_{j_0, \dots, j_k} = \emptyset$ whenever $\{i_0, \dots, i_k\} \neq \{j_0, \dots, j_k\}$, because for $i \in \{i_0, \dots, i_k\} \setminus \{j_0, \dots, j_k\}$ and $j \in \{j_0, \dots, j_k\} \setminus \{i_0, \dots, i_k\}$ we have $\phi_i(x) > \phi_j(x)$ for all $x \in V_{i_0, \dots, i_k}$ and $\phi_j(y) > \phi_i(y)$ for all $y \in V_{j_0, \dots, j_k}$.

Define \mathcal{V}_k be the set of all such V_{i_0, \dots, i_k} and let $\mathcal{V} := \bigcup_{k=0}^n \mathcal{V}_k$.

We need to show that \mathcal{V} covers X . Let $x \in X$ and let $J := \{i \in I \mid \phi_i(x) > 0\}$. Then, $\text{card}(J) \leq n + 1$ since \mathcal{U} has order at most n . Writing $J = \{j_0, \dots, j_k\}$, we get $x \in V_{j_0, \dots, j_k}$. Obviously, \mathcal{V} is a refinement of \mathcal{U} . It only remains to show that \mathcal{V} is locally finite. Let $x \in X$. There exists a neighbourhood N of x that intersects only finitely many of the $\{\text{supp } \phi_i\}_{i \in I}$. Let $J := \{i \in I \mid \text{supp } \phi_i \cap N \neq \emptyset\}$. Then $\text{card}(J) < \infty$. Assume $V_{j_0, \dots, j_k} \in \mathcal{V}$ intersects N . Let $y \in N \cap V_{j_0, \dots, j_k}$. Then $\phi_{j_l}(y) > 0$ for all $1 \leq l \leq k$. Thus $\{j_0, \dots, j_k\} \subseteq J$. But there are only finitely many subsets of J and hence only finitely many elements of \mathcal{V} intersect N . \square

LEMMA 3.41. *Let X be paracompact space and let $\mathcal{U} := \{U_i\}_{i \in I}$ be an open cover of X . Then there exists a locally finite cover $\mathcal{V} = \{V_i\}_{i \in I}$ of X satisfying $\overline{V_i} \subseteq U_i$ for all $i \in I$.*

For a proof see [Mun00b, Lemma 41.6].

The following lemma is needed for local-to-global results.

LEMMA 3.42. *Let X be a paracompact space and suppose $\dim X \leq n$. Let \mathcal{U} be an open cover of X satisfying the following.*

- (1) *If $V \subseteq X$ is open and $V \subseteq U$ for some $U \in \mathcal{U}$, then $V \in \mathcal{U}$.*
- (2) *If $V \subseteq \mathcal{U}$ and $V_1 \cap V_2 = \emptyset$ for any $V_1, V_2 \in \mathcal{V}$ such that $V_1 \neq V_2$, then $\bigcup_{V \in \mathcal{V}} V \in \mathcal{U}$.*
- (3) *If $U_1, U_2 \in \mathcal{U}$ and $V_1, V_2 \subseteq X$ are open and $\overline{V_1} \subseteq U_1, \overline{V_2} \subseteq U_2$, then $V_1 \cup V_2 \in \mathcal{U}$.*

Then $X \in \mathcal{U}$.

Proof. Let $\mathcal{V} := \bigcup_{k=0}^n \mathcal{V}_k$ as in Lemma 3.5. Since \mathcal{V} is a refinement of \mathcal{U} , we have $\mathcal{V} \subseteq \mathcal{U}$ by (1). Thus, by (2), we have $V_k := \bigcup_{V \in \mathcal{V}_k} V \in \mathcal{U}$ for all $0 \leq k \leq n$. Then $\{V_k\}_{0 \leq k \leq n}$ is an open cover of X by $n + 1$ elements of \mathcal{U} . By Lemma 3.6, there exists an open cover $\{W_k\}_{0 \leq k \leq n}$ of X satisfying $\overline{W_k} \subseteq V_k$ for all $0 \leq k \leq n$. Then $W_0 \cup W_1 \in \mathcal{U}$ by (3). By using (1), we see that $\{W_0 \cup W_1, \dots, W_n\}$ is an open cover of X by n elements of \mathcal{U} . Repeat this process with $\{W_0 \cup W_1, \dots, W_n\}$ instead of $\{V_k\}_{0 \leq k \leq n}$ to get a covering of X by $n - 1$ elements of \mathcal{U} and so on until X is covered by one element of \mathcal{U} , which eventually yields $X \in \mathcal{U}$. \square

Before we proceed to the proof of Theorem 3.2, we should notice that the closed unit interval I is an ANR as a consequence of the Tietze extension theorem and hence so is I^n for any $n \in \mathbb{N}_0$. We now come to the proof of Theorem 3.2.

Proof of Theorem 3.2. Let M be a topological n -manifold and let \mathcal{U} be the collection of all open subsets of M which are ANRs. Then, \mathcal{U} is an open cover of M since every point $p \in M$ lies in a neighbourhood that is homeomorphic to an open subset of I^n and is thus an ANR by Lemma 3.4.

We will be done, once we show that \mathcal{U} satisfies the conditions (1) - (3) in Lemma 3.7. Condition (1) is met since every open subset of an ANR is again an ANR.

For condition (2) consider a subset $\mathcal{V} := \{V_i\}_{i \in I}$ of \mathcal{U} that consists of disjoint sets and let $f: A \rightarrow V := \bigcup_{i \in I} V_i$ be a continuous map where A is a closed subset of a paracompact space P . Each V_i is clopen in V since the $\{V_i\}_{i \in I}$ are disjoint. Thus, $A_i := f^{-1}(V_i)$ is closed in P for each $i \in I$ as is $\bigcup_{i \in J} A_i$ for all $J \subseteq I$.

If we can find a disjoint collection of open sets $\{W_i\}_{i \in I}$ of P such that $A_i \subseteq W_i$ for all $i \in I$, we will be done: Then we can extend $f|_{A_i}: A_i \rightarrow V_i$ to $\tilde{f}_i: W'_i \rightarrow V_i$, where W'_i is open in P (because V_i is an ANR) and define $W := \bigcup_{i \in I} (W_i \cap W'_i)$ as well as $\tilde{f}: W \rightarrow V$ by $\tilde{f}|_{W_i \cap W'_i} := \tilde{f}_i|_{W_i \cap W'_i}$.

CLAIM. *If P is paracompact and $\{A_i\}_{i \in I}$ is a disjoint collection of closed sets such that $\bigcup_{i \in J} A_i$ is closed for any $J \subseteq I$, then there exists a disjoint collection $\{W_i\}_{i \in I}$ of open sets such that $A_i \subseteq W_i$ for all $i \in I$.*

Proof of the claim. P is normal as a paracompact space and thus we can find open sets $\{Y_i\}_{i \in I}$ such that $A_i \subseteq Y_i$ and $\overline{Y_i} \cap \bigcup_{j \in I \setminus \{i\}} A_j = \emptyset$. Let $A := \bigcup_{i \in I} A_i$. Then $\{Y_i\}_{i \in I} \cup \{P \setminus A\}$ is an

open cover of P . By Lemma 3.6, there is a locally finite open cover $\{Z_i\}_{i \in I} \cup \{Z\}$ such that $\bar{Z}_i \subseteq Y_i$ for all $i \in I$ and $\bar{Z} \subseteq P \setminus A$. By local finiteness, the equality $\bigcup_{j \in J} \bar{Z}_j = \overline{\bigcup_{j \in J} Z_j}$ holds for any $J \subseteq I$, hence $\bigcup_{j \in J} \bar{Z}_j$ is closed. Thus, $W_i := Z_i \setminus \bigcup_{j \in I \setminus \{i\}} \bar{Z}_j$ is an open set such that $A_i \subseteq W_i$ and the $\{W_i\}_{i \in I}$ are disjoint. \square

This proves condition (2). All that is left is proving condition (3). Let $U_1, U_2 \in \mathcal{U}$ and let $V_1, V_2 \subseteq M$ be open such that $\bar{V}_1 \subseteq U_1$ and $\bar{V}_2 \subseteq U_2$. We need to show that $V_1 \cup V_2 \in \mathcal{U}$, i.e. $V_1 \cup V_2$ is an ANR.

Let $f: A \rightarrow V_1 \cup V_2$ be continuous, where A is a closed subset of a paracompact space P . Let $B_0 := f^{-1}(\bar{V}_1 \cap \bar{V}_2)$, $B_1 := f^{-1}(\bar{V}_1)$, $B_2 := f^{-1}(\bar{V}_2)$. Then, B_0, B_1 and B_2 are closed subsets of P . Let $A_0 := f^{-1}(U_1 \cup U_2)$. Then A_0 is open in A , hence there exists some open subset $X_0 \subseteq P$ such that $A_0 = X_0 \cap P$. Because P is normal as a paracompact space, we can find an open subset $Y_0 \subseteq P$ such that $B_0 \subseteq Y_0 \subseteq \bar{Y}_0 \subseteq X_0$.

Since $f(\bar{Y}_0 \cap A) \subseteq U_1 \cup U_2$ and $U_1 \cap U_2$ is an ANR, we can extend $f|_{\bar{Y}_0 \cap A}$ to a map $\bar{f}_0: Z_0 \rightarrow U_1 \cap U_2$ where Z_0 is an open neighbourhood of $\bar{Y}_0 \cap A$. Use normality again to find an open set $W_0 \subseteq P$ such that $B_0 \subseteq W_0 \subseteq \bar{W}_0 \subseteq Y_0 \cap Z_0$.

Thus \bar{f}_0 is defined on \bar{W}_0 and extends $f|_{\bar{W}_0 \cap A}$. For $i \in \{1, 2\}$, let $f_i: B_i \cup \bar{W}_0 \rightarrow U_i$ be defined by $f_i(x) := f(x)$ for all $x \in B_i$ and $f_i(x) := \bar{f}_0(x)$ for all $x \in \bar{W}_0$. We can extend f_i to $\bar{f}_i: Z_i \rightarrow U_i$ where Z_i is an open neighbourhood of $B_i \cup \bar{W}_0$, because U_i is an ANR.

Since

$$(B_1 \setminus W_0) \cap (B_2 \setminus W_0) = (B_1 \cap B_2) \setminus W_0 = B_0 \setminus W_0 = \emptyset,$$

and both $B_1 \setminus W_0$ and $B_2 \setminus W_0$ are closed, we can once again use normality to find disjoint open sets $W_1, W_2 \subseteq P$ such that $B_i \setminus W_0 \subseteq W_i \subseteq Z_i$ for each $i \in \{1, 2\}$.

Finally, let $\bar{f}: W_0 \cup W_1 \cup W_2 \rightarrow U_1 \cup U_2$ be defined by $\bar{f}|_{W_i} := \bar{f}_i|_{W_i}$ where $i \in \{0, 1, 2\}$. By letting $W := \bar{f}^{-1}(V_1 \cup V_2)$, we can conclude that $\bar{f}|_W$ is an extension of f to an open neighbourhood W of A . This proves (3) and therefore, M is an ANR. \square

CHAPTER 4

Collars and bicollars

Gopal Ananthakrishna and Mark Powell

The goal of this chapter is to show that the boundary of every manifold admits a collar.

Definition 4.1. A manifold M is said to have a *collared boundary* if there exists a closed embedding $C: \partial M \times [0, 1] \hookrightarrow M$ such that $(x, 0) \mapsto x$.

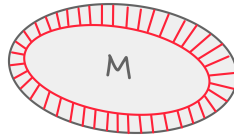

FIGURE 4.1. The red region indicates the collar.

Definition 4.2. A *submanifold* of X is a subset that is the image of a locally flat embedding.

Definition 4.3. A submanifold Y of X is said to be *two-sided* if there exists a connected neighbourhood N of Y that is separated by Y . i.e. $N \setminus Y$ has two components (see Fig. 4.2a).

Definition 4.4. A submanifold Y of X is said to be *bicollared* if $f: Y \hookrightarrow X$ can be extended to an embedding $f: Y \times [-1, 1] \hookrightarrow X$ with $(y, 0) \mapsto f(y)$.

Now that we know what a collar is, we look at a result by Morton Brown [Bro62a] which shows that boundaries of manifolds admit collars. We will present the proof of this result by Robert Connelly [Con71], which is simpler than Brown's proof.

THEOREM 4.5 (The Collaring Theorem). *Every manifold has a collared boundary.*

If $\partial M = \emptyset$, then this theorem is vacuous but still true.

COROLLARY 4.6. *Let Y be a locally flat, two-sided, without boundary, codimension one connected submanifold of X^m . Then Y is bicollared.*

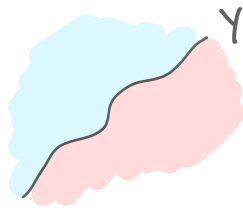

(A) Submanifold with two sides, blue and red.

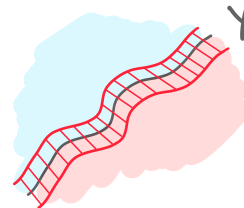

(B) Bicollaring a two-sided submanifold.

Proof. Consider a connected neighbourhood N of X cut along Y . Let $N \setminus Y = L \cup R$. Now because Y is locally flat, $L \cup Y$ and $R \cup Y$ are manifolds with boundary and thus have collars.

$$\begin{aligned} Y \times [0, 1] &\hookrightarrow R \cup Y \\ Y \times [-1, 0] &\hookrightarrow L \cup Y \end{aligned}$$

Hence, we can glue these collars to get a topological bicollar. \square

Note that the argument given does not work in the smooth category: more work would be required to glue together two smooth collars and obtain a smooth bicollar.

Now that we have seen the collaring theorem and one of its corollaries, it is time to prove the collaring theorem. First we look at an outline of the proof in the smooth category.

Outline of proof in the smooth case.

- Consider an inward pointing nonvanishing vector field on ∂M , and extend it to a vector field on M that is nonvanishing on a neighbourhood of ∂M .
- Integrate the vector field to obtain a flow. By considering a suitably small time period, the flow is defined.
- Propagating the boundary along the flow gives rise to a collar. \square

Now we prove the collaring theorem. We will consider the compact case only. The idea of the proof extends to the non-compact case, but we will not give the details here to avoid a too-lengthy side discussion of open covers.

Proof of Theorem 4.5 in the compact case. Let M be an n -dimensional compact manifold. We outline the proof.

- Add an exterior collar $\partial M \times [-1, 0]$ to M to obtain

$$M^+ := M \cup \partial M \times [-1, 0]$$

by gluing along the boundary, i.e. $x \in \partial M$ $(x, 0) \in \partial M \times \{0\}$.

- Construct a homeomorphism $G: M \rightarrow M^+$, by an induction over charts covering ∂M , gradually stretching more of a neighbourhood of ∂M in M over the exterior collar.
- The inverse image $G^{-1}(\partial M \times [-1, 0])$ gives us the desired collar.

Since ∂M is compact, there is a finite collection $U_1, \dots, U_m \subseteq \partial M$ forming an open cover of ∂M by coordinate neighbourhoods, such that for each $i = 1, \dots, m$ we can find local collars for the closures of the U_i, \bar{U}_i . Let us call these local embeddings

$$h_i: \bar{U}_i \times [0, 1] \hookrightarrow M.$$

We may suppose in addition that they satisfy

- $h_i^{-1}(\partial M) = \bar{U}_i \times \{0\}$;
- $h_i(x, 0) = x$;
- $h_i(\bar{U}_i \times [0, 1])$ is open in M .

Let $\{V_i\}_{i=1}^n$ be another cover with

$$V_i \subseteq \bar{V}_i \subseteq U_i.$$

To find such a collection of U_i, V_i and h_i , take an arbitrary collection of pairs (U_i, V_i) with the V_i covering ∂M , and with the U_i subsets of coordinate neighbourhoods so that they give local collars on \bar{U}_i . Then apply compactness to find a finite subcollection.

We will use the embeddings H_i defined as follows:

$$\begin{aligned} H_i: \bar{U}_i \times [-1, 1] &\rightarrow M^+ \\ (x, t) &\mapsto \begin{cases} h_i(x, t) & t \geq 0 \\ (x, t) & t < 0. \end{cases} \end{aligned}$$

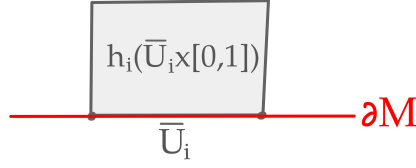

FIGURE 4.3. A local collar.

This is well-defined and continuous since $h_i(x, 0) = x$. We will build a homeomorphism $M \rightarrow M^+$ mapping ∂M to $\partial M \times \{-1\}$. Our goal is to inductively define maps $f_i: \partial M \rightarrow [-1, 0]$ and embeddings $g_i: M \rightarrow M^+$ for $i = 0, 1, \dots, m$ satisfying:

- (1) $f_i(x) = -1$ for all $x \in \bigcup_{j \leq i} \bar{V}_j$
- (2) $g_i(x) = (x, f_i(x))$ for all $x \in \partial M$
- (3) $g_i(M) = M \cup \{(x, t) \mid t \geq f_i(x)\}$.

Once this is completed, since $\bigcup_i V_j = \partial M$, we will have that $f_m(x) = -1$ for all $x \in \partial M$. Therefore $g_m(M) = M^+$, so $G := g_m$ will be our desired homeomorphism, and $g_m^{-1}(\partial M \times [-1, 0]) \subseteq M$ will be a collar. Here note that g_m^{-1} being a homeomorphism implies it is a closed map, so $g_m^{-1}(\partial M \times [-1, 0])$ will be closed. Also $g_m^{-1}(x, -1) = x$ by (2) for all $x \in \partial M$.

In the case $i = 0$ define $f_0 \equiv 0$ and define $g_0: M \rightarrow M^+$ to be the inclusion map. Now suppose for the inductive step that f_{i-1} and g_{i-1} have been defined. We will construct

$$\phi_i: H_i^{-1}g_{i-1}(M) \rightarrow \bar{U}_i \times [-1, 1],$$

embeddings that “push V_i down,” taking $H_i^{-1}g_{i-1}(M) \subseteq \bar{U}_i \times [-1, 1]$ and reembedding it in $\bar{U}_i \times [-1, 1]$ in such a way that V_i is also pushed down into the exterior collar $\partial M \times [-1, 0]$. We will require that:

$$\begin{aligned} \phi_i H_i^{-1}g_{i-1}(\bar{V}_i) &= \bar{V}_i \times \{-1\} \\ \phi_i|_{\bar{U}_i \setminus U_i \times [-1, 1] \cup \bar{U}_i \times \{1\}} &= \text{Id}. \end{aligned}$$

Find a Urysohn function $\lambda_i: \bar{U}_i \rightarrow [0, 1]$ such that λ_i is 0 on $\bar{U}_i \setminus U_i$ and is 1 on \bar{V}_i . Since ∂M is paracompact and Hausdorff it is normal [Mun00a, Theorem 41.1], so the Urysohn lemma applies to find such a continuous function.

Write

$$b(x) := (1 - \lambda_i(x))f_{i-1}(x) - \lambda_i(x).$$

For each x let $S_x: [f_{i-1}(x), 1] \rightarrow [b(x), 1]$ be the linear map sending $f_{i-1}(x) \mapsto b(x)$ and $1 \mapsto 1$. Define $\phi_i: H_i^{-1}g_{i-1}(M) \rightarrow \bar{U}_i \times [-1, 1]$ to be the map sending $(x, t) \mapsto (x, S_x(t))$. Then using

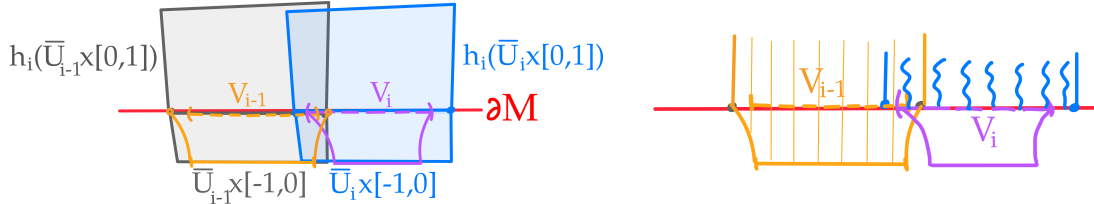

FIGURE 4.4. The local collars and pushing down into the exterior collar.

ϕ_i we can define the map

$$\Phi_i(x): g_{i-1}(M) \rightarrow M^+$$

$$x \mapsto \begin{cases} H_i \phi_i H_i^{-1}(x) & x \in H_i(\overline{U}_i \times [-1, 1]) \\ x & \text{else.} \end{cases}$$

The function H_i^{-1} pulls back into the local collar union the local exterior collar $\overline{U}_i \times [-1, 1]$, then ϕ_i stretches the local collar in \overline{V}_i over all of $\overline{V}_i \times [-1, 0]$, before H_i pushes everything forward into M^+ again. This conjugation method will be used again in the proof of the Schoenflies theorem, and is a powerful way to define global functions that have a desired effect or can be easily defined only in local coordinates.

Then the map

$$g_i := \Phi_i \circ g_{i-1}: M \rightarrow M^+$$

is the required map for the inductive step. One must check that conditions (1) and (3) are satisfied by the above construction. Use (2) to define f_i from g_i . This completes the induction step. Hence $g_m^{-1}(\partial M \times [-1, 0])$ gives us the required collar. \square

In fact we have a relative version of collaring: if one already has a collar on an open subset of ∂M , then the given collar can be extended to a collar on all of ∂M , restricting to the given collar on a specified closed subset of that open set. Collars are also essentially unique, due to Armstrong [Arm70], in the following sense. Given two collars $C_1, C_2: \partial M \times [0, 2] \rightarrow M$, there is an ambient isotopy taking $C_1|_{[0,1]}$ to $C_2|_{[0,1]}$. We will not prove this here.

Remark 4.7. Uniqueness would not hold if we asked for an isotopy between the entire collars. To see this, one needs to know that the Alexander gored ball AGB (the closure of the complement of the Alexander horned sphere embedded in S^3) is (a) not homeomorphic to D^3 , and (b) becomes homeomorphic to D^3 after adding an exterior collar $S^2 \times [0, 1]$ to its boundary the Alexander horned sphere (which is homeomorphic to S^2). So there is a homeomorphism $f: AGB \cup S^2 \times [0, 1] \rightarrow D^3$. If collars were unique without passing first to a subcollar, then there would be an isotopy from $f(S^2 \times [0, 1])$ to the standard collar, which would imply that the complement $D^3 \setminus f(S^2 \times (0, 1])$ is again homeomorphic to D^3 . But this complement is also homeomorphic to the AGB , so we obtain a contradiction.

EXERCISE 4.1. (PS2.3) Let M be an n -dimensional manifold with nonempty boundary. Let U be an open subset of ∂M that is collared, that is there exists an embedding $U \times [0, 1] \hookrightarrow M$ with $(u, 0) \mapsto u$ for all $u \in U$. Let $C \subseteq U$ be a closed subset. Then there exists a collaring of ∂M extending the given collaring on C .

Part II

Topological embeddings

Wild embeddings

Danica Kosanović, Franca Lippert, and Arunima Ray

One of our goals is to give an answer to the following problem.

Question 5.1 (Schoenflies problem). Is every embedding $f: S^{n-1} \hookrightarrow S^n$ equivalent to the equator $S^{n-1} \subseteq S^n$? That is, is there a homeomorphism of pairs $H: (S^n, f(S^{n-1})) \rightarrow (S^n, S^{n-1})$?

In order to get a feeling for this problem, we study some wild embeddings. We will see that some fascinating pathologies can occur.

Recall from Definition 2.2 that an embedding is a continuous injective map which is a homeomorphism onto its image. Also recall that we denote $\mathbb{R}_+^n := \mathbb{R}_+^1 \times \mathbb{R}^{n-1}$. For $m \leq n$ let $\mathbb{R}_+^m \subseteq \mathbb{R}_+^n$ be the product of \mathbb{R}_+^1 with the inclusion $\mathbb{R}^{m-1} \subseteq \mathbb{R}^{n-1}$.

Definition 5.2. Let $e: M^m \hookrightarrow N^n$ be an embedding. We say that e is *locally flat at* $x \in M$ (or at $e(x) \in N$) if there exists a neighbourhood U of $e(x)$ in N and a homeomorphism:

$$\begin{cases} h: U \rightarrow \mathbb{R}^n \text{ such that } h(U \cap e(M)) = \mathbb{R}^m \subseteq \mathbb{R}^n, & \text{if } x \in \text{Int } M, e(x) \in \text{Int } N, \\ h: U \rightarrow \mathbb{R}^n \text{ such that } h(U \cap e(M)) = \mathbb{R}_+^m \subseteq \mathbb{R}^n, & \text{if } x \in \partial M, e(x) \in \text{Int } N, \\ h: U \rightarrow \mathbb{R}_+^n \text{ such that } h(U \cap e(M)) = \mathbb{R}_+^m \subseteq \mathbb{R}_+^n, & \text{if } x \in \partial M, e(x) \in \partial N. \end{cases}$$

We say that e is *locally flat* if it is locally flat at each point; it is *wild at* $x \in M$ if it is not locally flat at x . We say e is *proper* if for each $x \in \text{Int } M$ the first condition holds and for each $x \in \partial M$ the last condition holds.

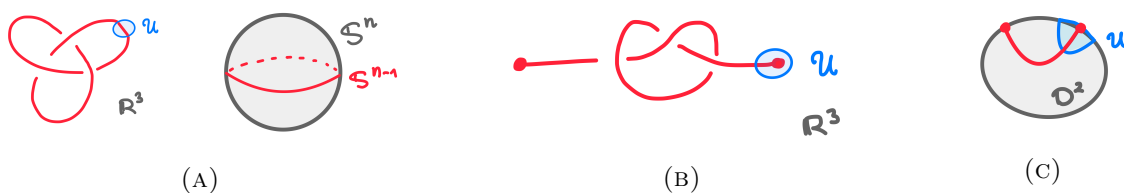
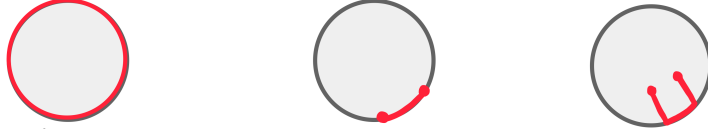

FIGURE 5.1. Examples of locally flat embeddings (in red).

Remark 5.3. With our definition, the boundary of a manifold M is not locally flat in M . More on boundaries in the next section. We will see that the boundary is collared. There is an opposing school of thought that holds that the definition of locally flat ought to be such that a boundary is locally flat, but this is an inconvenient choice for a number of reasons. For example, we will want to understand when locally flat embeddings have normal bundles, or at least well-behaved regular neighbourhoods.

Note that local flatness is preserved under homeomorphism of pairs. We will identify some nice properties of locally flat embeddings, giving us a tool to detect those which are wild.

Definition 5.4. Let $A \subseteq X$ be a closed subset of a topological space.

FIGURE 5.2. Examples of non locally flat embeddings (in red) in D^2 .

- (1) We say that A is k -locally co-connected at $a \in A$, written k -LCC at a , if for every neighbourhood U of a there exists an open neighbourhood V with $a \in V \subseteq U$ such that any $S^k \rightarrow V \setminus A$ extends as

$$\begin{array}{ccc} S^k & \longrightarrow & V \setminus A \\ \downarrow & & \downarrow \\ D^{k+1} & \longrightarrow & U \setminus A \end{array}$$

In other words, $\pi_k(V \setminus A) \rightarrow \pi_k(U \setminus A)$ is trivial for every choice of basepoints for which this makes sense.

- (2) We say that A has a 1-abelian local group at $a \in A$, written 1-alg, if for every neighbourhood U of a there exists an open neighbourhood V with $a \in V \subseteq U$ such that the inclusion induced homomorphism $\pi_1(V \setminus A) \rightarrow \pi_1(U \setminus A)$ has abelian image.
- (3) We say that A is locally homotopically unknotted in X at $a \in A$ if A is both 1-alg and k -LCC at a for every $k \neq 1$.

Remark 5.5. The notion of 1-alg above has some equivalent formulations. We may instead ask that each loop which is null-homologous in $V \setminus A$ is null-homotopic in $U \setminus A$. Alternatively, we may require that the image of $\pi_1(V \setminus A)$ in $\pi_1(U \setminus A)$ is isomorphic to \mathbb{Z} . The interested reader should check that these are indeed equivalent.

Remark 5.6. The use of co-connected should not be confused with the use of this word, in other contexts, to describe vanishing of relative homotopy groups in a range.

Example 5.7. Suppose $M^m \subseteq N^n$ is locally flat. If U is as in the first case of Definition 5.2 we have $(U, M \cap U) \cong (\mathbb{R}^n, \mathbb{R}^m)$, so $U \setminus M \cap U \cong \mathbb{R}^n \setminus \mathbb{R}^m \cong \mathbb{R}^m \times (\mathbb{R}^{n-m} \setminus \{0\}) \simeq S^{n-m-1}$. Therefore,

- If $n - m = 1$, then $\text{Int } M$ is k -LCC for all $k \geq 1$ except $k = 0$.
- If $n - m = 2$, then $\text{Int } M$ is locally homotopically unknotted in N at every point.
- If $n - m > 2$, then $\text{Int } M$ is k -LCC for all $k \leq n - m - 2$.

If U is as in the second case of Definition 5.2, we have

$$U \setminus M \cap U \cong \mathbb{R}^n \setminus \mathbb{R}_+^m \cong (\mathbb{R}^{n-m+1} \setminus \mathbb{R}_+^1) \times \mathbb{R}^{m-1},$$

which is contractible, so ∂M is k -LCC in $\text{Int } M$ for all k in this case. If U is as in the third case of Definition 5.2, we have

$$\begin{aligned} U \setminus M \cap U &\cong (\mathbb{R}_+^1 \times \mathbb{R}^{n-1}) \setminus (\mathbb{R}_+^1 \times \mathbb{R}^{m-1}) \cong \mathbb{R}_+^1 \times (\mathbb{R}^{n-1} \setminus \mathbb{R}^{m-1}) \\ &\cong \mathbb{R}_+^1 \times \mathbb{R}^{m-1} \times (\mathbb{R}^{n-m} \setminus \{0\}) \simeq S^{n-m-1}, \end{aligned}$$

so ∂M is k -LCC in ∂N for all $k \leq n - m - 2$ in this case.

Remark 5.8. The converse in the second case is also true: if $e: M \hookrightarrow N$ is an embedding, $n - m = 2$, and $\text{Int } M$ is locally homotopically unknotted in N at every point, then e is locally flat. This is due to Chapman for dimension ≥ 5 [Cha79] and Quinn for dimension 4 [Qui82a] (see also [FQ90]).

There are converses in the other codimensions as well, such as in [Č73]. Indeed, these may be applied to certain generalisations of manifolds. See [FQ90, Sec. 9.3] and [DV09b, Chap. 7, Chap. 8] for further details.

Remark 5.9. In the topological literature “flat” sometimes means equivalent to the standard embedding, i.e. the only ‘flat’ knot in S^3 is the unknot. In low-dimensional topology ‘flat’ usually means ‘has a trivial normal bundle’, so any smooth knot in S^3 is flat. In the topological terminology, the Schoenflies problem is asking whether any codimension one embedding of a sphere is ‘flat’. We will try to avoid this controversy by just specifying what we mean.

5.1. Fox-Artin arcs and spheres

One could naively ask the following question.

Question 5.10. Are all embeddings locally flat?

The answer is of course no. Let us give an example, due to Artin and Fox [FA48]. We will embed the building block C from Fig. 5.3a into each of the balls D_n for $n \in \mathbb{Z}$, which are the slices of D^3 depicted in Fig. 5.3b.

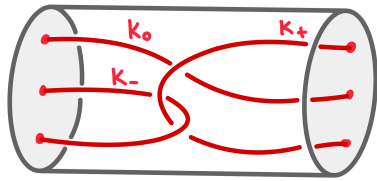

(A) Our building block is the ball $C := D^2 \times [0, 1]$ containing properly embedded arcs $K = K_0 \cup K_- \cup K_+$.

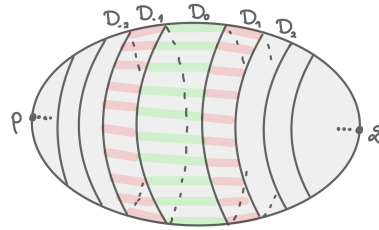

(B) The slices of D^3 .

FIGURE 5.3. Construction of Fox-Artin examples.

The (double) Fox-Artin arc is the image of all arcs K , together with the limiting points:

$$\alpha := \{p\} \cup \bigcup_{n=-\infty}^{n=\infty} f_n(K) \cup \{q\}$$



FIGURE 5.4. Fox-Artin arc α

PROPOSITION 5.11. *The fundamental group $\pi_1(\mathbb{R}^3 \setminus \alpha)$ is non-trivial. Thus, (\mathbb{R}^3, α) is not equivalent to $(\mathbb{R}^3, [0, 1])$.*

Proof. Let us consider the nested sequence subspaces of \mathbb{R}^3 given by

$$X_m := \mathbb{R}^3 \setminus \left(\bigcup_{|n| \geq m} D_n \cup \alpha \right)$$

In other words, as m increases we are “carving out” more and more material from \mathbb{R}^3 . Thus, we want to compute the fundamental group of $X := \mathbb{R}^3 \setminus \alpha = \bigcup_{m \geq 1} X_m$.

The hypothesis of Seifert-van Kampen theorem are satisfied (check), so

$$\pi_1 X \cong \varinjlim \pi_1(X_m),$$

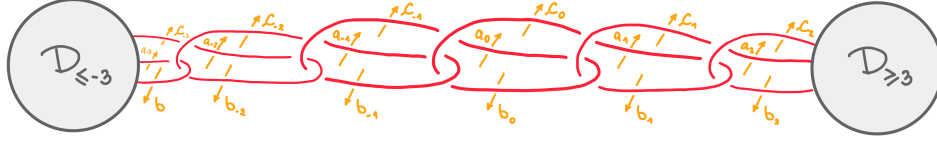

FIGURE 5.5. Proof that the Fox-Artin arc is wild.

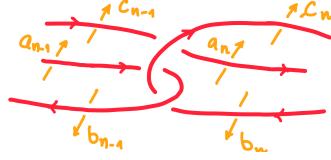

FIGURE 5.6. Proof that the Fox-Artin arc is wild.

the direct limit of the sequence of homomorphisms $\pi_1 X_m \rightarrow \pi_1 X_{m+1}$ induced by inclusions. To compute $\pi_1 X_m$ we see X_m as the complement of (here with $m = 3$):

where we use the standard method to compute the fundamental group of a complement of a graph (cf. Wirtinger presentation of the knot group), using the convention Thus, we obtain

$$\pi_1 X_m = \left\langle \{a_n, b_n, c_n\}_{-m \leq n < m-1} : \begin{cases} a_n c_n = c_n c_{n-1}, \\ b_{n-1} c_n = c_n a_{n-1}, \\ b_{n-1} b_n = c_n b_{n-1} \\ b_{-m}^{-1} a_{-m} c_{-m} = 1, \\ b_{m-1}^{-1} a_{m-1} c_{m-1} = 1 \end{cases} \right\rangle$$

Note that under inclusion map $a_n, b_n, c_n \in \pi_1 X_m$ each map to $a_i, b_i, c_i \in \pi_1 X_{m+1}$.

Therefore, by the definition of direct limit we have

$$\pi_1 X = \left\langle \{a_n, b_n, c_n\}_{n \in \mathbb{Z}} : \begin{cases} a_n c_n = c_n c_{n-1}, \\ b_{n-1} c_n = c_n a_{n-1}, \\ b_{n-1} b_n = c_n b_{n-1}, \\ b_n^{-1} a_n c_n = 1 \end{cases} \text{ for all } n \right\rangle$$

Now eliminating $a_n = c_n c_{n-1} c_n^{-1}$ by the first relation, and $b_n = a_n c_n = c_n c_{n-1} c_n^{-1} c_n = c_n c_{n-1}$ by the last, the two remaining relations both reduce to one:

$$\pi_1 X = \left\langle \{c_n\}_{n \in \mathbb{Z}} : c_{n-1} c_{n-2} c_n c_{n-1} = c_n c_{n-1} c_{n-2} \text{ for all } n \right\rangle$$

We claim that this is a nontrivial group. Indeed, there is a homomorphism $\pi_1 X \rightarrow S_5$ to the symmetric group on five letters, given by $c_n \mapsto \begin{cases} (12345), & n \text{ odd} \\ (14235), & n \text{ even} \end{cases}$ (check that the relation is satisfied). \square

Slightly modifying this example gives another wild arc but for which the argument using the fundamental group will not work. Namely, we use the same building block from Fig. 5.3a but now put it into the slices only of one half of the ball, see Fig. 5.7.

The resulting Fox-Artin arc $\beta := \bigcup_{n \geq 0} f_n(K) \cup \{q\}$ is shown in Fig. 5.8. This has a simply connected complement $\pi_1(\mathbb{R}^3 \setminus \beta) \cong 1$. Indeed, the computation is similar as in the previous proof but now the loop c_n is trivial. Actually, $\mathbb{R}^3 \setminus \beta \cong \mathbb{R}^3 \setminus \{pt\}$ (see [FA48]). However, we show that β is nevertheless wild.

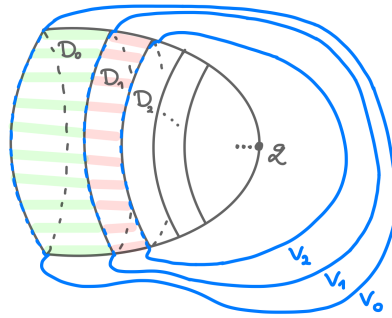

FIGURE 5.7. The model half-ball for the arc β together with the open sets V_n (in blue) from the proof of Proposition 5.12.

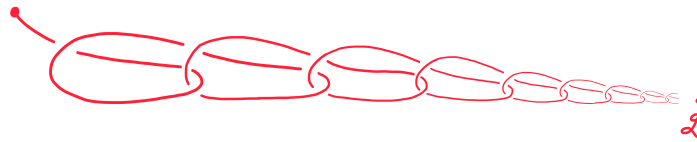

FIGURE 5.8. Fox-Artin arc β .

PROPOSITION 5.12. β is not 1-LCC at q . Therefore, β is a wild embedding.

Proof. Let V_n be open sets as in Fig. 5.7. If β was 1-LCC at q , then there would exist $N \geq 0$ such that $\pi_1(V_N \setminus \beta) \rightarrow \pi_1(V_0 \setminus \beta)$ is trivial (since by definition of 1-LCC can find $V \subseteq V_0$, but then can find $V_N \subseteq V$ for some N).

Now $\pi_1(V_N \setminus \beta)$ is generated by c_N, c_{N-1}, \dots subject to $c_{n-1}c_{n-2} = c_n c_{n-1}$ for $n \geq N + 1$ and $c_n c_{n-1} c_{n-2} = 1$, and each c_n maps to $c_n \in \pi_1(V_0 \setminus \beta)$ under the homomorphism induced by the inclusion. However, each c_n is nontrivial in $\pi_1(V_0 \setminus \beta)$, which we can see using the same homomorphism to S_5 as in previous proof. \square

5.1.1. Wild spheres. The examples so far have concerned arcs in \mathbb{R}^3 , or equivalently in S^3 if we pass to the 1-point compactification, while our original question had been in terms of embedded spheres. Such examples can also be generated from our arcs. For example, by taking two parallel copies of each strand in the building block for the Fox-Artin arc, we can produce (double and single) Fox-Artin 1-spheres, see Fig. 5.9.

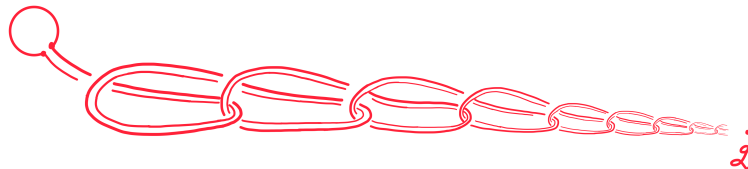

FIGURE 5.9. Fox-Artin 1-sphere.

Alternatively, by replacing each strand in the building block by a tube, we produce (double and single) Fox-Artin 2-spheres, see Fig. 5.10. Similar proofs as above show that these are not locally flat. A more well-known example of a non-locally flat S^2 in S^3 is the *Alexander horned sphere*, which we describe in the next section. The set of wild points of the Alexander horned sphere form a Cantor set. We will soon also describe *Bing's hooked rug*, another embedded S^2 in \mathbb{R}^3 , where every point is wild.

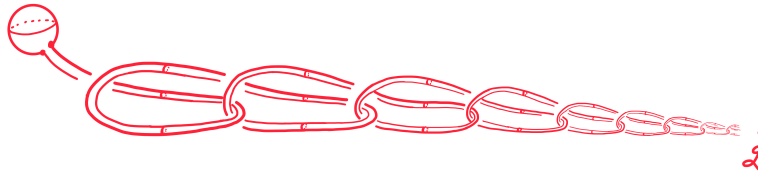

FIGURE 5.10. Fox-Artin 2-sphere.

In terms of Question 5.1, which asks whether every embedding $S^{n-1} \hookrightarrow S^n$ is equivalent to the standard one (the equator), we see now that we must restrict to locally flat embeddings. We will see later what the exact conditions will be, see Chapter 6.

5.2. The Alexander horned sphere

The Fox-Artin 2-sphere has precisely one wild point. In this section, we construct the Alexander horned sphere, an embedded S^2 in \mathbb{R}^3 , whose wild points form a Cantor set, i.e. there are embeddings $C \hookrightarrow [0, 1] \hookrightarrow S^2 \hookrightarrow \mathbb{R}^3$, such that the image of the last embedding is the Alexander horned sphere, C is a Cantor set and the image of C under the composition of the three embeddings is exactly the set of wild points in the Alexander horned sphere.

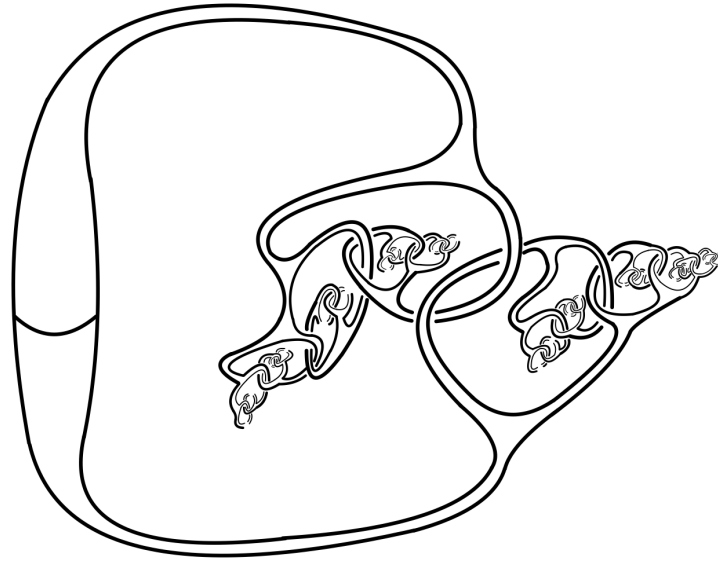

FIGURE 5.11. The Alexander horned sphere

Before starting the construction of the Alexander horned sphere, we need the following definition.

Definition 5.13 (Pillbox [DV09a]). A *pillbox* is a copy C of $D^2 \times [0, 1]$ containing linked solid tori T_1 and T_2 as shown in Figure 5.12 such that $T_1 \cap \partial C = \tau$ and $T_2 \cap \partial C = \beta$, where we call $D^1 \times \{1\}$ the top disc τ and $D^2 \times \{0\}$ the bottom disc β .

A pillbox is shown in Figure 5.12.

5.2.1. Construction. We begin with a solid ball B_0 and attach a handle $D^2 \times [0, 1]$ along $D^2 \times (\{0\} \cup \{1\})$. The result is a solid torus X_0 . Now we remove a pillbox from X_0 , i.e. we remove a cylindrical 3-cell (containing two linked tori) and call the resulting manifold B_1 . A picture of B_1 is shown in Figure 5.13 and one can see that it is homeomorphic to a solid ball, so

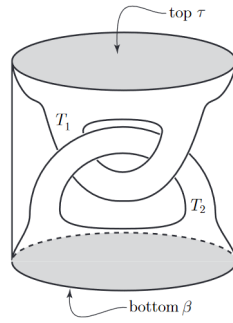

FIGURE 5.12. A pillbox. This picture is from [DV09a, p. 48].

in particular $B_1 \cong B_0$. To B_1 we now add the linked solid tori T_1 and T_2 which we removed earlier and call the result X_1 (Figure 5.13).

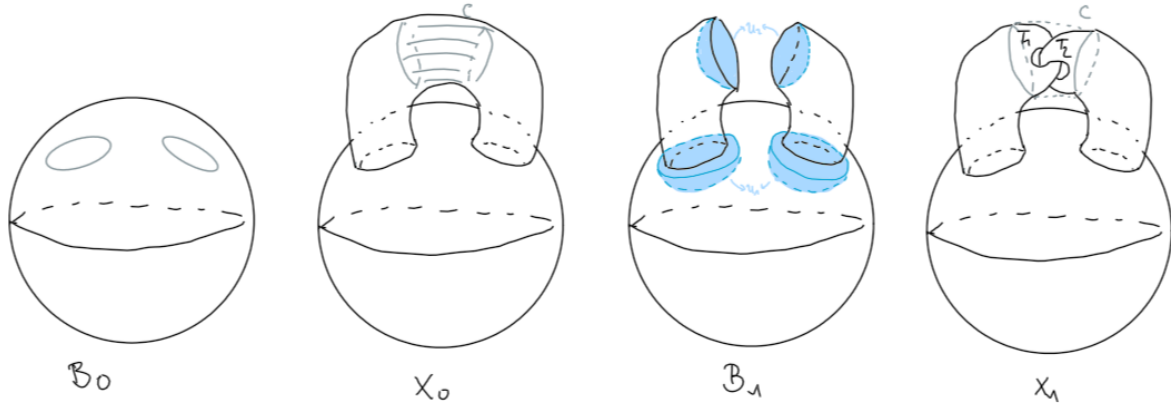

FIGURE 5.13. The step B_0 to X_1 . Note that every space is solid here. The neighborhoods U_1 and U_2 are indicated in blue.

In the next step we remove a pillbox from each of the solid tori T_1 and T_2 to get a manifold $B_2 \cong B_1 \cong B_0$. Then we replace the pillboxes by the solid tori inside and call the resulting manifold X_2 . We continue inductively. So in step n we remove 2^{n-1} pillboxes from X_{n-1} and call the result B_n . Then we attach 2^n linked solid tori and call the resulting manifold X_n .

One can summarize that X_n arises from X_{n-1} by removing something, namely the complement of the linked solid tori in 2^{n-1} disjoint pillboxes.

$$\begin{array}{ccccc}
 X_{n-1} & \xrightarrow{\text{remove } 2^{n-1} \text{ pillboxes}} & B_n & \xrightarrow{\text{attach } 2^n \text{ solid tori}} & X_n \\
 & \searrow & & \nearrow & \\
 & & \text{remove } C \setminus (T_1 \cup T_2) \text{ } 2^{n-1} \text{ times} & &
 \end{array}$$

In contrast to this, we attach 2^n horns to obtain B_n from B_{n-1} , coming from 2^{n-1} attached solid tori with pillboxes removed. These attached horns are the reason for the name of the Alexander horned sphere.

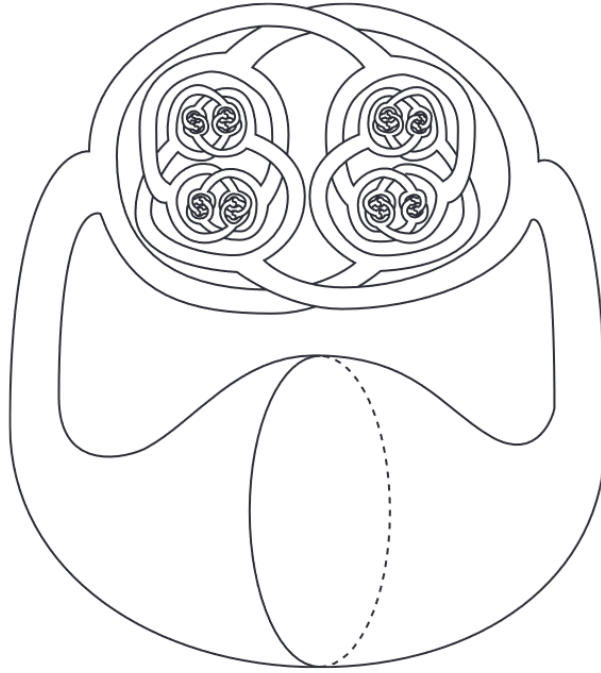

FIGURE 5.14. The Alexander horned sphere. Picture from [DV09a, p.50]

$$\begin{array}{ccc}
 B_{n-1} & \xrightarrow{\text{attach } 2^{n-1} \text{ tori}} & X_{n-1} \xrightarrow{\text{remove } 2^{n-1} \text{ pillboxes}} B_n \\
 & \searrow \text{attach } 2^n \text{ horns} & \nearrow
 \end{array}$$

So in the end we constructed a nested sequence $B_0 \subseteq B_1 \subseteq B_2 \subseteq \dots$ of solid balls as well as a nested sequence $X_0 \supseteq X_1 \supseteq X_2 \supseteq \dots$ of 3-manifolds with boundary. We can now define the *Alexander horned ball* to be

$$B := \bigcap_{i=0}^{\infty} X_i.$$

We define the *Alexander horned sphere* $A := \partial B$. Here we just mean the topological boundary since we do not know yet that B is a manifold. But in the next paragraph we will prove that B is homeomorphic to D^3 and that A is therefore homeomorphic to a sphere.

The Alexander horned sphere is depicted in Figures 5.11, 5.14 and 5.15. The Alexander gored ball is the complement of the Alexander horned ball. This space has nontrivial perfect fundamental group. It is therefore not homeomorphic to a ball. It shows that the Schoenflies theorem does not hold without the locally flat hypothesis. See also Remark 4.7.

5.2.2. The Alexander horned sphere is a sphere. To show that the Alexander horned sphere is indeed a sphere, we first remark that $B = \overline{\bigcup_{i=0}^{\infty} B_i}$, which holds by construction. Now note that there are homeomorphisms $h_i: B_{i-1} \rightarrow B_i$ that restrict to the identity on a neighbourhood of the bases of the attached horns because we can contract the horns homeomorphically into neighbourhoods of their base. In particular, for every index n there is a neighborhood U_n of $B_n \setminus B_{n-1} \subseteq B_n$ as indicated in Figure 5.13 such that $h_k|_{U_n}$ is the identity on $U_n \subset B_k \setminus B_{k-1}$ for any $k \geq n$. Define $f_n: B_0 \rightarrow B_n$ to be the composition $f_n = h_n \circ \dots \circ h_1$. The map f_1 equals h_1 and moves nothing outside the horns and U_1 . The map f_2 differs from f_1 just on U_2 . We can say that the horns get smaller in each step if we consider the Alexander horned sphere as subset of \mathbb{R}^3 with its standard metric. So we can choose the neighborhoods U_k so that they get smaller

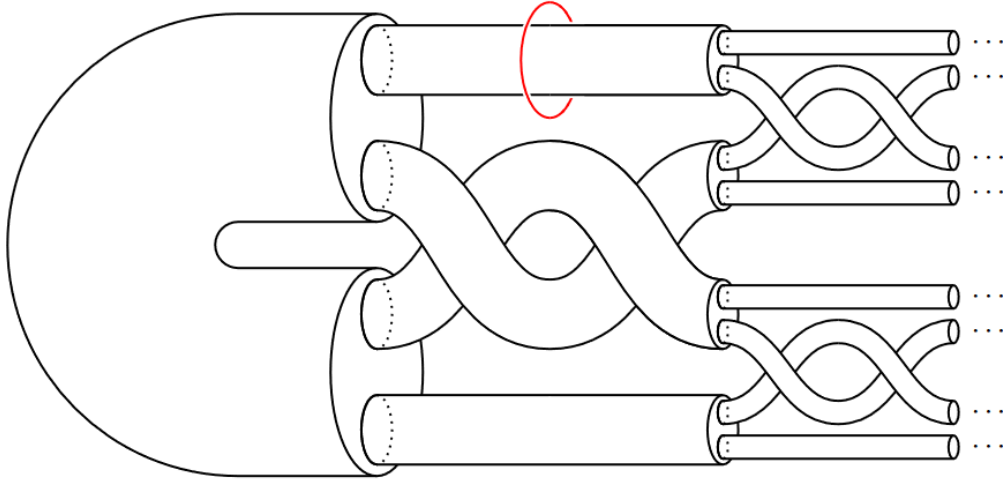

FIGURE 5.15. Another picture of the Alexander horned sphere. The length of the tubes needs to decrease to zero so that the limit points are reached. Picture from [BKK⁺21, p.72]

and therefore the map f_n differs from f_{n-1} on a very small neighborhood for larger n . Thus, the maps $\{f_n\}$ converge uniformly to a continuous map $f: B_0 \rightarrow B$. We want to show that f is bijective.

Define $C := f^{-1}(B \setminus \bigcup_{i=0}^{\infty} B_i) \subseteq B_0$. So C is the preimage of the set of points that form the limit of the tubes in Figure 5.15. A point in $f(C)$ is uniquely determined by the sequence of choices one would make when choosing a path starting at a point in the left half of a torus in Figure 5.15 and ending at the point in $f(C)$. Whenever we are in an area of the Alexander horned sphere where two horns are attached we have to decide whether to go along the upper horn or along the lower horn. Two different horns will never lead to the same limit point since two horns are never glued to each other. So $f(C)$ forms a Cantor set.

For a point $x \in B_0 \setminus C$ there is an index N such that $x \in U_N$, so $f|_{U_N} = f_N|_{U_N}$, hence f is bijective on $B_0 \setminus C$. We will now show injectivity and surjectivity of $f|_C$. Consider Figure 5.15. Any two points in C will be separated by horns, that is there exists n such that $f_n(x)$ and $f_n(y)$ lie in different horns, so that they cannot have the same image under f . This implies that $f|_C$ is injective. Each point of $B \setminus \bigcup_{i=0}^{\infty} B_i$ lies in the image of f since there is a (unique) sequence that encodes the horns leading to that point and so this point is part of the Cantor set $f(C)$. So $f|_C$ is also surjective.

Now, f is a continuous and bijective map from a compact space to a Hausdorff space and is therefore a homeomorphism. Since $B_0 \cong D^3$ by definition, the Alexander horned ball is indeed a ball, which implies that the Alexander horned sphere is a sphere.

5.2.3. Wildness of the Alexander horned sphere. We will prove with the help of Lemma 5.14 below that the fundamental group of the complement of the Alexander horned sphere is not trivial. It will follow by the Schoenflies theorem then, that the embedding $A \hookrightarrow \mathbb{R}^3$ cannot be locally flat.

LEMMA 5.14. ([DV09a, lemma 2.1.9]) *Let C be a pillbox and Y be a closed subset of \mathbb{R}^3 such that $Y \cap C = \tau \cup \beta$, and let J be a 1-sphere in $\mathbb{R}^3 \setminus (Y \cup C)$ as shown in Figure 5.16. If $\pi_1(J) \rightarrow \pi_1(\mathbb{R}^3 \setminus (Y \cup C))$ is injective, then $\pi_1(\mathbb{R}^3 \setminus (Y \cup T_1 \cup T_2)) \rightarrow \pi_1(\mathbb{R}^3 \setminus (Y \cup T_1 \cup T_2))$ is also injective.*

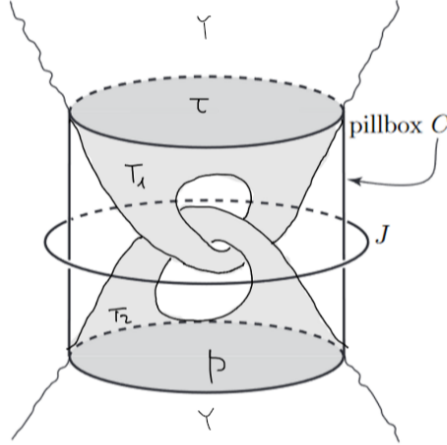

FIGURE 5.16. Parts of this picture are from [DV09a].

Proof. The proof follows Bing's paper [Bin61]. Assume, that $\pi_1(J) \rightarrow \pi_1(\mathbb{R}^3 \setminus (Y \cup C))$ is injective, so J is not null-homotopic in $\mathbb{R}^3 \setminus (Y \cup C)$. We now consider a loop $K \subseteq \mathbb{R}^3 \setminus (Y \cup C)$ that is null-homotopic in $\mathbb{R}^3 \setminus (Y \cup T_1 \cup T_2)$ and show that it is also null-homotopic in $\mathbb{R}^3 \setminus (Y \cup C)$.

Since K is null-homotopic in $\mathbb{R}^3 \setminus (Y \cup T_1 \cup T_2)$, there is a map $f: D^2 \rightarrow \mathbb{R}^3 \setminus (Y \cup T_1 \cup T_2)$ that maps ∂D^2 homeomorphically onto K . We will now consider the preimage of ∂C under f . If it is empty, then $f(D^2)$ lies entirely inside $\mathbb{R}^3 \setminus (Y \cup C)$, so K would be null-homotopic in $\mathbb{R}^3 \setminus (Y \cup C)$ and we are done. So we consider the case where $f^{-1}(\partial C)$ is non-empty. By transversality, $f^{-1}(\partial C)$ is a finite union of closed submanifolds of dimension 1, so it is a finite union of embedded $S^1 \hookrightarrow D^2$. We will now use the so-called "innermost disc argument" to adjust f so that the preimage of ∂C under this new f is non-empty.

Among all the embedded S^1 s in the preimage of ∂C under f , there will be at least one, call it \mathcal{L}_1 , that bounds an innermost disc. That is, it bounds a disc $\text{Int } D_1$ such that $f(\text{Int } D_1) \cap \partial C$ is empty.

CLAIM. $f(D_1)$ can be shrunk to a point on $\partial C \setminus (\tau \cup \beta)$.

Assume, that the claim holds. Then we can shrink $f(D_1)$ to a point and push this point slightly away from ∂C into $\mathbb{R}^3 \setminus (Y \cup C)$. Like this, we got rid of one innermost disc. Since we just have finitely many closed curves in the preimage of ∂C , we can repeat this process until there are no curves in $f^{-1}(\partial C)$ anymore, and we are done.

Proof of Claim. We have to check two cases, namely the case that $\text{Int } D_1 \subseteq \text{Int } C$ and the case that $D_1 \cap \text{Int } C = \emptyset$.

Case 1: $D_1 \subseteq \text{Int } C$.

Define $M_1 := C \setminus (T_1 \cup T_2)$. This is a manifold with boundary. Note that T_1 and T_2 are closed, so that the manifold boundary of M_1 is exactly $\partial C \setminus (\tau \cup \beta)$ which is homeomorphic to $S^1 \times (0, 1)$.

We compute $\pi_1(M_1)$. It is equivalent to the fundamental group of the complement of the finite graph G shown in Figure 5.17.

We can easily compute the Wirtinger presentation of $\pi_1(\mathbb{R}^3 \setminus G)$ and see that

$$\pi_1(\mathbb{R}^3 \setminus G) = \langle a, b, c, d, e \mid a = ec, cb = dc, ab = bc, b = ed \rangle \cong \langle a, b \rangle \quad \text{where } e = ab^{-1}a^{-1}b \neq 1.$$

It is the free group on two generators and a loop corresponding to e is not trivial in $\pi_1(M_1)$. This latter loop L is given by one that circles $\partial M_1 \cong S^1 \times (0, 1)$ once. So it corresponds to the generator of $\pi_1(\partial M_1) \cong \mathbb{Z}$. In particular, any loop circling ∂M_1 k times for $0 \neq k \in \mathbb{Z}$ is not null-homotopic since it corresponds to the element $k \cdot e \in \pi_1(M_1)$ which is not trivial.

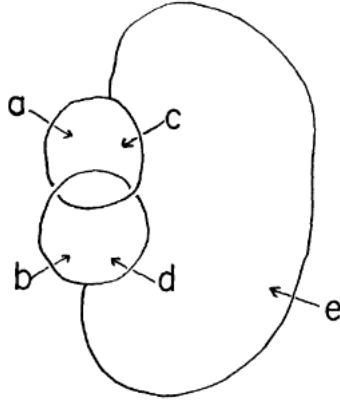

FIGURE 5.17. A finite graph with $\pi_1(\mathbb{R}^3 \setminus G) \cong \pi_1(M_1)$. Picture from [Bin61].

We conclude that any loop α on the boundary of M_1 that is null-homotopic in M_1 is already null-homotopic on the boundary of M_1 .

Since \mathcal{L}_1 bounds a disc inside C , it is null-homotopic inside M_1 and therefore also on $\partial M_1 = \partial C \setminus \tau \cup \beta$ which is what we had to show.

Case 2: $f(\text{Int } D_1) \cap \text{Int } C = \emptyset$.

Define $M_2 := \mathbb{R}^3 \setminus (Y \cup \text{Int } C)$. It is a 3-dimensional manifold with boundary. Since we remove Y entirely and keep the boundary of C , its manifold boundary is given by $\partial M_2 = \partial C \setminus \tau \cup \beta \cong S^1 \times (0, 1)$.

We apply the loop theorem to M_2 : if there exists a closed curve γ on ∂M_2 such that $\gamma \simeq *$ in M_2 but $\gamma \not\simeq *$ on ∂M_2 , then there exists a simple closed curve with the same property.

The loop $f(\mathcal{L}_1)$ is a simple closed curve on ∂M_2 that bounds a disc in M_2 . If $f(\mathcal{L}_1)$ could not be shrunk to a point on ∂M_2 , then by the loop theorem there is a simple closed curve with the same property. A simple closed curve is an embedded S^1 . We will now consider simple closed curves on ∂M_2 . Any simple closed curve γ on ∂M_2 such that $\gamma \not\simeq *$ on ∂M_2 is homotopic to L which was the loop corresponding to the generator of $\pi_1(M_1) = \pi_1(\partial C \setminus (\tau \cup \beta)) = \pi_1(M_2)$. If $L \simeq *$ in M_2 , then $\pi_1(\partial M_2)$ would be trivial in $\pi_1(M_2)$. This means, $\pi_1(J)$ would be trivial in $\pi_1(\mathbb{R}^3 \setminus (Y \cup C))$ which is not the case by assumption. We conclude that any loop on ∂M_2 that is not null-homotopic in M_2 is already null-homotopic on ∂M_2 and can finish the proof with the same argument as in Case 1. \square

The proof of the claim finishes the proof of Lemma 5.14. \square

Now if we find an essential loop in $\mathbb{R}^3 \setminus X_0$, Lemma 5.14 tells us that the loop will also be essential in $\mathbb{R}^3 \setminus X_n$ for every $n \geq 0$. The complements of the X_n form a nested sequence of open sets $\mathbb{R}^3 \setminus X_0 \subseteq \mathbb{R}^3 \setminus X_1 \subseteq \dots$. Consider any null-homotopic loop in $\mathbb{R}^3 \setminus A$. The image of the homotopy that contracts the loop to a point is compact in $\mathbb{R}^3 \setminus A$ and lies therefore already in $\mathbb{R}^3 \setminus X_n$ for some n . Thus, the loop is already null-homotopic in the complement of some X_n . We conclude that every essential loop in $\mathbb{R}^3 \setminus X_n$ for some n is also essential in $\mathbb{R}^3 \setminus A$. So we can derive from lemma Lemma 5.14 that $\pi_1(\mathbb{R}^3 \setminus A)$ is not trivial since J is one example of an essential loop in X_0 if we choose Y to be $X_0 \setminus C$. By the Schoenflies theorem, the embedding is therefore not locally flat, hence wild.

Remark 5.15. We have already seen an embedding of a Cantor set into the sphere and know that the Alexander horned sphere is locally flat outside the image of the embedded Cantor set. But we did not see why this Cantor set is exactly the set of wild points. One way to think about this is to consider neighborhoods U_x of any point x in the embedded Cantor set on the

Alexander horned sphere. Such a point lies in the intersection of an infinite sequence of solid tori $(T_k)_{1 \leq k \in \mathbb{Z}}$ lying inside pillboxes $P_k \supseteq T_k$ and U_x contains a part of this sequence, say $(T_k)_{k \geq l}$ for some $l \geq 1$. We find for any n a neighborhood V_x of x that looks exactly the same as U_x such that V_x just contains $(T_k)_{k \geq n+l}$. But if $\pi_1(\mathbb{R}^3 \setminus U_x)$ is not trivial then $\pi_1(\mathbb{R}^3 \setminus V_x)$ cannot be trivial as well. Since we can choose U_x to be A itself, we can find for every neighborhood V of x a neighborhood $V_x \subseteq V$ such that $\pi_1(\mathbb{R}^3 \setminus V_x)$ is not trivial. Therefore there is not neighborhood W of x such that $W \setminus A$ is homeomorphic to $\mathbb{R}^3 \setminus \mathbb{R}^2$ which implies that x is not embedded in a locally flat way. More details on this can be found in [Hat02a].

5.3. Bing's hooked rug

As already mentioned above, the set of wild points of the Alexander horned sphere A is a Cantor set in the sense that there is an embedding of a Cantor set $C \hookrightarrow A$ such that the image of C is exactly the set of wild points of A . We now construct an example of an embedded 2-sphere in \mathbb{R}^3 such that the embedding is wild at every point of the sphere. This sphere was originally constructed by R.H. Bing in [Bin61] in order to give an counterexample to the conjecture that an embedding $S^2 \hookrightarrow \mathbb{R}^3$ is locally flat if each arc in the image of the sphere is locally flat. However, we will not prove that each arc in Bing's hooked rug is tame since we would have to develop some tools that would go beyond the scope of this chapter. But we will see that Bing's hooked rug is somehow a 'very' wild sphere, in the sense that it is wild at every point.

For the construction of Bing's hooked rug we need the definition of an *eyebolt*.

Definition 5.16 (Eyebolt [DV09a]). An *eyebolt* is the union of a tube with a solid torus. A *plug* for the eyebolt is a copy of $D^2 \times (0, 1)$ embedded into the solid torus part of the eyebolt.

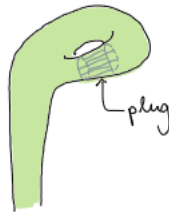

FIGURE 5.18. A plug and an eyebolt.

Now we can start the construction.

5.3.1. Construction. We start with the standard solid ball F_0 in \mathbb{R}^3 .

Step 1. In the first step of the construction, we cover F_0 with discs E_1, \dots, E_n where $n > 0$ is an integer of our choice. The discs should satisfy the following two properties:

- (1) $\text{Int } E_i \cap \text{Int } E_j = \emptyset$ for any $i \neq j$,
- (2) the discs are arranged in a circular pattern, i.e. $E_i \cap E_{i+1}$ is an arc in the boundary of each for $i \leq n - 1$. The same holds for $E_n \cap E_1$.

We attach an eyebolt g_i on each of the discs E_i and "hook" g_i to the base of g_{i+1} (and g_n to the base of g_1), as indicated in Figure 5.19. We shrink the resulting 3-manifold slightly such that it lies inside F_0 and call it H_1 . Now, we remove a plug from each of the eyebolts to get a manifold F_1 that is homeomorphic to a solid ball, so $F_1 \cong F_0$.

Step 2. Now, we cover F_1 with closed discs E'_1, \dots, E'_n that have the same boundaries as the image of E_1, \dots, E_n under a homeomorphism $F_0 \cong F_1$. Afterwards, we cover each E'_i with discs E''_1, \dots, E''_k for a number $k \geq 2$ that we can freely choose, that satisfy properties 1 and 2. Now, we attach an eyebolt g''_j to each E''_j and hook g''_j to the base of g''_{j+1} for $j \leq n - 1$, and g''_n to the base of g''_1 . After shrinking the result slightly, we again obtain a 3-manifold with boundary which

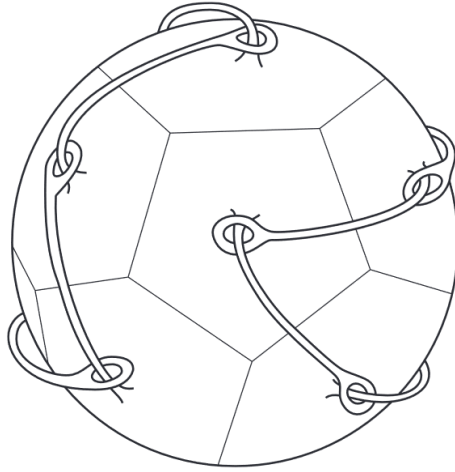

FIGURE 5.19. The first stage H_1 of the construction of Bing's hooked rug. This picture is from [DV09a].

we call $H_2 \subseteq H_1$. We remove a plug from each eyebolt on H_2 and call the resulting manifold $F_2 \cong F_1 \cong F_0$. Parts of H_2 are shown in Figure 5.20.

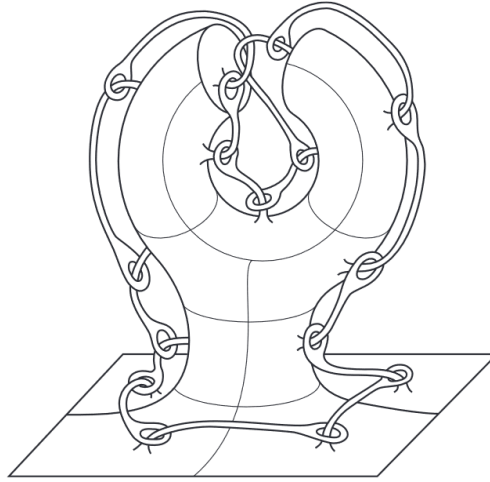

FIGURE 5.20. Parts of the manifold H_2 . The picture is from [DV09a].

We continue inductively. Here is an instruction for step k , that shows how we obtain H_k and F_k from F_{k-1} .

Step k . F_{k-1} is covered with discs E_1, \dots, E_n where on each disc there is an eyebolt with a plug removed and which is not covered by the E_i . Here we take the same notation for the cover as in earlier steps since another naming would be complicated and the name of the discs will not be very important later. Cover F_{k-1} with discs E'_1, \dots, E'_n , that have the same boundaries as E_1, \dots, E_n and cover each of these discs with n discs that satisfy properties 1 and 2. Attach an eyebolt to each disc and hook it to the base of the eyebolt on the next disc. Shrink the result and call it H_k . Now remove a plug from each eyebolt and call the resulting space F_k . It is homeomorphic to F_i for any $i \leq k$.

We constructed a nested sequence of 3-manifolds with boundary $H_1 \supseteq H_2 \supseteq \dots$ and we define

$$H := \bigcap_{i=1}^{\infty} H_i.$$

Bing's hooked rug is now defined as ∂H .

As for the Alexander horned sphere, our aim is now to prove that Bing's hooked rug is indeed homeomorphic to a sphere as well as that it is wildly embedded into \mathbb{R}^3 . This will be proven in the following two sections.

5.3.2. Bing's hooked rug is an embedded sphere. As already mentioned, there are homeomorphisms $h_i: F_{i-1} \rightarrow F_i$ that can be controlled in their size by the number and size of the covering discs. This is the reason why we can choose the discs and the sequence $(f_n)_{n \in \mathbb{N}}$ such that it converges uniformly, where $f_n := h_n \circ \dots \circ h_1$. Thus the limit map $f: F_0 \rightarrow H$ will be continuous. Again, we just have to show bijectivity of f to conclude that f is a homeomorphism.

For the proof of bijectivity of f we can choose the shrinking applied in each step to be the radial shrinking which is a homeomorphism. Therefore we will drop this step from now on. In step k of the construction we subdivide the covering of F_{k-1} such that the union of all boundaries of the old discs form a subset of the union of the boundaries of all discs in the subdivision. From F_{k-1} to F_k we do not change anything on the boundary of the discs E_i so we can choose h_k such that it fixes the boundaries of the discs on F_{k-1} .

Two disjoint discs of the covering of F_n will be disjoint under f since we do not change their boundary and the discs have disjoint interiors by construction. For two different points $x, y \in F_0$ there will be an index k such that $f_k(x)$ and $f_k(y)$ lie on different discs of the covering of F_k . So $f(x)$ and $f(y)$ will be distinct points and we can conclude that f is injective.

We have proved that f is a continuous and bijective map from a compact space to a Hausdorff space. By the compact Hausdorff lemma $f: F_0 \rightarrow H$ is a homeomorphism which shows that H is homeomorphic to a solid ball. Thus $B = \partial H$ is homeomorphic to a sphere.

5.3.3. Wildness of Bing's hooked rug. We will prove that the embedding $B \hookrightarrow \mathbb{R}^3$ is wild at every point by showing that it is not 1-LCC at every point of the embedding.

Recall that a co-dimension one embedding $A \hookrightarrow X$ that is locally flat at a point $a \in A$ is k -LCC for $k \geq 1$ at that point (Example 5.7).

We will prove a similar lemma to Lemma 5.14 and can conclude from it that the embedding is not 1-LCC at every point by finding an index i and an essential loop in $\mathbb{R}^3 \setminus H_i$ circling the base of an eyebolt in H_i and proving that it is essential in $\mathbb{R}^3 \setminus H_k$ for any $k \geq i$. By construction, the eyebolts will be spread densely over B in the end, so we can find such a loop in every neighborhood of a point.

LEMMA 5.17. *Let C be a 3-cell in \mathbb{R}^3 and let B_1, B_2 and B_3 be three disjoint discs on ∂C . Let T be a solid torus in C such that $T \cap \partial C = B_1$ and let S be a 3-cell in C such that $S \cap \partial C = B_1 \cup B_2$. Assume T and S are linked as indicated in Figure 5.21. Let Y be a closed subset of \mathbb{R}^3 such that $Y \cap C = B_1 \cup B_2 \cup B_3$.*

If $\pi_1(\partial C \setminus (B_1 \cup B_2 \cup B_3)) \rightarrow \pi_1(\mathbb{R}^3 \setminus (Y \cup \text{Int } C))$ is injective, then $\pi_1(\mathbb{R}^3 \setminus (Y \cup C)) \rightarrow \pi_1(\mathbb{R}^3 \setminus (Y \cup S \cup T))$ is injective.

Proof. The proof of this lemma is similar to the proof of Lemma 5.14. Assume, $\pi_1(\partial C \setminus (B_1 \cup B_2 \cup B_3)) \rightarrow \pi_1(\mathbb{R}^3 \setminus (Y \cup \text{Int } C))$ is injective. Now choose a loop $J \subseteq \mathbb{R}^3 \setminus (Y \cup S \cup T)$ that is null-homotopic, i.e. that bounds a disc. We have a map $f: D^2 \rightarrow \mathbb{R}^3 \setminus (Y \cup S \cup T)$ such that $f(\partial D^2) \cong J$. We consider again $f^{-1}(\partial C)$ and use transversality to see that it is a finite union of simple closed curves. We choose an innermost disc bounded by \mathcal{L}_1 and will prove now that \mathcal{L}_1 is nullhomotopic on $\partial C \setminus (B_1 \cup B_2 \cup B_3)$. Again, we have to consider the two cases where the disc bounded by \mathcal{L}_1 lies inside or outside C .

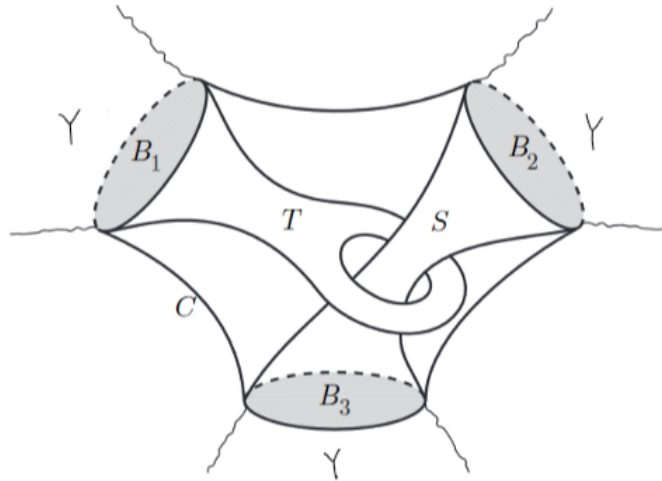

FIGURE 5.21. The situation of Lemma 5.17. Picture from [DV09a, p.88]

Case 1: Define M_1 to be $C \setminus (T \cup S)$. It is a 3-dimensional manifold with boundary $\partial M_1 = \partial C \setminus (B_1 \cup B_2 \cup B_3)$. We compute $\pi_1(M_1)$ which is a free group of two generators. Note that the boundary of any of the three discs B_i is not null-homotopic in ∂M_1 and that the three boundaries of the discs even generate the fundamental group of ∂M_1 . Now assume there is a closed curve γ on ∂M_1 such that γ is null-homotopic in M_1 but not on ∂M_1 . By the loop theorem, there is a simple closed curve with the same property. This could, up to homotopy, only be ∂B_i for some $i = 1, 2, 3$. But ∂B_i is not null-homotopic in M_1 . So there is no such closed curve $\gamma \subseteq \partial M_1$. Thus, any loop on ∂M_1 that is null-homotopic in M_1 is null-homotopic on ∂M_1 . In particular, \mathcal{L}_1 is null-homotopic on ∂M_1 . Thus in this case, \mathcal{L}_1 is null-homotopic on ∂M_1 as we wanted to show.

Case 2: Define $M_2 := \mathbb{R}^3 \setminus (Y \cup \text{Int } C)$. It is a 3-manifold with boundary $\partial M_2 = \partial C \setminus (B_1 \cup B_2 \cup B_3)$. By using the loop theorem, we see that every loop on ∂M_2 that is null-homotopic in M_2 is also null-homotopic on ∂M_2 since $\pi_1(\partial M_2)$ is generated by the boundaries of the three discs that are not null-homotopic in M_2 . Thus \mathcal{L}_1 is null-homotopic on ∂M_2 .

As in Lemma 5.14 we can now conclude the statement of this lemma. \square

To apply the lemma, we will consider the step $H_{i-1} \rightarrow H_i$ in the construction of Bing's hooked rug again in more detail. In Figure 5.22 the step is divided into several substeps that we explain next.

We start in H_{i-1} on the top left. After removing the complement of two linked solid tori inside a pillbox, we constructed H'_i . Now, to get to H''_i , we need two substeps. First, we attach a handle to each of the discs in the subdivision (\tilde{H}_i). Then, we move one base of each handle including the first two handles on H'_i onto the disc with the next higher index (\tilde{H}'_i). So everything is moved in a circular pattern around the surface. To obtain H''_i , we move the base of a handle, that is now on the disc with higher index, onto the other handle that has a base on the same disc and thicken up the moved base of the handle. Like this, we get such tubes on each disc, that have a bulb at the end where the next tube goes through. Since everything is solid, these intersections do not disturb the manifold property of H''_i . From H''_i to H_i we cut a hole into the bulbs where the tubes can go through and see that we have constructed hooked eyebolts.

Now we can see what happens to an essential loop in the complement of H_i after passing to H_{i+1} . The loop K shown in Figure 5.22 is essential in $\mathbb{R}^3 \setminus H''_i$ since it circles an attached handle. Lemma 5.17 implies that K will also be essential in $\mathbb{R}^3 \setminus H_i$. Now we can see that by Lemma 5.14, K is essential in the complement of H'_{i+1} . From H'_{i+1} to H''_{i+1} we just add some

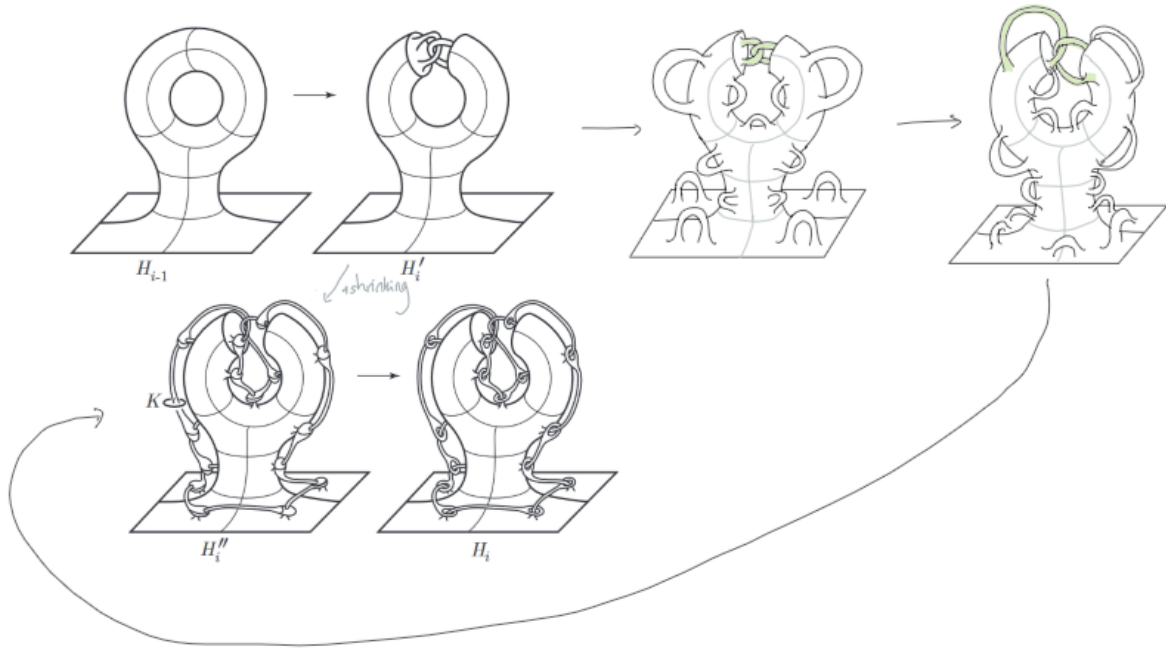

FIGURE 5.22. The construction step $H_{i-1} \rightarrow H_i$ in more detail. Parts of the picture are from [DV09a]. Note that what is shown here is always just a part of H_i or H_{i-1} .

handles that can not trivialize essential loops. So K is essential in $\mathbb{R}^3 \setminus H''_{i+1}$. We continue again inductively. As mentioned above, for any neighbourhood $U \subseteq B$ of a point $x \in B$ we will always find N , such that one of the discs E_i covering F_N in stage N lies entirely in U . Therefore, for any neighbourhood U we will find an essential loop in $U \setminus B$. This means that B is not 1-LCC at any point as we wanted to show.

5.4. Exercises

EXERCISE 5.1. (PS2.1) Prove that the arc γ in Figure 5.23 is locally flat, and indeed there is a homeomorphism f of pairs mapping (\mathbb{R}^3, γ) to $(\mathbb{R}^3, [0, 1])$.

Hint: Find a nested sequence of balls $\{B_i\}$ so that $\cap B_i$ is the compactification point and each B_i intersects γ at a single point. For each i there is an isotopy that is the identity on $(S^3 \setminus \text{Int } B_i) \cup B_{i+1}$ and that straightens out $\gamma \cap (B_i \setminus \text{Int } B_{i+1})$. The desired homeomorphism f is a limit of a composition of such homeomorphisms.

EXERCISE 5.2. (PS2.2) The arc δ is the union of γ and a standard interval $[0, 1]$ (see Figure 5.23). Prove that δ is not locally flat. The arc δ is an example of a ‘mildly wild’ arc, i.e. it is a union of two locally flat arcs.

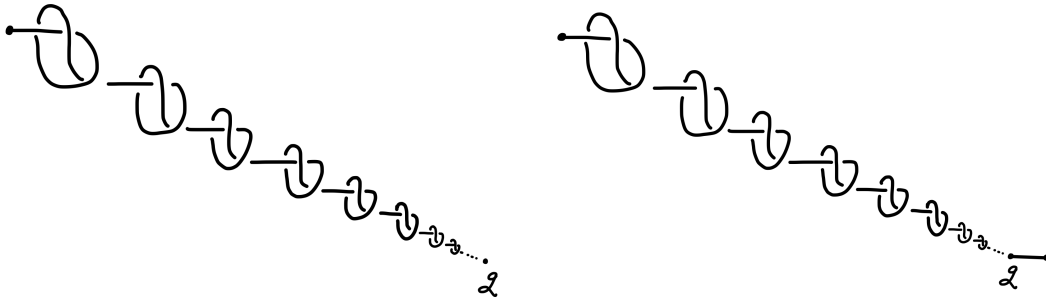

FIGURE 5.23. Arcs γ and δ respectively.

Hint: use the Seifert-van Kampen theorem to prove that δ is not 1-alg at the “union point”.

The Schoenflies theorem

Danica Kosanović, Mark Powell, and Arunima Ray

6.1. Overview of proof strategy

The goal is to prove that every locally flat embedding $i: S^{n-1} \hookrightarrow S^n$ bounds a ball on both sides. By Corollary 4.6, we may assume that the embedding is bicollared.

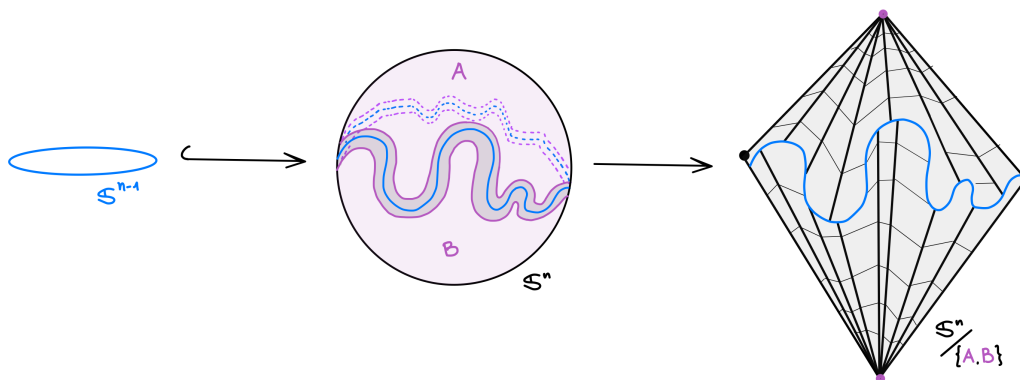

FIGURE 6.1. Idea of the proof of Schoenflies theorem: collapse the two components of the complement of a bicollar. Between the second and third pictures, the collar has been stretched out to cover most of the sphere, and the complementary regions have been shrunk to the two poles.

The key point is that the result of crushing each boundary component of an annulus $S^{n-1} \times [-1, 1]$ to a (distinct) point is the sphere S^n , in other words, the sphere S^n is identified with the unreduced suspension of the sphere S^{n-1} . By the Jordan-Brouwer separation theorem (Corollary 2.9), we know that $S^n \setminus (i(S^{n-1}) \times [-1, 1])$ has two components, call them A and B . (In fact, since we have a bicollared embedding, we can prove this much faster using the Mayer-Vietoris sequence.) Our goal will be to crush each of A and B to a point. The result is then seen to be the sphere S^n . This shows that there is a homeomorphism $(i(S^{n-1}) \times [0, 1]) / A \rightarrow D^n$ where the latter is a hemisphere of S^n . This does not seem like progress unless we know something about the quotient space $(i(S^{n-1}) \times [0, 1]) / A$. In fact, we will show that there is a homeomorphism

$$A \cup (i(S^{n-1}) \times [0, 1]) \xrightarrow{\cong} (i(S^{n-1}) \times [0, 1]) / A \cong D^n.$$

This leads us to the following abstraction.

Question 6.1. Given $X \subseteq M^n$, when is $M/X \cong M$?

Consider the three examples in Fig. 6.2. The first two are not hard to see, but how would you prove the last one, that for the topologist's (closed) sine curve $X = S$ we have $D^2/S \cong D^2$? We explore answers to these questions in the following two sections.

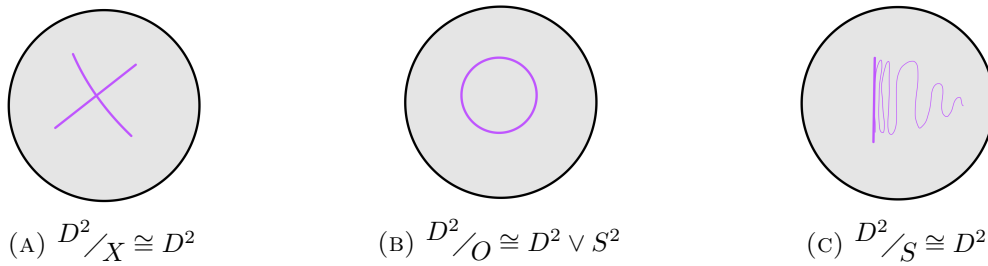
FIGURE 6.2. Some quotients of D^2 .

6.2. Whitehead manifold

In this short interlude, we describe a famous example of a subset $X \subseteq S^3$ where S^3/X is not homeomorphic to S^3 .

Let $V_0 \subseteq \mathbb{R}^3$ be the unknotted solid torus $S^1 \times D^2$. Let V_1 be the embedded solid torus in V_0 shown in Fig. 6.3. In other words, we have a homeomorphism $h: V_0 \rightarrow S^1 \times D^2 = V_1$.

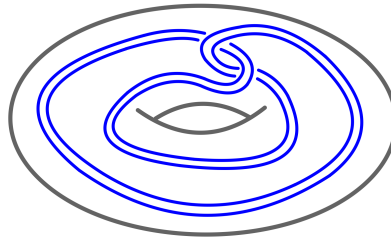

FIGURE 6.3. The building block for the Whitehead manifold.

Recursively define solid tori $V_i := h(V_{i-1})$. The infinite intersection $X := \bigcap V_i$ is called the *Whitehead continuum*, and its complement $\mathcal{W} := S^3 \setminus X$ is called the *Whitehead manifold*.

EXERCISE 6.1. (Non-HW) The Whitehead manifold is contractible. *Hint:* Use Theorem 3.5.

EXERCISE 6.2. (Non-HW) The quotient S^3/X is not a manifold. *Hint:* show that the quotient is not 1-LCC at the image of X . Prior knowledge of 3-manifold topology and knots and links will be useful.

Definition 6.2. A noncompact space M is *simply connected at infinity* if for every compact set $C_1 \subseteq W$ there exists a compact set $C_2 \supseteq C_1$ so that $\pi_1(W \setminus C_2) \rightarrow \pi_1(W \setminus C_1)$ is trivial.

The solution of the previous exercise in fact shows that the Whitehead manifold \mathcal{W} is not simply connected at infinity. Since \mathbb{R}^3 is simply connected at infinity, this shows that the Whitehead manifold is not homeomorphic to \mathbb{R}^3 .

The Whitehead manifold is historically significant. Whitehead wanted to prove the Poincaré conjecture by showing that any punctured homotopy 3-sphere is homeomorphic to \mathbb{R}^3 (this suffices by passing to 1-point compactifications). In this vein, he conjectured that any contractible, open 3-manifold is homeomorphic to \mathbb{R}^3 , but soon found the Whitehead manifold as a counterexample.

Remark 6.3. While the quotient S^3/X is not a manifold, it is known that $S^3/X \times \mathbb{R}$ is homeomorphic to \mathbb{R}^4 ! This can be proven using the techniques of the next section.

Remark 6.4. We have seen that simple connectivity at infinity is an obstruction to being homeomorphic to Euclidean space. It turns out that it is the only significant one. In other words, an open, contractible n -manifold is homeomorphic to \mathbb{R}^n if and only if it is simply

connected at infinity [Edw63, Wal65, Fre82b, Sta62a]. In dimension three this requires the Poincaré conjecture [Per02, Per03b, Per03a] (see also [MT07, KL08]).

6.3. Shrinking cellular sets

We are working towards the proof of the Schoenflies theorem by Brown [Bro60]. This material can also be found in [DV09b, Dav07, Bin83].

Definition 6.5. Let M^n be a manifold. A subset $X \subseteq \text{Int } M$ is *cellular* if there exist embedded, closed subsets $B_i \subseteq M$, $i \geq 1$, such that

- $B_i \cong D^n$ for all i ;
- $B_{i+1} \subseteq \overset{\circ}{B}_i$ for all i ; and
- $X = \bigcap_{i=1}^{\infty} B_i$.

Equivalently, X is closed and for every open $U \supseteq X$ there exists $B \cong D^n$ and $X \subseteq \overset{\circ}{B} \subseteq B \subseteq U$.

The name cellular is because D^n in an n -cell. It does not mean the space is a CW complexes.

Example 6.6. The first and last example from Fig. 6.2 are cellular, as can be seen in Fig. 6.4.

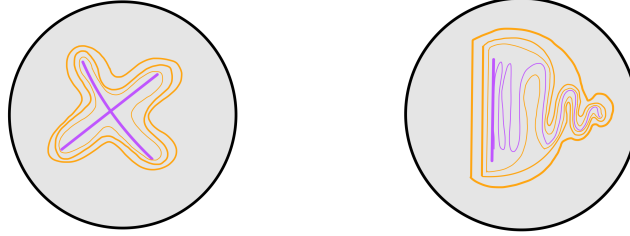

FIGURE 6.4. Examples of cellular sets, with $\{B_i\}$ in orange.

Proof of equivalence of definitions. Suppose that the first definition holds. Then $X = \bigcap_{i=1}^{\infty} B_i$, which is closed since each B_i is closed. Thus, $X \subseteq B_1$ is a closed subset of a compact set so is compact.

We claim that given $U \supseteq X$ open, there is a natural number n such that $B_n \subseteq U$. Suppose this is false. Then there exists a sequence $\{x_i\}$ with $x_i \in B_i \cap (M \setminus U) \neq \emptyset$ for each i . Since $\{x_i\} \subseteq B_1$, which is sequentially compact, after passing to a convergent subsequence, we have a limit point x . Then $x \in \bigcap_{i=1}^{\infty} B_i = X \subseteq U$, since each B_i is sequentially compact. But $M \setminus U$ is closed, so contains all its limit points, so $x \in M \setminus U$, which is a contradiction.

Suppose now the second definition holds. Since $\text{Int } M$ is open, by hypothesis there exists $B_1 \cong D^n$ such that $X \subseteq \overset{\circ}{B}_1 \subseteq B_1 \subseteq \text{Int } M$. Since X is closed and B_1 is compact, we have that X is compact. Let us now recursively define B_i so that $X \subseteq \overset{\circ}{B}_i \subseteq B_i \subseteq \overset{\circ}{B}_{i-1}$. Fix some metric d on M (recall that manifolds are metrisable, see Theorem 1.9)

Firstly, for $i \in \mathbb{Z}$ define the open set

$$U_i := \left\{ y \in M \mid d(X, y) < \frac{1}{i} \right\}.$$

Since $\overset{\circ}{B}_{i-1} \cap U_i$ is open, by hypothesis we can pick $B_i \subseteq \overset{\circ}{B}_{i-1} \cap U_i$ such that $B_i \cong D^n$ and $X \subseteq \overset{\circ}{B}_i$. By construction $X = \bigcap B_i$, since the elements in the intersection must have zero distance from X . This completes the proof. \square

The following proposition is why we are interested in cellular sets.

PROPOSITION 6.7. *Let M be a manifold. If $X \subseteq \text{Int } M$ is cellular, then $M \cong M/X$.*

Remark 6.8. In fact, the above proposition can be strengthened to say that the quotient map $\pi: M \rightarrow M/X$ can be “approximated by homeomorphisms”, that is we say that X *shrinks*. In order to understand how to approximate functions we need to have a metric on the collection of functions, which is what we recall in the next remark.

Remark 6.9 (Function spaces.). Let X and Y be compact metric spaces. The *uniform metric* is defined as

$$d(f, g) := \sup_{x \in X} d_Y(f(x), g(x)),$$

for continuous maps $f, g: X \rightarrow Y$. We write $\mathcal{C}(X, Y)$ for the metric space of continuous functions from X to Y equipped with this metric. By [Mun00a, Thm. 43.6 and 45.1], $\mathcal{C}(X, Y)$ is complete. For $A \subseteq X$, let

$$\mathcal{C}_A(X, X) := \{f \in \mathcal{C}(X, X) \mid f|_A = \text{Id}_A\}.$$

Note that $\mathcal{C}_A(X, X) \subseteq \mathcal{C}(X, X)$ is closed, so $\mathcal{C}_A(X, X)$ is complete with respect to the induced metric.

Remark 6.10. Let M be a compact manifold and $X \subseteq M$. For X closed, the quotient space M/X is metrisable. Then the quotient map $\pi: M \rightarrow M/X$ is said to be *approximable by homeomorphisms*, that is the set X is said to *shrink*, if there is a sequence $\{h_i: M \xrightarrow{\cong} M/X\}$ of homeomorphisms converging to π .

Remark 6.11. While we will not prove it in this course, a closed subset $X \subseteq \text{Int } M$ of a manifold shrinks if and only if X is cellular (see e.g. [Dav07]). Observe that asking for the quotient map to be approximable by homeomorphisms is stronger than merely requiring the quotient space to be homeomorphic to the original manifold M . A natural question then is whether whenever we have $M/X \cong M$ the set X must be cellular. We will see presently that $\mathbb{R}^n/X \cong \mathbb{R}^n$ implies that X is cellular. However this is not true in general.

We will use the following notion in the proof.

Definition 6.12. For a continuous map $f: X \rightarrow Y$ and $y \in Y$ we say $f^{-1}(y)$ is an *inverse set* if $|f^{-1}(y)| > 1$.

Proof of Proposition 6.7. We restrict to the case M is compact. The aim is to describe a surjective continuous map $f: M \rightarrow M$ with $f|_{\partial M} = \text{Id}$, whose only inverse set is X . Then we will obtain a well-defined continuous map $\bar{f}: M/X \rightarrow M$ completing the diagram

$$\begin{array}{ccc} M & \xrightarrow{f} & M \\ \downarrow \pi & \nearrow \exists \bar{f} & \\ M/X & & \end{array}$$

since f is constant on the fibres of π . Since \bar{f} is bijective, and is a closed map by the closed map lemma (Lemma 2.10) it will follow that it is a homeomorphism. Note that on ∂M we will have $\bar{f} \circ \pi = \text{Id}$.

Since X is cellular, there exist embedded, closed subsets $B_i \subseteq M$, $i \geq 1$, such that $B_i \cong D^n$ for all i , $B_{i+1} \subseteq \overset{\circ}{B}_i$ for all i , and $X = \bigcap_{i=1}^{\infty} B_i$. Fix a metric on M (which is metrisable by Theorem 1.9). We will define f as a limit of a sequence of homeomorphisms. First we define maps $f_i: M \rightarrow M$ recursively. Set $f_0 = \text{Id}_M$ and assume for the inductive step that $f_i: M \xrightarrow{\cong} M$ has been defined. Let $g'_i: D^n \rightarrow B_i \subseteq M$ be a homeomorphism.

CLAIM. For each $i \geq 1$ there exists a homeomorphism $h_i: M \rightarrow M$ shrinking $f_i(B_{i+1})$ in $f_i(B_i)$ to diameter less than $\frac{1}{i+1}$ and $h_i|_{M \setminus \text{Int}(f_i(B_i))} = \text{Id}$.

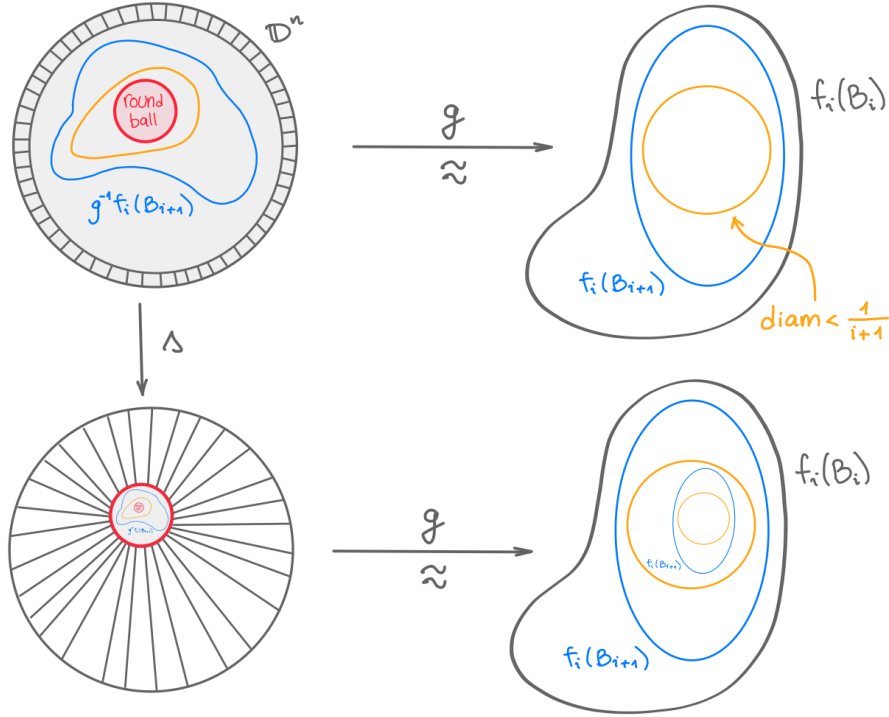

FIGURE 6.5. Proof of Proposition 6.7: the map s shrinks the complement of the collar to the round ball.

Proof of the claim. Consider the homeomorphism $g := f_i \circ g'_i: D^n \rightarrow f_i(B_i)$. Let s be the shrinking map as in Figure 6.5. More precisely, we choose a closed collar neighbourhood C of ∂D^n which is disjoint from $g^{-1}f_i(B_{i+1})$. This exists since the latter set is closed. Choose a round ball $U \subseteq D^n$ of diameter r so that $g(U) \subseteq f_i(B_{i+1})$ and $g(U)$ has diameter $< \frac{1}{i+1}$. The map s shrinks $D^n \setminus C$ until it lies within U , while acting by the identity on ∂D^n , stretching out the collar C to interpolate. It is instructive to think of this as a radial shrink.

Then define $h_i: M \rightarrow M$ by setting $h_i|_{M \setminus f_i(B_i)} = \text{Id}$ and $h_i|_{f_i(B_i)} = g \circ s \circ g^{-1}$. \square

Now we finish the inductive step by defining

$$f_{i+1} := h_i \circ f_i: M \xrightarrow{\cong} M$$

Note that $\text{diam}(f_i(B_i)) < \frac{1}{i}$ for all i and $f_{i+1} = f_i$ on $M \setminus f_i(B_i)$. We also have that $f_i|_{\partial M} = \text{Id}$.

We assert that $\{f_i\}$ is a Cauchy sequence in the complete metric space of functions $\mathcal{C}_{\partial M}(M, M)$ (Remark 6.9), by showing that $d(f_m, f_n) < 1/n$ for $m > n$. Indeed, these maps agree on $M \setminus f_n(B_n)$, while for $x \in B_n$, both $f_m(x)$ and $f_n(x)$ lie in $f_n(B_n)$ (since $f_m(x) = h_{m-1} \circ h_{m-2} \circ \dots \circ f_n(x)$), and $\text{diam } f_n(B_n) < 1/n$.

Finally, define $f := \lim\{f_i\}$. We have that $f|_{\partial M} = \text{Id}$ since each f_i restricts to the identity on ∂M . It remains only to show that f has the desired inverse sets.

Firstly, we claim that $f(X) = \{y\}$. Otherwise, for $x, x' \in X$ with $f(x) = y \neq y' = f(x')$, we can choose $i \geq 1$ such that $d(f, f_i) < \frac{d(y, y')}{3}$ and $\frac{1}{i} < \frac{d(y, y')}{3}$, so

$$\begin{aligned} d(y, y') &= d(f(x), f(x')) \leq d(f(x), f_i(x)) + d(f_i(x), f_i(x')) + d(f_i(x'), f(x')) \\ &< \frac{d(y, y')}{3} + \frac{1}{i} + \frac{d(y, y')}{3} < d(y, y') \end{aligned}$$

which is a contradiction. Here we used the fact that $\text{diam } f_i(X) < 1/i$.

Secondly, observe that $f|_{M \setminus X}$ is injective. Namely, for any $p, q \in M \setminus X$ there is $i \geq 1$ such that $p, q \notin B_i$, so $f(p) = f_i(p)$ and $f(q) = f_i(q)$. If $f(p) = f(q)$ then $f_i(p) = f_i(q)$, but f_i is a homeomorphism, so $p = q$.

Finally, we claim that $f(X) \cap f(M \setminus X) = \emptyset$. Let $x \in X$. Again, for $p \in M \setminus X$ we have $f(p) = f_i(p)$ for some $i \geq 1$ such that $p \notin B_i$, so $f(p) = f_i(p)$ if $x \in X \subseteq B_{i+1}$ then

$$d(f(p), f(x)) = d(f_i(p), f(x)) \geq d(f_i(p), f_i(B_{i+1})) > 0.$$

For the final inequality we used that $d(p, B_{i+1}) > 0$ (since $B_{i+1} \subseteq \overset{\circ}{B}_i$ and $p \notin B_i$) and f_i is a homeomorphism. Therefore, $f(p) \neq f(x)$, finishing the proof that the only inverse set of f is X , as desired. \square

From the sketch of the proof of the Schoenflies theorem at the beginning of this section, we should remember that the goal was to quotient out the sphere by the complementary components of the given embedding and conclude that the result is still a sphere. The above result indicates that we will be able to do so if these complementary regions are cellular, and indeed they are, as we will see in the following two propositions.

PROPOSITION 6.13. *Let $f: D^n \rightarrow S^n$ be a continuous map with $X \subseteq \text{Int } D^n$ the only inverse set. Assume that $f(\text{Int } D^n)$ is open in S^n . Then X is cellular in D^n .*

Remark 6.14. The assumption that $f(\text{Int } D^n)$ is open in S^n is in fact redundant, as we will see in Lemma 6.17. However, the proof of Lemma 6.17 is somewhat involved so the reader may prefer to skip it.

Proof. By invariance of domain we know that $f(D^n) \neq S^n$. Specifically, if the map were surjective, then for a boundary point of D^n we would get a neighbourhood homeomorphic to \mathbb{R}^n which is impossible. Choose a point $z \in S^n \setminus f(D^n)$ and identify $S^n \setminus \{z\}$ with \mathbb{R}^n . Let $f(X) =: y \in S^n$ and let U be some open set with $X \subseteq U \subseteq D^n$. Then $f(U)$

We again have the diagram

$$\begin{array}{ccc} D^n & \xrightarrow{f} & S^n \\ \downarrow \pi & \nearrow \exists \bar{f} & \\ D^n/X & & \end{array}$$

where \bar{f} is an embedding. Then since $U \subseteq \text{Int } D^n$ is a saturated open set, we know that $\pi(U)$ is open in D^n/X by the definition of the quotient topology, and then since \bar{f} is an embedding $f(U) = \pi \circ \bar{f}(U)$ is open in $f(\text{Int } D^n)$. Since $f(\text{Int } D^n)$ is open in S^n by hypothesis, we have that $f(U)$ is open in S^n .

We want to find an open ball in U containing X , implying that X is cellular (by the second definition). Using that $f(U)$ is an open neighbourhood of y and $f(D^n)$ is compact, we choose

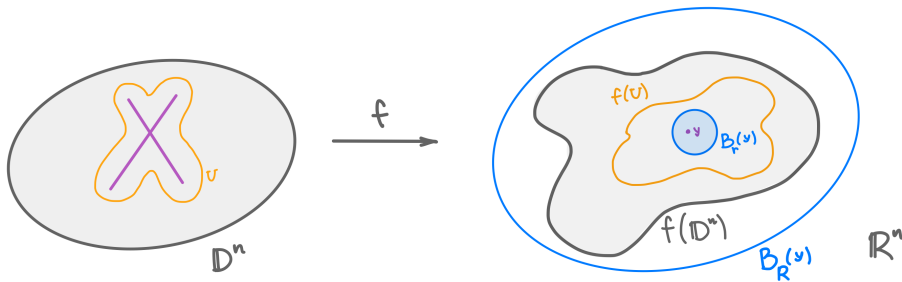

FIGURE 6.6. Proof of Proposition 6.13

$r, R > 0$ such that $B_r(y) \subseteq f(U) \subseteq f(D^n) \subseteq B_R(y)$ as in Fig. 6.6. Let $\mathfrak{s}: S^n \rightarrow S^n$ be a ‘shrinking’ map similar to before (cf. Fig. 6.5), such that $\mathfrak{s}|_{B_{r/2}(y)} = \text{Id}$ and

$$\mathfrak{s}(f(D^n) \subseteq \mathfrak{s}(B_R(y))) \subseteq B_r(y) \subseteq f(U).$$

Then define a map $\sigma: D^n \rightarrow D^n$ by

$$x \mapsto \begin{cases} x, & x \in X \\ f^{-1}\mathfrak{s}f(x), & x \notin X. \end{cases}$$

Note that in the second case $\mathfrak{s}f(x) \neq y$, so there is a unique preimage under f , implying that σ is a well-defined map. It is continuous (since f is a closed map restricted to $M \setminus X$) and a homeomorphism onto its image (by the closed map lemma (Lemma 2.10)). Therefore, $\sigma(D^n)$ is the desired ball, since $X \subseteq \sigma(\mathring{D}^n) \subseteq \sigma(D^n) \subseteq f^{-1}\mathfrak{s}f(D) \subseteq f^{-1}f(U) = U$. \square

Getting even closer to the situation of the Schoenflies theorem, we now generalise to a map from a sphere with two inverse sets.

PROPOSITION 6.15. *Suppose $f: S^n \rightarrow S^n$ is surjective, continuous, and has precisely two inverse sets A and B . Then each of A and B are cellular.*

Proof. In an effort to prevent confusion, let S and T denote the domain and codomain respectively, so $f: S \rightarrow T$. Let $a := f(A)$ and $b := f(B)$. Since A and B are closed and disjoint, we can pick a standard open disc $U \subseteq S$, disjoint from A and B . Then $D := S \setminus U \cong D^n$ is a disc and $A \cup B \subseteq \mathring{D}$.

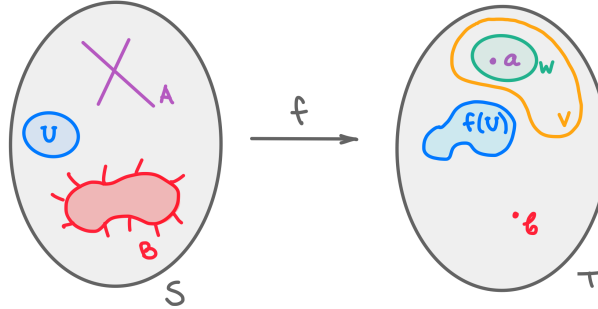

FIGURE 6.7. Proof of Proposition 6.15

Choose an open set $V \subseteq f(\mathring{D})$ with $a \in V$ and $b \notin V$. We can find such a V because $f(\mathring{D}) = T \setminus f(\overline{U})$ is open, since $f(\overline{U})$ is closed (as f is a closed map by the closed map lemma (Lemma 2.10)).

Now choose a homeomorphism $h: T \rightarrow T$ such that $f(D)$ is mapped to V , fixing some set W with $a \in W \subsetneq V$. Similarly as in the proof of the previous proposition we have a well-defined map $\psi: D \rightarrow S$ mapping

$$x \mapsto \begin{cases} x & x \in f^{-1}(W) \\ f^{-1}hf(x) & x \in D \setminus A. \end{cases}$$

since f^{-1} is one-to-one on $V \setminus \{a\}$.

As before we see that ψ is continuous using the pasting lemma and the fact that f is a closed map on $S \setminus (A \cup B)$.

Our goal is to apply Proposition 6.15 to ψ . We check that $B \subseteq \mathring{D}$ is the only inverse set. This is the case since A is in the ‘identity’ part of the definition of ψ , and h is a homeomorphism so $f^{-1}hf$ has same inverse set as $f|_{D \setminus A}$ (since h maps $f(D)$ into V), which is just B . Moreover,

we check that $\psi(\mathring{D}) = f^{-1}hf(\mathring{D})$ is open since f is continuous, h is a homeomorphism, and we saw earlier that $f(\mathring{D})$ is open.

Therefore, by Proposition 6.13 applied to ψ the set B is cellular. By a similar argument A is cellular as well. \square

Remark 6.16. You might be wondering why we did not directly find a ball neighbourhood D of A disjoint from B and apply Proposition 6.13 to it. A priori all we know about A and B is that they are closed sets, as preimages of closed sets. Then finding such a ball neighbourhood of A amounts precisely to showing that A has such a ball neighbourhood in the open set $S \setminus B$. With little information about B , i.e. when this open neighbourhood is arbitrary, this is the same as showing that A is cellular.

The proof of the following lemma can be safely skipped.

LEMMA 6.17. *Let $f: D^n \rightarrow S^n$ be a continuous map with finitely many inverse sets, all lying within $\text{Int } D^n$. Then $f(\text{Int } D^n)$ is open in S^n .*

Proof. As before by invariance of domain we know that $f(D^n) \neq S^n$. Choose a point $P \in S^n \setminus f(D^n)$. Let X denote the union of all the inverse sets. As a finite union of closed sets it is closed. Define $U := (\text{Int } D^n) \setminus X$ and observe it is open in D^n . It is nonempty since otherwise $X \cap \partial D^n \neq \emptyset$. Then $f|_U$ is an injective continuous map from an open subset of \mathbb{R}^n to $\mathbb{R}^n = S^n \setminus \{P\}$, so by invariance of domain, $f(U)$ is open in S^n and $f|_U$ is a homeomorphism. Then for all $z \in U$, $f(z)$ lies in the interior of $f(\text{Int } D^n)$. It remains only to show that the *singular points* of f , that is, the images of the inverse sets, lie in the topological interior of $f(\text{Int } D^n)$. Let Y denote the collection of singular points of f . By hypothesis Y is a finite collection of isolated points.

Let $y \in Y$ be a singular point of f . Choose a sequence $\{a_i\} \subseteq U$ such that $\{a_i\} \rightarrow x$ for some $x \in X$ with $f(x) = y$. Then we know that the sequence $\{f(a_i)\} \subseteq f(U)$ converges to y by the continuity of f . Suppose y is not in the topological interior of $f(\text{Int } D^n)$. Then, perhaps after passing to a subsequence, choose open coordinate ball neighbourhoods $\{B_i\}$ centred at y and with strictly decreasing radii converging to 0, such that $f(a_i) \in B_i$ for all i and choose $w_i \in B_i \cap (S^n \setminus f(\text{Int } D^n)) \neq \emptyset$ so that $\{w_i\} \rightarrow y$. Within each B_i choose a path γ_i joining w_i and $f(a_i)$ with $\gamma_i \cap Y = \emptyset$ and a parametrisation $\alpha_i: [0, 1] \rightarrow S^n$ with $\alpha_i(0) = f(a_i)$ and $\alpha_i([0, 1]) = \gamma_i$. Such a path can be found since Y is a finite set. Then $\alpha_i^{-1}(f(U))$ is open for each i since $f(U)$ is open in S^n . For each i let $[0, \tau_i)$ denote the component of $\alpha_i^{-1}(f(U))$ containing 0. Then we have $f^{-1}\alpha_i([0, \tau_i)) \subseteq U$.

Fix i . Note that $\alpha_i(\tau_i) \notin Y$ by construction and thus $f^{-1}\alpha_i(\tau_i)$ is a single point v_i . We claim that $v_i \in \partial D^n$. We know that $v_i \notin U$ since then $\alpha_i(\tau_i) \in f(U)$ which is a contradiction. If $v_i \in X$, then $f(v_i) = \alpha_i(\tau_i) \in Y$ which is a contradiction. Thus, $v_i \in \partial D^n$.

We have seen that $\{v_i\} \subseteq \partial D^n$ where the latter is a compact space. Thus, we assume that $\{v_i\}$ converges after passing to a convergent subsequence. Let $u \in \partial D^n$ denote the limit of $\{v_i\}$. By continuity of f , $\{f(v_i)\} \rightarrow f(u) \in f(\partial D^n)$. On the other hand, by construction, $\{f(v_i)\} \rightarrow y$, since each $f(v_i) \in B_i$ and $\{B_i\}$ are centred at y with radii decreasing to 0. Since limits of sequences are unique in Hausdorff spaces, we have that $y = f(u)$ for $u \in \partial D^n$, which implies that $X \cap \partial D^n \supseteq f^{-1}(y) \cap \partial D^n \neq \emptyset$, which is a contradiction. \square

We are now in shape to prove the Schoenflies theorem, following Brown [Bro60].

Remark 6.18. Prior to Brown's work, an alternative proof was given by Mazur in [Maz59] in the case that the embedding has a "flat spot". This hypothesis was removed by Morse in [Mor60], just a few pages after Brown's proof [Bro60] in the same journal. Mazur's argument uses an infinite stacking procedure, and the cancellation procedure known as the *Mazur swindle*. Both approaches are worth knowing, in particular since the smooth Schoenflies conjecture for $S^3 \subseteq S^4$ remains open. Nonetheless we cite Brown for the theorem since he provided the first complete argument.

THEOREM 6.19 (Generalised Schoenflies theorem). *Let $n \geq 1$ and let $i: S^{n-1} \hookrightarrow S^n$ be a locally flat embedding. Then there is a homeomorphism of pairs $(S^n, i(S^{n-1})) \cong (S^n, S^{n-1})$, where the latter is the equatorial sphere S^{n-1} in S^n .*

In particular, the closure of each component of $S^n \setminus i(S^{n-1})$ is homeomorphic to D^n .

Proof. By Corollary 4.6 we know i is bicollared: there is an embedding $I: S^{n-1} \times [-1, 1] \rightarrow S^n$ such that $I|_{S^{n-1} \times \{0\}} = i$. Moreover, by Jordan-Brouwer Separation (Corollary 2.9), the complement has two components; see Fig. 6.1. Observe that we could also have applied the Mayer-Vietoris sequence directly, since we have a bicollar.

Now consider the composite

$$f: S^n \xrightarrow{\pi} S^n / \{A, B\} \xrightarrow{\cong} S^n,$$

where the quotient map collapses each of A and B to a (distinct) point and the second map is the homeomorphism identifying the unreduced suspension of S^{n-1} with S^n . Note that f maps $i(S^{n-1})$ to the equatorial sphere $S^{n-1} \subseteq S^n$. Since f has precisely two inverse sets A and B , by Proposition 6.15 we have that A and B are both cellular. Let

$$U := A \cup I(S^{n-1} \times (0, 1]),$$

namely the component of $S^n \setminus i(S^{n-1})$ containing A . Then $f|_{\bar{U}}: \bar{U} \rightarrow D \cong D^n$, the upper hemisphere of S^n . We check that \bar{U} is a manifold. As a subspace of S^n it is Hausdorff and second countable. The interior U is an open set of S^n so the only potential problem is at the boundary. But since we have the bicollar, the boundary points are also well behaved.

In the diagram below we have the function \bar{f} as before, using the fact that $f|_{\bar{U}}$ is constant on the fibres of π . Then $\bar{f} \circ \pi = f|_{\bar{U}}$. Since A is cellular, by Proposition 6.7 there exists a homeomorphism h with $h|_{\partial \bar{U}} = \pi|_{\partial \bar{U}}$.

$$\begin{array}{ccc} \bar{U} & \xrightarrow{f|_{\bar{U}}} & D \cong D^n \\ \downarrow \pi & \cong \nearrow \exists \bar{f} & \\ \bar{U}/A & & \end{array} \quad \exists h \cong$$

Then we have the homeomorphism $\bar{f} \circ h: \bar{U} \rightarrow D^n$, and moreover, $\bar{f} \circ h|_{\partial \bar{U}} = \bar{f} \circ \pi|_{\partial \bar{U}} = f|_{\partial \bar{U}}$. A similar argument for B and $V := B \cup I(S^{n-1} \times (0, 1])$ shows that \bar{V} is homeomorphic to the lower hemisphere of S^n . Moreover, since the induced maps on the boundary coincide, we can glue the maps together to get a homeomorphism $H: S^n \rightarrow S^n$ mapping $i(S^{n-1})$ to the equatorial $S^{n-1} \subseteq S^n$ as desired. \square

6.4. Schoenflies in the smooth category

The proof given above only applies in the topological category. In particular, there is no analogue of Proposition 6.7 in the smooth category. Nonetheless, the smooth Schoenflies theorem is known in almost all dimensions, as we now sketch. See [Mil65, Sec. 9] for further details.

THEOREM 6.20 (Schoenflies theorem, smooth version). *Let Σ be a smooth embedded S^{n-1} in S^n . If $n \geq 5$, then there exists a diffeomorphism of pairs $(S^n, \Sigma) \rightarrow (S^n, S^{n-1})$.*

Proof. The complement $S^n \setminus \Sigma$ has two components, by Corollary 2.9 or directly applying the Mayer-Vietoris sequence. It is easy to check that the closure of each component of $S^n \setminus \Sigma$ is a smooth simply connected n -manifold, with boundary diffeomorphic to S^{n-1} , and which has integral homology of the n -ball (i.e. it is a \mathbb{Z} -homology ball).

CLAIM. *For $n \geq 5$, every smooth, compact, simply connected integer homology balls with boundary diffeomorphic to S^{n-1} is diffeomorphic to D^n .*

We will also need the following theorem.

THEOREM 6.21 (Palais [Pal60]). *Any two smooth orientation-preserving smooth embeddings of D^n in a connected oriented smooth n -manifold are smoothly equivalent (that is, there is an orientation-preserving diffeomorphism of the ambient manifold taking one to the other).*

Given the above two ingredients, we prove the theorem as follows. By Palais's theorem we can obtain a diffeomorphism of S^n taking one component of $S^n \setminus \Sigma$ to the standard hemisphere of S^n . This diffeomorphism must then take the other component to the other hemisphere, and their shared boundary Σ to the equator, giving the desired diffeomorphism of pairs. \square

Proof of the claim. Let W^n be a smooth compact simply connected \mathbb{Z} -homology n -ball with $\partial W \cong_{C^\infty} S^{n-1}$.

Remove a small ball $D_0 \subseteq \text{Int } W$. Then $W \setminus \overset{\circ}{D}_0$ is an h -cobordism, i.e. a smooth manifold with precisely two boundary components, such that the inclusion of each boundary component is a homotopy equivalence.

By the h -cobordism theorem of Smale [Sma62a] (see also [Mil65]), since $n \geq 6$ and $W \setminus \overset{\circ}{D}_0$ is simply connected, we have that $W \setminus \text{Int } D_0 \cong_{C^\infty} S^{n-1} \times [0, 1]$. Therefore, by putting the disc D_0 back in we have $W \cong D^n$.

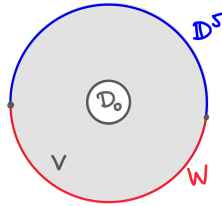

FIGURE 6.8. The proof of the Schoenflies theorem in the smooth category for $n = 5$.

For $n = 5$ we need a bespoke argument. Let $M = W \cup_f D^5$ where $f: \partial W \xrightarrow{\cong_{C^\infty}} S^4 = \partial D^5$. Then M is a $\mathbb{Z}HS^5$ (i.e. has the integral homology of S^5). Then by [Ker69, KM63a, Wal62] we know that $M = \partial V$ for some smooth compact contractible 6-manifold V , see Fig. 6.8.

Now run the same argument as above: remove a small disc D_0 from V to get $V \setminus \text{Int } D_0 \cong_{C^\infty} S^5 \times [0, 1]$. Therefore, $M \cong_{C^\infty} S^5$ and we can again use Palais's theorem to conclude that $W \cong_{C^\infty} D^5$. \square

Remark 6.22. The smooth Schoenflies theorem also holds in dimensions less than or equal to 3. In dimension one it only requires that S^1 is path connected, in dimension two the Riemann mapping theorem gives a proof. In dimension 3, the result is known as Alexander's theorem [Ale24] (see Hatcher's 3-manifolds notes for a more modern exposition.) In dimension four, the Schoenflies problem remains open (and is equivalent to the version in the PL category).

Remark 6.23. We may wonder to what extent the techniques in this section apply to the topological category. The h -cobordism theorem is an extremely powerful tool, but the proof fundamentally uses handle decompositions. Handle decompositions exist in the smooth category. Work of Kirby-Siebenmann can be used to find *topological* handle decompositions – explaining this is one of the goals of our course. Characteristically, this will be harder than in the smooth category. Every topological manifold, other than non-smoothable 4-manifolds, admit topological handle decompositions. A fun fact: smooth, compact, simply connected 5-dimensional h -cobordisms are not in general smoothly products (as shown by Donaldson [Don87]) but they are topologically products, i.e. homeomorphic to products (as shown by Freedman [Fre82b]).

Remark 6.24. Palais' theorem (Theorem 6.21) implies that connected sum of smooth manifolds is well-defined. To show that connected sum of topological manifolds is well-defined, we will need the topological Annulus Theorem. This is due to Kirby for $n \geq 5$, and we will study its proof later (Quinn proved it for $n = 4$).

Remark 6.25. Brown's proof of the Schoenflies theorem belongs in the beautiful field of *decomposition space theory*. Other notable applications include Freedman's proof of the 4-dimensional Poincaré conjecture [Fre82b] and Cannon's proof of the double suspension theorem [Can79a].

EXERCISE 6.3. Show that the following weak version of the Schoenflies theorem holds for all n in the smooth category: Let Σ denote a smoothly embedded S^{n-1} in S^n . If one of the two components of $S^n \setminus \Sigma$ is a smooth ball, then so is the other.

EXERCISE 6.4. Show that the smooth Poincaré conjecture implies the smooth Schoenflies conjecture, in any dimension. Does the converse hold? (Why not?)

EXERCISE 6.5. (PS3.1) Is the double Fox-Artin arc in the interior of D^3 cellular?

Note that the above exercise shows that cellularity is not a property of a space, but rather of an embedding. That is, we have found a non-cellular embedding of an arc in D^3 . Of course there also exist cellular embeddings of arcs in D^3 .

EXERCISE 6.6. (PS3.2) Let M be a compact n -manifold so that $M = U_1 \cup U_2$ where each U_i is homeomorphic to \mathbb{R}^n .

- (a) Prove that M is homeomorphic to S^n . You may use the Schoenflies theorem.
- (b) Conclude that if a closed n -manifold M is an (unreduced) suspension SX for some space X , then M is homeomorphic to the sphere S^n .

Note: (b) reduces the double suspension problem to showing that the double suspension is a manifold, not specifically a sphere.

Remark 6.26. The above can be shown independently of the Schoenflies theorem, using a result of Brown characterising Euclidean space [Bro61].

EXERCISE 6.7. (PS3.3) Let $\Sigma \subseteq S^n$ be an embedded copy of S^{n-1} and let U be one of the two path components of $S^n \setminus \Sigma$. If the closure \bar{U} is a manifold, then \bar{U} is homeomorphic to D^n .

EXERCISE 6.8. (PS3.4) Let $f: D^n \rightarrow D^n$ be a locally collared embedding of a disc into the interior of a disc. Prove that $D^n \setminus f(D^n)$ is homeomorphic to $S^{n-1} \times (0, 1]$. *Hint:* show that $f(D^n)$ is cellular.

Note, the result that $D^n \setminus \text{Int}(f(D^n))$ is homeomorphic to $S^{n-1} \times [0, 1]$, for $n \geq 4$, is the famous annulus theorem due to Kirby and Quinn. Why doesn't the annulus theorem follow easily from this exercise?

Spaces of embeddings and homeomorphisms

Mark Powell

In the upcoming chapters, we will develop a topological analogue of the tangent bundle of a smooth manifold. Essentially, this will lead to an \mathbb{R}^n -fibre bundle over our manifold with structure group $\text{Homeo}_0(\mathbb{R}^n)$. Hence we will need some terminology and facts about fibre bundles and groups of homeomorphisms, which is the content of this chapter. We also introduce spaces of embeddings, which generalise homeomorphisms, since a surjective embedding is a homeomorphism. Embedding spaces will be used often; the first instance is in the study of topological tangent bundles.

Definition 7.1. A *topological group* is a group G that is also a topological space, such that the group operation is a continuous map $G \times G \rightarrow G$ and such that the inverse map $g \mapsto g^{-1}$ is also a continuous map from G to itself.

Definition 7.2. A *fibre bundle* consists of a base space B , total space E and fibre F , together with a map $p: E \rightarrow B$, a topological group G with a continuous group action $G \times F \rightarrow F$ on F , a maximal collection $\{U_\alpha\}$ of open subsets of B and homeomorphisms $\varphi_\alpha: U_\alpha \times F \rightarrow p^{-1}(U_\alpha)$ called *charts*, such that

- (1) $\{U_\alpha\}$ covers B ;
- (2) for any $V \subseteq U_\alpha$ open, $\varphi_\alpha|_V$ is a chart;
- (3) the following diagrams commute:

$$\begin{array}{ccc}
 p^{-1}(U_\alpha) & & \\
 \uparrow \varphi_\alpha \cong & \searrow p| & \\
 U_\alpha \times F & & U_\alpha \\
 & \nearrow pr &
 \end{array}$$

- (4) if φ, φ' are charts over $U \subseteq B$, then there exists a continuous *transition function* $\theta_{\varphi, \varphi'}: U \rightarrow G$ such that for all $u \in U$ and $f \in F$ we have

$$\varphi'(u, f) = \varphi(u, \theta_{\varphi, \varphi'}(u) \cdot f).$$

Vector bundles are the special case, with $F = \mathbb{R}^n$ and $G = GL_n(\mathbb{R})$ or $O(n)$. There is a chain of inclusions of topological groups

$$O(n) \subseteq GL_n(\mathbb{R}) \subseteq \text{Diff}(\mathbb{R}^n) \subseteq \text{Homeo}(\mathbb{R}^n)$$

where $\text{Diff}(\mathbb{R}^n)$ is the topological group of diffeomorphisms of \mathbb{R}^n and $\text{Homeo}(\mathbb{R}^n)$ is the topological group of homeomorphisms of \mathbb{R}^n ; we discuss these spaces (and their topologies) in this section. The first inclusion is a homotopy equivalence, which can be seen by performing the Gram-Schmidt process in a parametrised fashion. The second is also homotopy equivalence. We will not give details of these facts here as they belong in the world of differential topology.

7.1. The compact-open topology on function spaces

Let $\text{Top}(n) := \text{Homeo}_0(\mathbb{R}^n)$ be the group of homeomorphisms of \mathbb{R}^n that fix the origin. This can be made into a topological group with the compact-open topology. We will be talking about such spaces frequently, so let us briefly explain the compact-open topology.

The compact-open topology is defined more generally, for $\mathcal{C}(X, Y)$, the set of all continuous functions from a space X to a space Y . By definition, it has a subbasis of open sets for $\mathcal{C}(X, Y)$ of the form

$$V(K, U) = \{f \in \mathcal{C}(X, Y) \mid f(K) \subseteq U\}$$

with $K \subseteq X$ compact and $U \subseteq Y$ open.

If a sequence of functions $\{f_i\}$ converges to $f: X \rightarrow Y$ in this topology, then the functions get closer to f (corresponding to smaller U) on progressively larger compact sets (corresponding to larger K). For details on the compact-open topology, we refer to [Hat02b, Appendix], for example. A standard exercise is the following.

PROPOSITION 7.3. *If X is compact, Y a metric space, then compact-open topology coincides with the uniform topology arising from $d_x(f, g) := \sup_{x \in X} d_y(f(x), g(x))$.*

Here are the key facts about the compact-open topology on continuous functions. Sometimes $\mathcal{C}(X, Y)$ is denoted Y^X .

PROPOSITION 7.4. *Let X, Y, Z be locally compact, Hausdorff spaces (for example topological manifolds).*

(1) *Composition*

$$\circ: \mathcal{C}(X, Y) \times \mathcal{C}(Y, Z) \rightarrow \mathcal{C}(X, Z)$$

is a continuous map.

(2) *$f: X \times Y \rightarrow Z$ is continuous if and only if its adjoint*

$$\begin{aligned} \hat{f}: Y &\rightarrow \mathcal{C}(X, Z) \\ y &\mapsto (x \mapsto f(x, y)) \end{aligned}$$

is continuous.

(3) *The adjoint map from the previous item gives rise to a homeomorphism*

$$\mathcal{C}(Y, \mathcal{C}(X, Z)) \xrightarrow{\cong} \mathcal{C}(X \times Y, Z).$$

This is sometimes called the exponential rule because it can be rephrased as $Z^{X \times Y} \cong (Z^X)^Y$.

(4) *The map*

$$\begin{aligned} \mathcal{C}(X, Y) \times \mathcal{C}(X, Z) &\rightarrow \mathcal{C}(X, Y \times Z) \\ (f, g) &\mapsto (x \mapsto (f(x), g(x))) \end{aligned}$$

is a homeomorphism. (This also has a nice exponential mnemonic $Y^X \times Z^X = (Y \times Z)^X$.)

(5) *If M is a manifold, $\text{Homeo}(M) \rightarrow \text{Homeo}(M)$ with $h \mapsto h^{-1}$ is continuous.*

COROLLARY 7.5. *For X, Y as above, the map $\text{ev}: X \times \mathcal{C}(X, Y) \rightarrow Y$ given by $(x, f) \mapsto f(x)$ is continuous.*

Proof. This follows from the exponential rule (3). Namely, it says that the adjoint map is surjective, so in particular $\text{Id} \in \mathcal{C}(\mathcal{C}(X, Y), \mathcal{C}(X, Y))$ is an adjoint of some continuous map $\theta \in \mathcal{C}(X \times \mathcal{C}(X, Y), Y)$. By definition, this means that $\hat{\theta}(f) = (x \mapsto \theta(x, f))$ is equal to $\text{Id}(f) = (x \mapsto f(x))$, so $\theta(x, f) = f(x)$ and $\theta = \text{ev}$. \square

Remark 7.6. Versions of these facts hold with the hypotheses on X , Y , and Z relaxed a little. Since we mostly care about topological manifolds, we restrict to all spaces locally compact and Hausdorff. References for the convenient category of topological spaces and k -ification include Steenrod’s paper and May’s concise course.

The key consequence of Proposition 7.4 is that with the compact-open topology $\text{Homeo}(M)$ is a topological group.

Remark 7.7. Why do we define the compact-open topology by only controlling functions on compact sets? Consider the space of homeomorphisms of \mathbb{R}^n fixing the origin, $\text{Homeo}_0(\mathbb{R}^n)$. Suppose we required that for f to lie in an open set around g , it must satisfy $|f(x) - g(x)| < \varepsilon$ for all $x \in \mathbb{R}^n$. Then for $g = \text{Id}$, no rotation f about 0 would satisfy this for any ε . So even the simple operation of rotating around the origin would not constitute an isotopy.

On the other hand with the compact-open topology, rotating does give rise to an isotopy of homeomorphisms.

7.2. Spaces of embeddings and isotopy

We can consider embeddings from X to Y , $\text{Emb}(X, Y)$ with the compact-open topology. This is the subspace of the continuous maps $\mathcal{C}(X, Y)$ consisting of all the injective continuous maps that are homeomorphisms onto their images.

An isotopy of embeddings $X \hookrightarrow Y$ is a continuous map $[0, 1] \rightarrow \text{Emb}(X, Y)$ or equivalently, a continuous map $\psi: X \times [0, 1] \rightarrow Y$ with $\psi(-, t)$ an embedding for each t (the equivalence follows from the exponential rule). We call this an isotopy between the embeddings $\psi(-, 0)$ and $\psi(-, 1)$.

Remark 7.8. Beware: under this definition, the trefoil and the unknot are isotopic, because we can pull the trefoil arbitrarily tight, until in the limit as $t \rightarrow 1$, it becomes the unknot. In knot theory, when people say colloquially that two knots are isotopic, they usually mean some other equivalence relation, such as “ambiently isotopic” as in the next definition, or smoothly isotopic.

Definition 7.9. Two embeddings $f, g: X \rightarrow Y$ are said to be *ambiently isotopic* if there exists

$$\Phi: [0, 1] \rightarrow \text{Homeo}(Y)$$

with $\Phi(0) = \text{Id}$ and $\Phi(1) \circ f = g$.

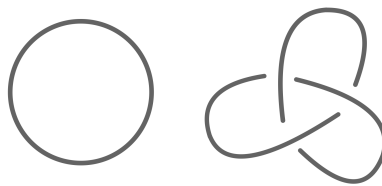
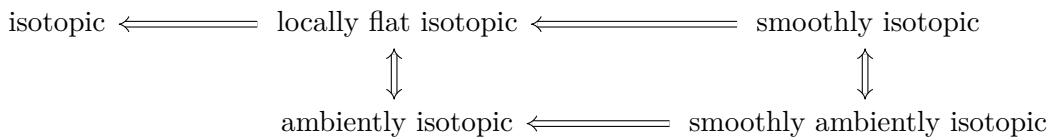

FIGURE 7.1. The unknot and the trefoil.

As expected, the trefoil and the unknot (see Fig. 7.1) are not ambiently isotopic. The following flowchart summarizes the relations between different notions of isotopy.



The upwards and the left implications are straightforward. The downwards implications use the isotopy extension theorems. The smooth isotopy extension theorem says that smooth isotopy and smooth ambient isotopy are equivalent. We used knots in S^3 as a convenient example here,

but these theorems apply to submanifolds more generally, although of course one needs smooth submanifolds to make sense of the implications involving smoothly isotopic or smoothly ambient isotopic. We will talk later about the topological isotopy extension theorem due to Edwards and Kirby, and the definition of a locally flat isotopy in detail later. The proof uses the torus trick.

The trefoil and the unknot are isotopic only in a rather weak sense, since they are neither locally flat isotopic, ambiently isotopic, smoothly isotopic, nor smoothly ambiently isotopic.

In the upcoming proof of Kister's theorem, we will construct an isotopy of embeddings which is not an ambient isotopy.

7.3. Immersions

Definition 7.10. A smooth map $f: M \rightarrow N$ between smooth manifolds is a *smooth immersion* if for every $x \in M$ the derivative $df|_x: T_x M \rightarrow T_{f(x)} N$ of f at x is injective. Equivalently, f is locally a (smooth) embedding.

We can use the second description to define an analogous notion in the topological category.

Definition 7.11. A continuous map $f: M^m \rightarrow N^n$ between topological manifolds is an *immersion*, denoted $f: M \looparrowright N$, if for every $x \in M$ there is an open neighbourhood $U \ni x$ such that $f|_U$ is an embedding.

Note that an injective immersion is not necessarily an embedding, since an embedding is required to be a homeomorphism onto its image. For example, the exponential map induces an injective and surjective immersion $[0, 1) \rightarrow S^1$ which is not an embedding, since it is not a homeomorphism.

In the smooth category, spaces of immersions are well-understood thanks to the work of Smale and Hirsch [Sma59, Hir59]. Their theory can be used to describe the homotopy type of those spaces in terms of mapping spaces of vector bundles, which are more accessible to the tools of algebraic topology. The following theorem is one consequence of that theory. Let $V_k(\mathbb{R}^n)$ denote the Stiefel space of k -frames in \mathbb{R}^n .

THEOREM 7.12 (Hirsch [Hir59, Thm. 6.1]). *A smooth k -manifold M smoothly immerses into \mathbb{R}^n with $k < n$ if and only if there is a section of the bundle $V_k(\mathbb{R}^n) \rightarrow E \rightarrow M$ associated to the Stiefel bundle $V_k(\mathbb{R}^k) \rightarrow V_k(M) \rightarrow M$ of k -frames in M .*

Let us derive a consequence, which will be used in Section 15.2, and several times thereafter. Recall that a manifold is said to be parallelisable if it has trivial tangent bundle, $TM \cong M \times \mathbb{R}^n$.

COROLLARY 7.13. *Every smooth parallelisable n -manifold admits a smooth immersion into \mathbb{R}^{n+1} .*

Proof. Since $T_k(M) \cong M \times V_k(\mathbb{R}^k)$ is the trivial bundle, any associated bundle has a section. The minimal n allowed by the theorem is $n = k + 1$. \square

This can be improved in case the manifold is open (i.e. each component is noncompact and with empty boundary), or just requiring that each component is not closed (so either open or with non-empty boundary). The crucial property of such manifolds is that they can be deformed into a neighbourhood of their $(n - 1)$ -skeleton.

THEOREM 7.14 (Hirsch [Hir61]). *Every smooth open parallelisable n -manifold admits a smooth immersion into \mathbb{R}^n .*

Part III

Microbundles

Microbundles and topological tangent bundles

Gopal Ananthakrishna, Danica Kosanović, Isacco Nonino, Mark Powell, and Benjamin Matthias Ruppik

We shall provide an answer to the question: what sort of tangent bundles do topological manifolds have? The short answer is: a topological manifold M has a tangent microbundle. Moreover, within the total space of a rank n microbundle, so in particular within the total space of the tangent microbundle of M , there is an \mathbb{R}^n -fibre bundle over M . The main references for this material are Milnor’s paper on microbundles [Mil64] and Kister’s paper “Microbundles are fibre bundles” [Kis64].

Every smooth manifold has a tangent vector bundle $p: TM \rightarrow M$. However, the linear vector bundle transition functions arise from the derivatives of the transition functions between the charts in a smooth atlas, and this a priori does not work for topological manifolds. Our aim is to get an analogue of tangent bundles for topological manifolds: a fibre bundle with structure group $G = \text{Homeo}(\mathbb{R}^n)$, or in fact slightly better, the subgroup of those homeomorphisms of \mathbb{R}^n that fix the origin:

$$G = \text{Homeo}_0(\mathbb{R}^n) := \left\{ f: \mathbb{R}^n \rightarrow \mathbb{R}^n \mid f \text{ is a homeomorphism, } f(\vec{0}) = \vec{0} \right\}.$$

8.1. Microbundles

To find topological tangent bundles, we need to use the notion of microbundles, which is due to Milnor. Microbundles will also be a useful tool in other contexts.

Remark 8.1. For a vector bundle $p: E \rightarrow B$ there is a zero section $z: B \rightarrow E$ with $p \circ z = \text{id}$. Moreover, for every α we have a commutative diagram:

$$\begin{array}{ccccc} & & p^{-1}(U_\alpha) & & \\ & z \nearrow & \uparrow & \searrow p| & \\ U_\alpha & & \varphi_\alpha \cong & & U \\ & \searrow \times 0 & \downarrow & \nearrow \text{pr} & \\ & & U_\alpha \times F & & \end{array}$$

Such a zero section is also defined also for any fibre bundle with fibre \mathbb{R}^n and group $G = \text{Homeo}_0(\mathbb{R}^n)$. On the other hand for such fibre bundles the concept of a sphere or disc bundle is not well-defined.

The idea behind microbundles is to see the fibre at $x \in B$ as the germ of charts over Euclidean neighbourhoods of that point.

Definition 8.2. A *microbundle* \mathfrak{X} of fibre dimension n consists of

- (1) a base space B
- (2) a total space E
- (3) a pair of continuous maps

$$B \xrightarrow{i} E \xrightarrow{j} B$$

such that $j \circ i = \text{Id}_B$ (we call i “the injection” and j “the projection”), and which satisfy *local triviality*: for all $b \in B$, there exist open sets $U \ni b$ and $V \ni i(b)$ and a homeomorphism $V \xrightarrow{\cong} U \times \mathbb{R}^n$, so that $i(U) \subseteq V$, $j(V) \subseteq U$ and the following diagram commutes

$$\begin{array}{ccc} & V & \\ i|_U \nearrow & \downarrow \cong & \searrow j|_V \\ U & & U \\ \text{Id} \times 0 \searrow & U \times \mathbb{R}^n & \nearrow \text{pr}_1 \end{array}$$

Example 8.3. The *standard trivial microbundle* ϵ_B^n of fibre dimension n over a space B . This is given by

$$B \xrightarrow{\times 0} B \times \mathbb{R}^n \xrightarrow{\text{pr}_1} B$$

Taking $U := B$ and $V := B \times \mathbb{R}^n$, we will satisfy the local triviality condition at any $x \in B$.

Example 8.4. We introduce the *underlying microbundle* of an \mathbb{R}^n fibre bundle. If ξ is a fibre bundle $p: E \rightarrow B$ with fibre $F = \mathbb{R}^n$, group $G = \text{Homeo}_0(\mathbb{R}^n)$, and zero section $i: B \rightarrow E$, then $B \xrightarrow{i} E \xrightarrow{j=p} B$ is a microbundle, denoted by $|\xi|$. Indeed, the local triviality is satisfied by charts $V := p^{-1}(U_\alpha) \xrightarrow{\cong} U_\alpha \times \mathbb{R}^n$.

Remark 8.5. There exist non-isomorphic vector bundles with isomorphic underlying microbundles (see Definition 8.7), see [Mil64, Lemma 9.1].

Example 8.6. The key example is the *tangent microbundle* of a topological manifold. If M be a topological manifold, then

$$M \xrightarrow{\Delta} M \times M \xrightarrow{\text{pr}_1} M$$

is a microbundle, called the *tangent microbundle* of M and denoted by \mathfrak{t}_M of M . Here Δ is the diagonal map $m \mapsto (m, m)$, so $\text{pr}_1 \circ \Delta = \text{Id}_M$ is immediate.

To check the local triviality at $x \in M$, let $U \ni x$ and $f: U \xrightarrow{\cong} \mathbb{R}^n$ a chart of M . We define

$$\begin{aligned} h: U \times U &\rightarrow U \times \mathbb{R}^n \\ (u, v) &\mapsto (u, f(v) - f(u)) \end{aligned}$$

Then h is a homeomorphism with inverse $(a, b) \mapsto (a, f^{-1}(b + f(a)))$, and taking $V := U \times U$, gives the desired commutative diagram

$$\begin{array}{ccc} & V & \\ \Delta|_U \nearrow & \downarrow \cong h & \searrow \text{pr}_1 \\ U & & U \\ \times 0 \searrow & U \times \mathbb{R}^n & \nearrow \text{pr} \end{array}$$

This is a bit surprising, as the total space does not seem like a total space of a tangent bundle, since it has too much topology (see Fig. 8.1 for an example). The idea is that we really only have to look at small neighbourhoods of the zero section, not all of the total space $M \times M$.

For a smooth manifold M it is natural to ask about the relationship between the smooth tangent bundle and the tangent microbundle. In order to address this, we introduce the notion of equivalence for microbundles.

Definition 8.7. Two microbundles \mathfrak{X}_1 and \mathfrak{X}_2 over the same base space B are said to be *isomorphic*, written $\mathfrak{X}_1 \cong \mathfrak{X}_2$, if there exist neighbourhoods $E_n \supseteq V_n \supseteq i_n(B)$ for $n = 1, 2$ and a

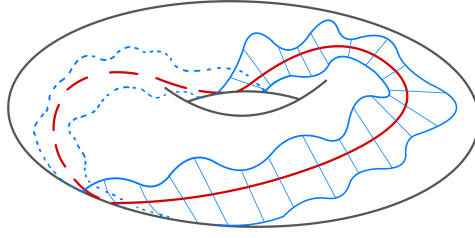

FIGURE 8.1. Tangent microbundle for $M = S^1$.

homeomorphism $V_1 \xrightarrow{\cong} V_2$ such that the following diagram commutes

$$\begin{array}{ccc}
 & V_1 & \\
 i_1 \nearrow & & \searrow j_1|_{V_1} \\
 B & & B \\
 i_2 \searrow & \cong & \nearrow j_2|_{V_2} \\
 & V_2 &
 \end{array}$$

Definition 8.8. A microbundle over B will be called *trivial* if it is isomorphic to the standard trivial microbundle ϵ_B^n (see Example 8.3).

In other words, the total space of a microbundle is not relevant up to isomorphism, only neighbourhoods of $i(B)$ in it. For example, in Fig. 8.1 the blue neighbourhood of $\Delta(S^1) \subseteq S^1 \times S^1$ forms a microbundle over S^1 which is isomorphic to the tangent microbundle \mathfrak{t}_{S^1} . More generally, we have the following theorem.

THEOREM 8.9. *Let M be a smooth manifold with tangent bundle τ_M . Then the underlying microbundle $|\tau_M|$ is isomorphic to the tangent microbundle \mathfrak{t}_M .*

Proof. Choose a Riemannian metric on M . The underlying microbundle $|\tau_M|$ of the tangent bundle is by definition $M \xrightarrow{i} TM \xrightarrow{p} M$, where TM is the total space.

Recall that the exponential map sends $(p, \vec{v}) \in TM$ to $\exp(p, \vec{v}) \in M$ defined as the endpoint of the unique geodesic $\gamma: [0, 1] \rightarrow M$ with $\gamma(0) = p$ and $\gamma'(0) = \vec{v}$. This map is defined in a neighbourhood $E' \supseteq i(M)$ in TM . Then the map

$$h: E' \rightarrow M \times M, \quad (p, \vec{v}) \mapsto (p, \exp(p, \vec{v}))$$

is a local diffeomorphism from a neighbourhood of $(p, 0)$ in TM to neighbourhood of $(p, p) \in M \times M$, thanks to the inverse function theorem.

We claim that the restriction of h on a perhaps smaller neighbourhood $i(M) \subseteq E'' \subseteq E'$ is a homeomorphism onto some neighbourhood $\Delta(M) \subseteq V \subseteq M \times M$. This follows from a point-set topology argument, inductively covering $i(M)$ by open sets on which h is injective. We skip the argument and refer to [Whi61, Lemma 4.1].

Finally, the following diagram commutes by definition

$$\begin{array}{ccc}
 & E'' & \\
 i \nearrow & & \searrow p \\
 M & & M \\
 \Delta \searrow & h & \nearrow \text{pr}_1 \\
 & V &
 \end{array}$$

so we have $|\tau_M| = \mathfrak{t}_M$. □

8.2. Kister's theorem

In this section we prove Kister's theorem [Kis64], which shows that every microbundle on a manifold is isomorphic to the underlying microbundle of an \mathbb{R}^n -fibre bundle (with structure group $\text{Homeo}_0(\mathbb{R}^n)$, see Definition 7.2). In particular, a topological manifold M has the best type of tangent bundle one could hope for: its tangent microbundle \mathfrak{t}_M can be replaced with the so-called *topological tangent bundle*. Throughout this section we fix an integer $n \geq 1$.

THEOREM 8.10 (Kister's Theorem [Kis64]). *Let B be a topological manifold or a locally finite simplicial complex and let $\mathfrak{X} = (B \xrightarrow{i} E \xrightarrow{j} B)$ be a microbundle of rank n . Then there exists $F \subseteq E$ with $i(B) \subseteq F$ such that $F \xrightarrow{j|_F} B$ is an \mathbb{R}^n fibre bundle with $i: B \rightarrow F$ a 0-section and underlying microbundle \mathfrak{X} . Moreover, any two such \mathbb{R}^n -bundles are isomorphic.*

The main ingredient in the proof of this theorem is the following result. Let us denote $\text{Emb}_0^n := \text{Emb}_0(\mathbb{R}^n, \mathbb{R}^n)$ for short and let $i: \text{Homeo}_0(\mathbb{R}^n) \hookrightarrow \text{Emb}_0^n$ be the natural inclusion. Note that a point $g \in \text{Emb}_0^n$ is in the subspace $\text{Homeo}_0(\mathbb{R}^n)$ if and only if g is surjective.

THEOREM 8.11 ([Kis64]). *There is a continuous map $F: \text{Emb}_0^n \times [0, 1] \rightarrow \text{Emb}_0^n$, $F(g, t) = F_t(g)$ such that*

- (1) $F_0 = \text{Id}_{\text{Emb}_0^n}$,
- (2) $\text{Im}(F_1) \subseteq \text{Homeo}_0(\mathbb{R}^n)$,
- (3) $\text{Im}(F_t \circ i) \subseteq \text{Homeo}_0(\mathbb{R}^n)$ for all $t \in [0, 1]$.

Since $F_1 \circ i$ is not required to equal $\text{Id}_{\text{Homeo}_0(\mathbb{R}^n)}$, this is not a deformation retraction. However, the map F does show that the inclusion i is a homotopy equivalence: F_t is a homotopy between $\text{Id}_{\text{Emb}_0^n}$ and $i \circ F_1$, while the map $F_t \circ i$ is a homotopy between $\text{Id}_{\text{Homeo}_0(\mathbb{R}^n)}$ and $F_1 \circ i$.

Here is a warm up lemma before we start the proof of Theorem 8.11, demonstrating how embeddings or homeomorphisms can be deformed in a canonical way, that is continuously.

LEMMA 8.12. *The inclusion $i_0: \text{Homeo}_0(\mathbb{R}^n) \hookrightarrow \text{Homeo}(\mathbb{R}^n)$ is a homotopy equivalence.*

Proof. For $x \in \mathbb{R}^n$ let $t_x: \mathbb{R}^n \rightarrow \mathbb{R}^n$ be the translation $t_x(y) := y + x$. Define the map

$$\Theta: \text{Homeo}(\mathbb{R}^n) \times [0, 1] \rightarrow \text{Homeo}(\mathbb{R}^n), \quad \Theta(g, s) := t_{-sg(0)} \circ g.$$

It is continuous in both variables g and s (see Proposition 7.4). We have $\Theta_0 = \text{Id}$, $\text{Im}(\Theta_1) \subseteq \text{Homeo}_0(\mathbb{R}^n)$, and $\Theta_s \circ i_0 = \text{Id}$ for all $s \in [0, 1]$, so Θ is a (strong) deformation retraction. \square

The proof of the Theorem 8.11 will be significantly harder, but the principle is the same; the key will be the following lemma. Let $D_r \subseteq \mathbb{R}^n$ be the disc of radius r and centre 0.

LEMMA 8.13 (Stretching lemma). *Let $0 \leq a < b$ and $0 < c < d$ and let $g, h \in \text{Emb}_0^n$ be such that $h(\mathbb{R}^n) \subseteq g(\mathbb{R}^n)$ and $h(D_b) \subseteq g(D_c)$. Then there is an isotopy of homeomorphisms $\varphi_t(g, h, a, b, c, d): \mathbb{R}^n \rightarrow \mathbb{R}^n$ for $t \in [0, 1]$, such that*

- (1) $\varphi_0 = \text{Id}_{\mathbb{R}^n}$,
- (2) $\varphi_1(h(D_b)) \supseteq g(D_c)$,
- (3) φ_t fixes $\mathbb{R}^n \setminus g(D_d)$ and $h(D_a)$ pointwise; and
- (4) $\varphi: \text{Emb}_0^n \times \text{Emb}_0^n \times \mathbb{R}^5 \rightarrow \text{Homeo}_0(\mathbb{R}^n)$ with $(g, h, a, b, c, d, t) \mapsto \varphi_t$ is continuous.

Proof. The idea is to expand $h(D_b)$ so it covers $g(D_c)$ in a ‘‘canonical way’’. The naive stretching will be identity on $\mathbb{R}^n \setminus g(D_d)$ but not on $h(D_a)$, so we will first ‘‘push’’ $h(D_a)$ into a ‘‘safe region’’, then do the stretching, and then pull it back out – this is an instance of what is known as a *push-pull* argument.

We work in g -coordinates, which is possible since $h(\mathbb{R}^n)$ is contained in $g(\mathbb{R}^n)$. We will draw g -balls as round and h -balls as crooked, see Fig. 8.2. Moreover, we define:

- $b' :=$ the radius of $g^{-1}h(D_b)$ (in g -coordinates: the radius of the largest disc in $h(D_b)$),

- $a' :=$ the radius of $g^{-1}h(D_a)$ (in g -coordinates: the radius of the largest disc in $h(D_a)$),
- $a'' :=$ the radius of $h^{-1}g(D_{a'})$ (in h -coordinates: the radius of the largest disc contained in $g(D_{a'})$).

Thus, we have $0 \leq a' \leq b' < c < d$ and $0 \leq a'' \leq a < b$. Note that these numbers are defined canonically in terms of g, h and a, b, c, d .

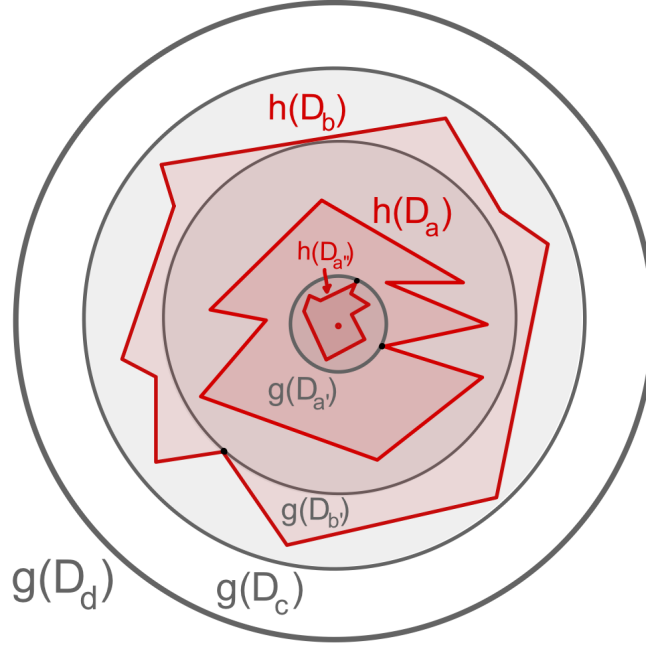

FIGURE 8.2. Nested balls in the stretching lemma, shown in g -coordinates.

First let $\Theta_t(a, b, c, d): \mathbb{R}^n \rightarrow \mathbb{R}^n$ be a stretching isotopy of homeomorphisms of \mathbb{R}^n , defined on all rays from 0 as the piecewise linear function from Fig. 8.3. More precisely, Θ_t is the identity on $[0, a]$ and $[d, \infty)$, sends b to $(1-t)b + tc$, and is extended linearly on $[a, b]$ and $[b, d]$. In particular, $\Theta_0 = \text{Id}$ and Θ_1 stretches D_b over D_c and is fixed on D_a and outside of D_d .

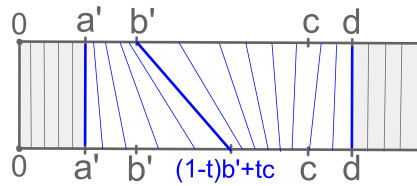

FIGURE 8.3. The stretching function on the positive real line $[0, \infty)$.

To transfer Θ_t to g coordinates we define $\psi_t: \mathbb{R}^n \rightarrow \mathbb{R}^n$ by

$$\psi_t := \begin{cases} g \circ \Theta_t(a', b', c, d) \circ g^{-1}, & \text{on } g(D_d), \\ \text{Id}, & \text{elsewhere.} \end{cases}$$

Thus, ψ_t stretches $g(D_{b'})$ over $g(D_c)$ and $h(D_b)$ over $g(D_c)$. However, ψ_t moves $h(D_a)$, so we now modify it using the push-pull argument as mentioned above. Namely, consider the stretching homeomorphism $\Theta_1(0, a, a'', b)$, which actually look like a contraction since $a'' \leq a$, see Fig. 8.4. Then let

$$\sigma := \begin{cases} h \circ \Theta_1(0, a, a'', b) \circ h^{-1}, & \text{on } h(D_b), \\ \text{Id}, & \text{elsewhere.} \end{cases}$$

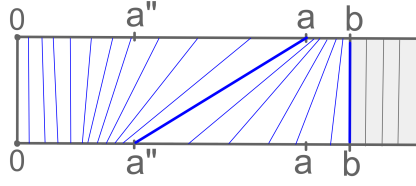

FIGURE 8.4. The map σ applies the depicted map $\Theta_1(0, a, a'', b)$ in h -coordinates.

Finally, for $t \in [0, 1]$ define the desired map by

$$\varphi_t := \sigma^{-1} \circ \psi_t \circ \sigma.$$

This first pushes using σ , then stretches using ψ_t , then pulls back using σ^{-1} . The first three properties in the statement of the lemma are straightforward to check.

It remains to check continuity of φ_t , which, although quite reasonable, requires some work. We will state the following three key propositions, whose proofs can be found in [Kis64].

PROPOSITION 8.14. *Let $g \in \text{Emb}_0^n$ and $r, \varepsilon > 0$. Then there is a $\delta > 0$ so that if $g_1 \in \text{Emb}_0^n$ satisfies $d(g_1|_{D_{r+\varepsilon}}, g|_{D_{r+\varepsilon}}) < \delta$, then*

- (i) $g_1(D_{r+\varepsilon}) \supseteq g(D_r)$,
- (ii) $d(g_1^{-1}|_{g(D_r)}, g^{-1}|_{g(D_r)}) \leq \varepsilon$.

PROPOSITION 8.15. *Let C a compact set, $h: C \rightarrow \mathbb{R}^n$ an embedding, $D \subseteq \mathbb{R}^n$ a compact set containing $h(C)$ in its interior, and $g: D \rightarrow \mathbb{R}^n$ another embedding. For every $\varepsilon > 0$ there is a $\delta > 0$ such that if $g_1: D \rightarrow \mathbb{R}^n$ and $h_1: C \rightarrow \mathbb{R}^n$ are embeddings whose distance from g and h respectively is bounded above by δ , then $g_1 \circ h_1$ is defined and at distance at most ε from $g \circ h$.*

PROPOSITION 8.16. *Let $g, h \in \text{Emb}_0^n$ and $a \geq 0$ such that $h(D_a) \subseteq g(\mathbb{R}^n)$. Let r be the radius of $g^{-1}h(D_a)$. Then $r = r(g, h, a)$ is continuous in the variables g, h and a .*

Now we come back to the proof of continuity of φ_t . We first show that σ is continuous: by Proposition 8.16 a' depends continuously on g, h, a , and a'' depends continuously on h, g, a' , so $\Theta(0, a, a'', b)$ depends continuously on g, h, a, b .

Now σ would be the same function if we slightly modify the domain on which it is possibly not trivial, that is if we set $\sigma = h\Theta_1(0, a, a'', b)h^{-1}$ on $h(D_{b+2})$. Since $h(D_{b+1}) \subseteq \text{Int } h(D_{b+2})$ there is a neighbourhood N of h in Emb_0^n such that $h_1 \in N$ implies $h_1(D_{b+1}) \subseteq h(D_{b+2})$.

Hence, if $h_1 \in N$, $b_1 \in (0, b+1)$ and g_1, a_1 satisfy the hypotheses of the Lemma 8.13, then $\sigma_1 = \sigma(g_1, h_1, a_1, b_1)$ can be defined as $h_1\Theta(0, a_1, a''_1, b_1)h_1^{-1}$ on $h(D_{b+2})$ and 1 everywhere else, where $a''_1 = a'_1 a_1$.

We may assume, using Proposition 8.14, that N has been chosen such that $h_1(D_{b+3}) \supseteq h(D_{b+2})$ for $h_1 \in N$. Hence $h_1^{-1}|_{h(D_{b+2})}$ is defined. Proposition 8.14 also shows that this function varies continuously with h_1 . Using Proposition 8.15, we conclude that $\theta(0, a_1, a''_1, b_1)h_1^{-1}|_{h(D_{b+2})}$ varies continuously with g_1, h_1, a_1 and b_1 . Applying Proposition 8.15 one last time we see that $\sigma_1|_{h(D_{b+2})} = h_1\theta(0, a_1, a''_1, b_1)h_1^{-1}|_{h(D_{b+2})}$ varies continuously with g_1, h_1, a_1, b_1 . Hence, $\sigma(g, h, a, b)$ is continuous.

The proof that ψ_t is continuous is analogous. Since composing embeddings is continuous by Proposition 7.4, we have that ϕ_t is continuous in g, h, a, b, c, d , and t . \square

With Stretching Lemma 8.13 in our pocket, we are ready to prove Theorem 8.11. This will then imply Kister's Main Theorem 8.10.

Proof of Theorem 8.11. For $g \in \text{Emb}_0^n$ we want to define an isotopy $F_t(g) \in \text{Emb}_0^n$ from $g = \text{Id}_{\text{Emb}_0^n}(g)$ and $F_1(g) \in \text{Homeo}_0(\mathbb{R}^n)$. Let $R_g: [0, \infty) \rightarrow [0, \infty)$ be the piecewise linear function

such that $R_g(0) = 0$ and $R_g(i)$ for $i \in \mathbb{N}$ is the radius of the largest disc inside $g(D_i)$. We apply R_g on rays from the origin in \mathbb{R}^n , that is:

$$h_g: \mathbb{R}^n \rightarrow \mathbb{R}^n, \quad h_g(r, \theta) := (R_g(r), \theta).$$

Note that $h_g(\mathbb{R}^n) \subseteq g(\mathbb{R}^n)$ is a round open disc, and $h_g(D_i) \subseteq g(D_i)$ for all $i \in \mathbb{N}_0$. Moreover, h_g is continuous in g , since it depends only on the radius function R_g , and this depends continuously on g by Proposition 8.16.

The idea of the proof is to first isotope g to an embedding $F_{1/2}(g)$ whose image is $h_g(\mathbb{R}^n)$, and then expand this open disc in a uniform way to an embedding $F_1(g)$ whose image is all of \mathbb{R}^n .

Step 1. Perform an isotopy from g to an embedding whose image is the open disc $h_g(\mathbb{R}^n)$. To achieve this, we will define an isotopy $\alpha_t^g: \mathbb{R}^n \rightarrow g(\mathbb{R}^n)$ such that

- (1) $\alpha_0^g = h_g$;
- (2) $\alpha_1^g(\mathbb{R}^n) = g(\mathbb{R}^n)$;
- (3) α_t^g is continuous in g and t .

We apply Lemma 8.13 for $g, h = h_g$ and $a = 0, b = c = 1, d = 2$, to obtain the stretching isotopy φ_t . Then for $t \in [0, 1/2]$ define

$$\alpha_t^g := \varphi_{2t} \circ h_g.$$

We see that $\alpha_0^g = h_g, g(D_1) \subseteq \alpha_{1/2}^g(D_1)$, and $\alpha_{1/2}^g(D_2) \subseteq g(D_2)$.

Now we consider the interval $[1/2, 3/4]$. Again by Lemma 8.13 applied to $g, h = \alpha_{1/2}^g$, and $a = 1, b = c = 2, d = 3$, we obtain a new isotopy φ_t . Then for $t \in [1/2, 3/4]$ define

$$\alpha_t^g := \varphi_{4t-2} \circ \alpha_{1/2}^g.$$

We have $\alpha_{1/2}^g$ same as above, $g(D_2) \subseteq \alpha_{3/4}^g(D_2)$, and $\alpha_{3/4}^g(D_3) \subseteq g(D_3)$. Moreover, $\alpha_t^g|_{D_1} = \alpha_{1/2}^g|_{D_1}$ for all $t \in [1/2, 3/4]$.

Now continue this procedure, considering for each $n \in \mathbb{N}$ the interval $[1 - 1/2^n, 1 - 1/2^{n-1}]$. To make sure that the limit function α_1 is defined, we need the following proposition; again, the proof can be found in [Kis64].

PROPOSITION 8.17. *If $\alpha: \text{Emb}_0^n \times [0, 1) \rightarrow \text{Emb}_0^n$ is continuous and for all $t \in [1 - (1/2)^n, 1)$ and $n \geq 1$ satisfies $\alpha_t(g)|_{D_n} = \alpha_{1-(1/2)^n}(g)|_{D_n}$, then α can be extended to $\text{Emb}_0^n \times I$.*

Applying Proposition 12.8 to our α_t^g gives α_1^g such that $\alpha_1^g(\mathbb{R}^n) = g(\mathbb{R}^n)$. Then for $t \in [0, 1/2]$ we define

$$F_t(g) := \alpha_{1-2t}^g \circ (\alpha_1^g)^{-1} \circ g$$

Note that at $F_0(g) = g$ and $F_{1/2}(g) = h \circ (\alpha_1^g)^{-1} \circ g$ has image $F_{1/2}(g)(\mathbb{R}^n) = h_g(\mathbb{R}^n)$. We now expand this open disc to the whole of \mathbb{R}^n .

Step 2: Perform a concatenation of piecewise linear isotopies moving h_g to $\text{Id}_{\mathbb{R}^n}$. To do this, we define an isotopy $\beta_t^g: \mathbb{R}^n \rightarrow \mathbb{R}^n$ such that

- (1) $\beta_0^g = h_g$;
- (2) $\beta_1^g = \text{Id}$; and
- (3) β_t^g is continuous in g and t .

This is quite similar to what we have done before, but easier since Lemma 8.13 is now not needed. Define h_g on rays from the origin as before. For time $[0, 1/2]$ move $R_g(1)$ to 1 by an isotopy of piecewise linear functions, as in Fliure 8.5a.

That is, for $s \in [0, 1]$ let $\theta_s(R_g(1)) = (1 - s)R_g(1) + s$, and extend linearly in $[0, R_g(1)]$ and $[R_g(1), \infty)$. Then for $t \in [0, 1/2]$ define

$$\beta_t^g = \theta_{2t} \circ h.$$

In $[1/2, 3/4]$ move $R_g(2)$ to 2 in a similar fashion, while fixing $[0, 1]$, as in Fig. 8.5b. Then continue in the same way for all positive integers, defining an isotopy β_t^g for all $t \in [0, 1]$ analogously to the definition of α_t^g above, so that $\beta_1^g = \text{Id}$ (again one must check that the isotopy is continuous at $t = 1$).

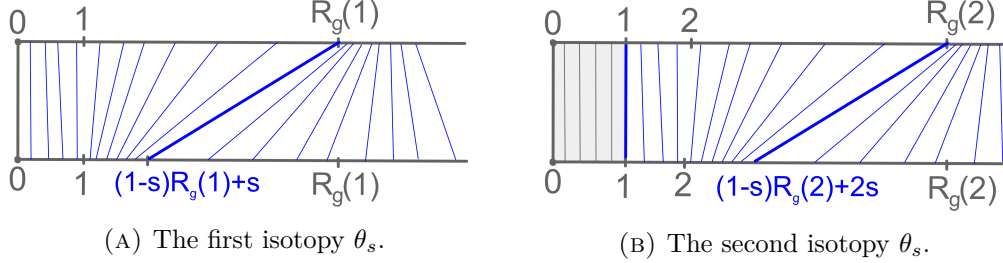

FIGURE 8.5

Now we can define the second half of F by

$$F_t(g) := \begin{cases} \alpha_{1-2t}^g \circ (\alpha_1^g)^{-1} \circ g & t \in [0, 1/2] \\ \beta_{2t-1}^g \circ (\alpha_1^g)^{-1} \circ g & t \in [1/2, 1] \end{cases}$$

At $t = 1/2$, we have $\beta_0^g = h$ so that $h_g \circ (\alpha_1^g)^{-1} \circ g = \alpha_0^g \circ (\alpha_1^g)^{-1} \circ g$, so the composite function is continuous at $1/2$. We also know that $\beta_1^g = \text{Id}$ so that at $t = 1$ we have $(\alpha_1^g)^{-1} \circ g$. Since $\alpha_1^g(\mathbb{R}^n) = g(\mathbb{R}^n)$, $(\alpha_1^g)^{-1} \circ g$ is a homeomorphism.

One needs to check that F is indeed continuous in g and t . We also note that if g is a homeomorphism, then $F_t(g)$ is a homeomorphism for every t , by inspecting the proof. \square

Now we can use this result to prove Kister's Theorem 8.10: microbundles contain \mathbb{R}^n -fibre bundles. More precisely, if B a locally finite simplicial complex or a topological manifold and $\mathfrak{X} = B \xrightarrow{i} E \xrightarrow{j} B$ is a microbundle, we want to prove there is an open set $E_1 \subseteq E$ containing $i(B)$ such that $j|_{E_1}: E_1 \rightarrow B$ is a fibre bundle with $\text{Homeo}_0(\mathbb{R}^n)$ as structure group. We call such a bundle an *admissible bundle* for \mathfrak{X} .

Proof of Theorem 8.10. The strategy of the proof is as follows.

- (i) Prove the theorem for a locally finite simplicial complex B by induction on simplices.
- (ii) Deduce for $M = B$ a topological manifold.

For the second item, although M is in general not a simplicial complex, it is an Euclidean neighbourhood retracts, i.e. there is an open neighbourhood $M \subseteq V \subseteq \mathbb{R}^N$ with a retraction $r: V \rightarrow M$ see Theorem 3.3. Then $r^*\mathfrak{X}$ is a microbundle on V of the same rank, and since V is an open subset of \mathbb{R}^N , it admits a smooth structure. In particular, V admits a locally finite triangulation, so we can apply (i) to obtain an admissible fibre bundle ξ inside $E(r^*\mathfrak{X})$. The restriction of ξ along the inclusion $i: M \hookrightarrow V$ gives the desired \mathbb{R}^n -fibre bundle $i^*\xi$ over M with

$$E(i^*\xi) \subseteq E(i^*r^*(\mathfrak{X})) = E((r \circ i)^*\mathfrak{X}) = E(\text{Id}^*\mathfrak{X}) = E(\mathfrak{X}).$$

Now, to prove (i) we induct both on simplices and on the dimension m of the simplicial complex. For each m we consider the following two statements, for microbundles of a fixed rank n .

$X_m :=$ "Every microbundle over a locally finite m -dim. simplicial complex admits a bundle."

$U_m :=$ "Any two such admissible bundles for such a microbundle are isomorphic."

Both X_0 and U_0 hold since every microbundle over a point is trivial, and therefore the same holds over a collection of 0-simplices with the discrete topology. For the induction step we prove that X_{m-1} and U_{m-1} together imply X_m , and that X_m implies U_m .

Let us show the first claim. Let K be a locally finite simplicial complex with a microbundle

$$\mathfrak{X} = K \xrightarrow{i} E \xrightarrow{j} K$$

Let K' denote the $(m-1)$ -skeleton of K and pick an m -simplex σ of K not in K' .

Since σ is contractible, it admits a trivial admissible bundle ξ_σ , and homeomorphism h_σ fitting into the diagram:

$$\begin{array}{ccc} & \sigma & \\ \times 0 \swarrow & & \searrow i \\ \sigma \times \mathbb{R}^n & \xrightarrow[h_\sigma \cong]{} & E(\xi_\sigma) \\ \text{pr}_1 \searrow & & \swarrow j| \\ & \sigma & \end{array}$$

Let D be an open set in E such that $i(K) \subseteq D$ and

$$j^{-1}(\sigma) \cap D \subseteq E(\xi_\sigma).$$

Then consider the following restriction of \mathfrak{X} to K' :

$$\mathfrak{X}' = \{K' \xrightarrow{i'} j^{-1}(\sigma) \cap D \xrightarrow{j'} K'\}$$

By X_{m-1} we know that \mathfrak{X}' admits an \mathbb{R}^n -bundle η over K' . In order to now glue η and ξ_σ we have to make them compatible along the collar of the boundary $\partial\sigma$. Note that since ξ_σ is trivial, $\xi|_{\partial\sigma}$ is a trivial fibre bundle. But now $\eta|_{\partial\sigma}$ and $\xi|_{\partial\sigma}$ are admissible bundles for the same microbundle, so by U_{m-1} they are isomorphic. In particular, $\eta|_{\partial\sigma}$ is also trivial and we have a homeomorphism h_η fitting into the diagram:

$$\begin{array}{ccc} & \partial\sigma & \\ \times 0 \swarrow & & \searrow i \\ \partial\sigma \times \mathbb{R}^n & \xrightarrow[h_\eta \cong]{} & E(\eta|_{\partial\sigma}) \\ \text{pr}_1 \searrow & & \swarrow j| \\ & \partial\sigma & \end{array}$$

Thus, over $\partial\sigma$ we have two trivialisations h_σ and h_η , and we can consider $h_\sigma^{-1}h_\eta$, which is a fibrewise embedding of a fibre of η into a fibre of ξ over $\partial\sigma$. For every $p \in \partial\sigma$ we thus define $g^p: \mathbb{R}^n \rightarrow \mathbb{R}^n$ with $g^p \in \text{Emb}_0^n$ by the formula

$$h_\sigma^{-1} \circ h_\eta(p, q) = (p, g^p(q)).$$

Now, let σ_1 be a smaller m -simplex in σ , and as in Fig. 8.6 identify $\sigma \setminus \text{Int } \sigma_1 \cong \partial\sigma \times [0, 1]$ so that $\partial\sigma = \partial\sigma \times \{0\}$ and $\partial\sigma_1 = \partial\sigma \times \{1\}$.

We now use the map $F: \text{Emb}_0^n \times I \rightarrow \text{Emb}_0^n$ constructed in Theorem 8.11. For brevity, for each $(p, t) \in \partial\sigma \times I$, we write $g_t^p := F(g^p, t): \mathbb{R}^n \rightarrow \mathbb{R}^n$. At $t = 0$ this is the embedding $g_0^p = g^p$, while at $t = 1$ it is a homeomorphism.

Consider the space

$$E_1 := E(\eta) \cup \left\{ h_\sigma((p, t), g_t^p(q)) \mid (p, t) \in \partial\sigma \times I \cong \sigma \setminus \text{Int } \sigma_1, q \in \mathbb{R}^n \right\} \cup E(\xi_\sigma|_{\sigma_1})$$

To complete the proof of X_m it remains to show that the projection

$$j|_{E_1}: E_1 \rightarrow K' \cup \sigma$$

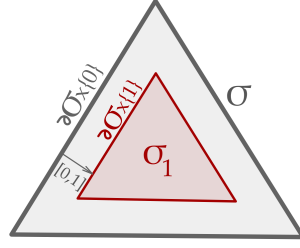

FIGURE 8.6. A parametrisation $\partial\sigma \times [0, 1]$ of the grey region $\sigma \setminus \sigma_1$ between the two simplices.

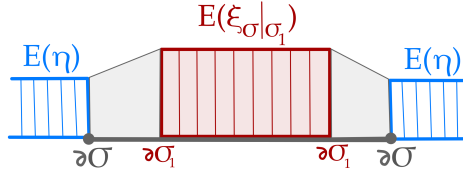

FIGURE 8.7. We define the bundle E_1 by gluing the two bundles over simplices σ and σ_1 , together with a transition in the region $\sigma \setminus \sigma_1$ given by Kister's isotopy.

is indeed a fibre bundle (so that it is an admissible bundle for $\mathfrak{X}|_{K' \cup \sigma}$). The idea is that as $t \in [0, 1]$ increases, the image of $h_\sigma((p, t), g_t^p(q))$ expands. Since g_1^p is a homeomorphism, for each $p \in \partial\sigma$ the image fills up the entire fibre $\xi_\sigma|_{\partial\sigma \times \{1\}} = \xi_\sigma|_{\partial\sigma_1}$.

We define a trivialisaton over $\sigma \setminus \text{Int } \sigma_1$ by

$$f: (\sigma \setminus \text{Int } \sigma_1) \times \mathbb{R}^n \rightarrow E_1$$

$$((p, t), q) \mapsto h_\sigma((p, t), g_t^p(q)).$$

On the other hand, for $(p, 1) \in \partial\sigma \times \{1\} = \partial\sigma_1$ we have $e^p \in \text{Homeo}_0(\mathbb{R}^n)$ given by

$$e^p(q) = \text{pr}_2 \circ f^{-1} h_\sigma((p, 1), q).$$

Then we can let

$$e: \sigma \times \mathbb{R}^n \rightarrow j^{-1}(\sigma) \cap E_1$$

$$e((p, t), q) = \begin{cases} h_\sigma((p, t), q), & (p, t) \in \sigma_1, \\ f((p, t), e^p(q)), & (p, t) \in \sigma \setminus \text{Int } \sigma_1. \end{cases}$$

Since $f^{-1} h_\sigma((p, 1), q) = ((p, 1), e^p(q))$, we have for all $p \in \partial\sigma$ and $q \in \mathbb{R}^n$ that

$$h_\sigma((p, 1), q) = f((p, 1), e^p(q)).$$

Therefore, e is a well-defined homeomorphism, and a local trivialisaton of $j|_{E_1}$ over $\text{Int } \sigma$.

We also need to show that $j|_{E_1}$ is locally trivial over $\partial\sigma$, and also that X_m implies U_m . These are rather similar in spirit to the proofs we have just done, so we omit them, referring to [Kis64] for details. \square

EXERCISE 8.1. (PS4.1) Every microbundle over a paracompact contractible space B is isomorphic to the trivial microbundle over B .

EXERCISE 8.2. (PS4.3) For X compact and Y a metric space, the compact-open topology on $\mathcal{C}(X, Y) := \{f: X \rightarrow Y \mid f \text{ continuous}\}$ coincides with the uniform topology coming from

$$d(f, g) := \sup_{x \in X} d_Y(f(x), g(x)).$$

EXERCISE 8.3. (PS5.1) Let X and Y be compact metric spaces with $X \times \mathbb{R}$ homeomorphic to $Y \times \mathbb{R}$. Then $X \times S^1$ is homeomorphic to $Y \times S^1$.

Hint: let $h: X \times \mathbb{R} \rightarrow Y \times \mathbb{R}$ be a homeomorphism, and consider the two product structures on $Y \times \mathbb{R}$, the intrinsic one and the one coming from $h(X \times \mathbb{R})$. Use a push-pull construction (repeated infinitely many times) to create a periodic homeomorphism $H: X \times \mathbb{R} \rightarrow Y \times \mathbb{R}$, i.e. for some $p \in \mathbb{R}$, $H(x, t) = H(x, t + p)$ for all $t \in \mathbb{R}$, $x \in X$.

Normal microbundles and smoothing of a manifold crossed with Euclidean space

Mark Powell

We want to prove the following theorem, which is the start of smoothing theory. It gives a criterion in terms of microbundles under which, for a topological manifold M , there is a smooth structure on $M \times \mathbb{R}^q$ for some $q \geq 0$.

THEOREM 9.1. *Let M be a topological manifold. Then $M \times \mathbb{R}^q$ admits a smooth structure for some q if and only if \mathfrak{t}_M is stably isomorphic to $|\xi|$ for some vector bundle ξ over M .*

In order to prove this, we will need some more of the theory of microbundles, especially the notion of a normal microbundle to a locally flat embedding. Note that a locally flat embedding need not admit a normal microbundle.

9.1. Constructions of microbundles

Let $\mathfrak{X} = \{B \xrightarrow{i} E \xrightarrow{j} B\}$ be a microbundle.

Definition 9.2 (Restriction). Define the *restricted microbundle* for a subset $A \subseteq B$, by

$$\mathfrak{X}|_A = \{A \xrightarrow{i|_A} j^{-1}(A) \xrightarrow{j|_{j^{-1}(A)}} A\}.$$

Restricted microbundle is a special case of the following construction (when f is an inclusion).

Definition 9.3 (Pullback). Given a map $f: A \rightarrow B$ we define the *pullback microbundle*

$$f^*\mathfrak{X} := \{A \xrightarrow{i'} E' \xrightarrow{\text{pr}_1} A\}$$

where $E' = \{(a, e) \in A \times E \mid f(a) = j(e)\}$ is the pullback and the map $i': A \rightarrow E'$ is given by $i'(a) = (a, i \circ f(a))$.

In other words, the following diagram commutes

$$\begin{array}{ccccc}
 A & & & & \\
 & \searrow^{i'} & & \searrow^{i \circ f} & \\
 & & E' & \xrightarrow{\text{pr}_2} & E \\
 & \searrow^{\text{Id}} & \downarrow \text{pr}_1 & & \downarrow j \\
 & & A & \xrightarrow{f} & B
 \end{array}$$

THEOREM 9.4. *If A is paracompact, $\mathfrak{X} = \{B \rightarrow E \rightarrow B\}$ a microbundle, and $f, g: A \rightarrow B$ are homotopic, $f \simeq g$, then the two pullbacks $f^*\mathfrak{X} \cong g^*\mathfrak{X}$ are isomorphic.*

We refer the reader to Milnor's paper [Mil64, Theorem 3.1 & Section 6] for the proof. This theorem is important, as we shall use it several times, in particular to see (via an exercise on the problem sheets) that a microbundle over a contractible space is trivial.

Definition 9.5 (Whitney sums). Given two microbundles $\mathfrak{X}_1, \mathfrak{X}_2$ over the same base B , their *Whitney sum* is the microbundle $\mathfrak{X}_1 \oplus \mathfrak{X}_2 := \{B \xrightarrow{i_1 \times i_2} E(\mathfrak{X}_1 \oplus \mathfrak{X}_2) \xrightarrow{p} B\}$, using the pullback

$$\begin{array}{ccccc}
 B & & & & \\
 \downarrow i_1 & \searrow i_1 \times i_2 & & \nearrow i_2 & \\
 & E(\mathfrak{X}_1 \oplus \mathfrak{X}_2) & \longrightarrow & E(\mathfrak{X}_2) & \\
 & \downarrow & & \downarrow j_2 & \\
 & E(\mathfrak{X}_1) & \xrightarrow{j_1} & B & \\
 & & & & \uparrow j_2 \\
 & & & & B
 \end{array}$$

where the two dotted maps are canonical maps $i_1 \times i_2 = (i_1(b), i_2(b))$ and $p(e_1, e_2) = j_1(e_1) = j_2(e_2)$.

Definition 9.6 (Cartesian product). Given two microbundles $\mathfrak{X}_1, \mathfrak{X}_2$ over possibly distinct base spaces $B(\mathfrak{X}_1)$ and $B(\mathfrak{X}_2)$, we define the *product microbundle* $\mathfrak{X}_1 \times \mathfrak{X}_2$ by

$$B(\mathfrak{X}_1) \times B(\mathfrak{X}_2) \xrightarrow{i_1 \times i_2} E(\mathfrak{X}_1) \times E(\mathfrak{X}_2) \xrightarrow{j_1 \times j_2} B(\mathfrak{X}_1) \times B(\mathfrak{X}_2)$$

Remark 9.7. With these definitions, the Whitney sum of two microbundles over the same base is the same as the pullback $\Delta^*(\mathfrak{X}_1 \times \mathfrak{X}_2)$ of the product, along the diagonal $\Delta: B \rightarrow B \times B$.

LEMMA 9.8. *The tangent microbundle of a product $\mathfrak{t}_{M \times N}$ is isomorphic to the product of tangent microbundles $\mathfrak{t}_M \times \mathfrak{t}_N$.*

Proof. In the following diagram, the outside vertical maps are the identity maps, and the middle vertical map permutes the coordinates as appropriate to make the diagram commute.

$$\begin{array}{ccccc}
 M \times N & \xrightarrow{\Delta_{M \times N}} & M \times N \times M \times N & \xrightarrow{\text{pr}_{1,2}} & M \times N \\
 \text{Id} \uparrow & & \uparrow & & \text{Id} \uparrow \\
 M \times N & \xrightarrow{\Delta_M \times \Delta_N} & M \times M \times N \times N & \xrightarrow{\text{pr}_{1,3}} & M \times N
 \end{array}$$

The top row describes $\mathfrak{t}_{M \times N}$, while the bottom row describes $\mathfrak{t}_M \times \mathfrak{t}_N$. Since the middle map is a homeomorphism, the two microbundles are isomorphic. \square

Recall that \mathfrak{e}_B^n denotes the standard trivial microbundle of fibre dimension n over B .

Definition 9.9. Two microbundles $\mathfrak{X}, \mathfrak{X}'$ over B are *stably isomorphic* if

$$\mathfrak{X} \oplus \mathfrak{e}_B^q \cong \mathfrak{X}' \oplus \mathfrak{e}_B^r$$

for some $q, r \geq 0$. We denote the stable isomorphism class of \mathfrak{X} by $[\mathfrak{X}]$ and define the operation

$$[\mathfrak{X}] + [\mathfrak{X}'] := [\mathfrak{X} \oplus \mathfrak{X}'].$$

Since Whitney sum is commutative and associative, this operation makes the set of stable isomorphism classes of microbundles over B into a commutative monoid, with $[\mathfrak{e}_B^n]$ as the unit. Thanks to the following theorem, if B is a manifold then all elements have inverses.

THEOREM 9.10. *Let B be a manifold or finite CW complex. Let \mathfrak{X} be a microbundle over B . Then there exists a microbundle η over B such that $\mathfrak{X} \oplus \eta$ is trivial.*

For the proof see [Mil64, Theorem 4.1].

Definition 9.11. Denote the abelian group of microbundles with base B a manifold or finite CW complex, up to stable isomorphism, with Whitney sum as the group operation, by $k_{\text{TOP}}(B)$.

9.2. Normal microbundles

Definition 9.12 (Normal microbundle). Let $M^m \subseteq N^n$ be a submanifold. We say that M has a *microbundle neighbourhood* in N if there exists a neighbourhood $U \supseteq M$ and a retraction $j: U \rightarrow M$ such that

$$M \xrightarrow{\text{incl}} U \xrightarrow{j} M$$

is a microbundle. We call it a *normal microbundle* $\mathfrak{n}_{M \hookrightarrow N}$ of M in N .

Remark 9.13. If M has a normal microbundle, then M is locally flat. This is superfluous, since we actually defined a submanifold as being locally flat. However, it is worth emphasising, since the converse is false in general, i.e. locally flat submanifolds need not have normal microbundles. This is somewhat unfortunate, but will turn out to be manageable.

Note that the situation is special in codimensions 1 and 2, where it is known that locally flat embeddings admit normal microbundles. In fact they admit normal bundles in these codimensions.

Milnor [Mil64, Theorem 5.8] proved that for every embedding $M \subseteq N$, there is an integer q such that the composition $M \rightarrow N \rightarrow N \times \mathbb{R}^q$ admits a normal microbundle. Stern improved this later with quantitative bounds as follows. Intermediate results were also proven by Hirsch, but Stern's bounds seem to be the best known.

THEOREM 9.14 (Stern, [Ste75, Theorem 4.5]). *Let $M^m \subseteq N^n$ be a submanifold of codimension $q = n - m$ and pick $j \in \{0, 1, 2\}$.*

- (1) *If $m \leq q + 1 + j$ and $q \geq 5 + j$, then there exists a normal microbundle.*
- (2) *Any two normal microbundles \mathfrak{n} and \mathfrak{n}' for M are isomorphic if $m \leq q + j$.*

In particular, for all submanifolds $M \subseteq N$, $M \subseteq N \times \{0\} \subseteq N \times \mathbb{R}^q$ admits an essentially unique normal microbundle for some $q \gg 0$.

Our short term goal is to use microbundles to give a description of when for a given manifold M , the product $M \times \mathbb{R}^q$ admits a smooth structure for some q . For this we need to develop more theory of normal microbundles.

LEMMA 9.15. *Every trivial microbundle is isomorphic to the trivial \mathbb{R}^n -fibre bundle. More precisely, if $\mathfrak{X} = \{B \rightarrow E \rightarrow B\}$ is isomorphic to the trivial microbundle over B of rank n , over a paracompact space B , then there exists $U \subseteq E$ with $U \cong B \times \mathbb{R}^n$ such that the following diagram commutes*

$$\begin{array}{ccccc} & & B \times \mathbb{R}^n \cong U & & \\ & \nearrow \times 0 & \downarrow & \searrow \text{pr}_1 & \\ B & \longrightarrow & E & \longrightarrow & B. \end{array}$$

To prove this one observes that E can be assumed to be an open subset of $B \times \mathbb{R}^n$ and then rescales this, see [Mil64, Lemma 2.3]. We apply this to the case when a normal microbundle is trivial, obtaining a criterion under which we can find an actual product neighbourhood.

COROLLARY 9.16. *Suppose $M^m \subseteq N^n$ admits a trivial normal microbundle. Then M is flat, that is there exists an embedding $M \times \mathbb{R}^{n-m} \hookrightarrow N$ with $(x, 0) \mapsto x$ for all $x \in M$.*

One can ask to what extent is a normal microbundle unique.

THEOREM 9.17. *Assume $M^m \subseteq N^n$ is a submanifold which has a normal microbundle. Then*

$$\mathfrak{t}_M \oplus \mathfrak{n}_{M \hookrightarrow N} \cong \mathfrak{t}_N|_M$$

Recall that Theorem 9.10 states that $k_{TOP}(M)$ is a group, namely that any microbundle over a finite CW complex B has a stable inverse. We can now show this for manifolds.

Proof of Theorem 9.10 for B a manifold. Consider an embedding $M \subseteq \mathbb{R}^d$ for some d . By Theorem 9.14, by possibly increasing d , M has a normal microbundle $\mathbf{n}_{M \hookrightarrow \mathbb{R}^d}$. By Theorem 9.17 we have

$$\mathbf{t}_M \oplus \mathbf{n}_{M \hookrightarrow \mathbb{R}^d} \cong \mathbf{t}_{\mathbb{R}^d}|_M \cong \mathbf{e}_M^d,$$

so $[\mathbf{t}_M]$ has a stable inverse. \square

COROLLARY 9.18. *Let $M \subseteq N$ be a submanifold. Then $[\mathbf{t}_M] = [i^*\mathbf{t}_N]$ if and only if there exists $q > 0$ such that $M = M \times \{0\} \subseteq N \times \mathbb{R}^q$ has a product neighbourhood $M \times \mathbb{R}^q$.*

Proof. By Theorem 9.17, we have $[\mathbf{t}_M] + [\mathbf{n}_{M \hookrightarrow N}] \cong [\mathbf{t}_N|_M] \cong [i^*\mathbf{t}_N] \cong [\mathbf{t}_M]$. Now we can subtract these classes to obtain $[\mathbf{n}_{M \hookrightarrow N}] \cong [\mathbf{e}_M]$. Hence, by Corollary 9.16 the submanifold $M \times \{0\} \subseteq N \times \mathbb{R}^q$ has a product neighbourhood for some large q . \square

Normal microbundles will also be useful in connection with topological transversality for submanifolds.

9.3. Precursor to smoothing theory

The following theorem is a preliminary step towards answering the question of when topological manifolds admit smooth structures.

THEOREM 9.19. *Let M be a topological manifold. Then $M \times \mathbb{R}^q$ admits a smooth structure for some q if and only if \mathbf{t}_M is stably isomorphic to $|\xi|$ for some vector bundle ξ over M .*

Proof. Suppose that $M \times \mathbb{R}^q$ admits a smooth structure for some q . We have the following sequence of isomorphisms of microbundles

$$|\tau_{M \times \mathbb{R}^q}| \cong \mathbf{t}_{M \times \mathbb{R}^q} \cong \mathbf{t}_M \times \mathbf{t}_{\mathbb{R}^q} \cong \mathbf{t}_M \times \mathbf{e}_{\mathbb{R}^q}^q.$$

For the first isomorphism we used Theorem 8.9, while the second is by Lemma 9.8. The third holds because the tangent microbundle of \mathbb{R}^n is trivial. Restricting to $M \times \{0\}$ we have

$$|\tau_{M \times \mathbb{R}^q}|_{M \times \{0\}} \cong (\mathbf{t}_M \times \mathbf{e}_{\mathbb{R}^q}^q)|_{M \times \{0\}} \cong \mathbf{t}_M \oplus \mathbf{e}_M^q,$$

where the final isomorphism follows from the commutative diagram

$$\begin{array}{ccccc} M \times \mathbb{R}^q & \xrightarrow{\Delta_M \times \Delta_{\mathbb{R}^d}} & M \times M \times \mathbb{R}^q \times \mathbb{R}^q & \xrightarrow{pr_{1,3}} & M \times \mathbb{R}^q \\ \text{Id} \times 0 \uparrow & & \text{Id} \times \text{Id} \times 0 \times \text{Id} \uparrow & & \text{Id} \times 0 \uparrow \\ M & \xrightarrow{\Delta_M \times 0} & M \times M \times \mathbb{R}^q & \xrightarrow{pr_1} & M \end{array}$$

Namely, the top row describes the product $\mathbf{t}_M \times \mathbf{e}_{\mathbb{R}^q}^q$, and by definition its restriction to $M \times \{0\}$ is obtained by precomposing with $\text{Id} \times 0$ and restricting $p_{1,3}$ to the image of $\text{Id} \times 0$. But this agrees with the bottom row, which is precisely the microbundle $\mathbf{t}_M \oplus \mathbf{e}_M^q$ over M .

Therefore, \mathbf{t}_M is stably isomorphic to the underlying microbundle of the smooth bundle $\tau_{M \times \mathbb{R}^q}|_{M \times \{0\}}$ (since restriction commutes with taking underlying microbundles). This completes the proof of the forwards direction.

Now for the converse, assume that $[\mathbf{t}_M] = [|\xi|]$ for some smooth vector bundle ξ over M . Since topological manifolds are Euclidean Neighbourhood Retracts, there is an embedding $M \subseteq V \subseteq \mathbb{R}^k$ and a retraction $r: V \rightarrow M$ where V is open.

Therefore, ξ extends to a vector bundle $\xi' = r^*\xi$ over V . Since V is a smooth manifold and $BO(k)$ is an infinite union of finite dimensional smooth manifolds given by Grassmannians $\text{Gr}_k(\mathbb{R}^q)$, by finite dimensionality of V we can approximate the classifying map $V \rightarrow BO(k)$ of ξ' by a map into a smooth manifold $\text{Gr}_k(\mathbb{R}^q)$ for some q . In other words, we can assume ξ' is a smooth vector bundle, so that the total space $E(\xi')$ is a smooth manifold. Now $V \hookrightarrow E(\xi')$ and

$$\tau_V \oplus \xi' \cong \tau_{E(\xi')}|_V.$$

Since $V \subseteq \mathbb{R}^k$ is open and a restriction of a trivial bundle $\tau_{\mathbb{R}^k} \cong \mathcal{E}^k$ is also trivial, we have that $\tau_V \cong \mathcal{E}^k$. Hence, restricting to M gives

$$\mathcal{E}^k \oplus \xi \cong \tau_E|_M$$

and therefore for the underlying microbundles

$$|\mathcal{E}^k| \oplus |\xi| \cong \mathfrak{t}_E|_M.$$

By assumption $|\xi|$ is stably isomorphic to \mathfrak{t}_M , so $\mathfrak{t}_E|_M$ is also stably isomorphic to \mathfrak{t}_M .

From Corollary 9.18 it follows that $M \times \{0\} \subseteq E \times \mathbb{R}^s$ has a product neighbourhood, that is $M \times \mathbb{R}^q \subseteq E \times \mathbb{R}^s$ is an open subset of a smooth manifold. Therefore it has a smooth structure obtained from pulling back the smooth structure on $E \times \mathbb{R}^s$ as in Proposition 9.20 below. \square

PROPOSITION 9.20. *Let $U \subseteq M$ be a topological manifold embedded as an open subset of a smooth manifold. Then U admits a smooth structure.*

Proof. Choose a collection of charts for M that cover U , $\{V_\alpha\}$. Refine the cover so that all the intersections $\{V_\alpha \cap U\}$ are again charts, homeomorphic to \mathbb{R}^n . This is possible as we can choose small open balls around every point contained in U , and restrictions of homeomorphisms are homeomorphisms. Note that since U is open this is a collection of open subsets.

Then the transition functions of $\{V_\alpha \cap U\}$ are restrictions of the transition functions for the V_α , so they are again smooth. The maximal smooth atlas containing $\{V_\alpha \cap U\}$ is a smooth structure on U . \square

Remark 9.21. If we can show that \mathfrak{t}_M is stably isomorphic to $|\xi|$ for some smooth vector bundle ξ over M , can we get a smooth structure on M ? We could ask a similar question in the PL category, assuming we had a good definition of a PL bundle. There is such a definition, but we will not introduce it here. We now know from Theorem 9.19 that one can find a smooth structure for $M \times \mathbb{R}^q$ for some $q \geq 0$.

The work of Kirby and Siebenmann, which we will study soon, shows that, for manifolds of dimension at least 5, one can improve a smooth or PL structure on $M \times \mathbb{R}$ to a smooth structure on M . So in fact the result we have just proven will be extremely useful, since it is the starting point for actually finding a smooth or PL structure on M itself.

Kirby and Siebenmann's results, when combined with the results of surgery theory, will also allow us to compute the number of distinct smooth or PL structures on a given underlying topological manifold of dimension at least 5. The theorem just proven gives the first hint that such a procedure might be possible.

EXERCISE 9.1. (PS4.2) Let $M^m \subseteq N^n$ be a submanifold with a normal microbundle \mathfrak{n}_M . Then

$$\mathfrak{t}_M \oplus \mathfrak{n}_M \cong \mathfrak{t}_N|_M.$$

Look in Milnor [Mil64] for the idea, but fill in the details.

Homotopy invariance for microbundles

Cara Hobohm

The content of this section very closely follows [Mil64, Section 6]. Our goal is to prove the following.

THEOREM 10.1. *Let \mathfrak{X} be a microbundle with base space B , and let B' be a paracompact space. Let $f \simeq g: B' \rightarrow B$ be homotopic maps. Then the induced microbundles are isomorphic, i.e.*

$$f^*(\mathfrak{X}) \cong g^*(\mathfrak{X})$$

This has a well-known equivalent for fibre bundles. We'll start by introducing a few notions about map germs. Those will be put to use on microbundles to define bundle map germs. It turns out that the proofs (e.g. Lemma 10.14) look a lot like their fiber bundle analogues once we use those definitions.

10.1. Bundle germs

Definition 10.2. A *map-germ* from (X, A) to (Y, B) is an equivalence class of the elements of the following set

$$\{(f, U) \mid X \supset U \supset A \text{ a neighborhood and a map of pairs } f: (U, A) \rightarrow (Y, B)\}$$

with the equivalence relation $(f, U) \sim (g, V)$ if and only if there is a neighborhood $N \supset A$ with $f|_N \sim g|_N$.

We denote map germs as capital letters $F: (X, A) \rightrightarrows (Y, B)$.

Remember that we introduced microbundles with the goal to construct tangent bundles of topological manifolds. One can think of those map-germs as a work around for derivatives.

First, observe that we can compose two map germs $(X, A) \xrightarrow{F} (Y, B) \xrightarrow{G} (Z, C)$, by taking representatives (f, U) and (g, V) and defining a map $g \circ f|_{f^{-1}(V)}: f^{-1}(V) \rightarrow V \rightarrow g(V)$. Since $f^{-1}(V)$ is a neighborhood of A we can set $F \circ G = [(f \circ g|_{f^{-1}(V)}, f^{-1}(V))]$.

Secondly, we observe that there is a standard identity map germ $\text{Id}: (X, A) \rightrightarrows (X, A)$. This enables us to make another definition:

Definition 10.3. A *homeomorphism-germ* (or *homeo-germ*) is a map germ with a two-sided inverse, i.e. $F: (X, A) \rightrightarrows (Y, B)$ is a homeo-germ if there is $G: (Y, B) \rightrightarrows (X, A)$ such that $F \circ G = \text{Id}_{(Y, B)}$ and $G \circ F = \text{Id}_{(X, A)}$.

The following is a helpful observation to keep control of the definitions introduced so far.

PROPOSITION 10.4. *A map-germ F is a homeo-germ if and only if there is a representative $(f, U) \in F$ that maps U homeomorphically onto its image, and $f(U)$ is a neighborhood of B .*

Proof. " \Leftarrow ": We take the inverse f^{-1} defined on $f(U)$ as a representative for the map-germ inverse G .

" \Rightarrow ": Let G be the map-germ inverse and take representatives $(f, U), (g, V)$ with U open, such that $f(U) \subset V$ and $g \circ f = \text{Id}_U$. We know there is an open subset $V' \subset V$ such that

$g(V') \subset U$ and $f \circ g|_{V'} = \text{Id}_{V'}$. In particular $g|_{V'}$ and $f|_U$ are injective. Take $U' := (f|_U)^{-1}(V')$, which is open with $U' \subset U$. From injectivity follows $f(U') = V'$, which is open and has the continuous inverse $g|_{V'}$. \square

Now let's bring those map germs into the context of microbundles. Consider a microbundle \mathfrak{X} consisting of

$$B \xrightarrow{i} E \xrightarrow{j} B.$$

Definition 10.5. The map germ $J: (E, i(B)) \Rightarrow (B, B)$ induced by j is called the *projection germ*.

To make our notation a little easier, we will write B instead of (B, B) . Furthermore, we identify $i(B)$ with B , for example we just denote the projection germ as $J: (E, B) \Rightarrow B$.

Now let's introduce another microbundle $\mathfrak{X}': B' \xrightarrow{i'} E' \xrightarrow{j'} B'$. After all, we are interested in maps between microbundles. This \mathfrak{X}' has the projection germ $J': (E', B') \Rightarrow B'$.

Definition 10.6. Suppose $B = B'$. An *isomorphism germ* (or iso-germ) from \mathfrak{X} to \mathfrak{X}' is a homeo-germ $F: (E, B) \Rightarrow (E', B)$ that is *fibre preserving*, i.e. $J' \circ F = J$.

Indeed, this definition translates isomorphisms of microbundles into germ-language:

PROPOSITION 10.7. *An iso-germ exists from \mathfrak{X} to \mathfrak{X}' exists if and only if $\mathfrak{X} \cong \mathfrak{X}'$ as microbundles.*

Proof. " \implies ": Take a representative (f, V) , which we choose with $f: V \xrightarrow{\cong} f(V)$ using Proposition 10.4 This means $f(V)$ is an open neighborhood of B in E' . Fiber preservation implies $j' \circ f|_V = j|_V$. We get the diagram for microbundle isomorphisms:

$$\begin{array}{ccc} & V & \\ & \nearrow i & \searrow j \\ B & & B \\ & \searrow i' & \nearrow j' \\ & f(V) & \end{array}$$

$f \cong$

" \impliedby ": Given such a diagram, we take (f, V) to represent the iso-germ. \square

More generally, we want to consider maps between microbundles on different base spaces $B \neq B'$ but with the same fiber dimension.

Definition 10.8. Let $F: (E, B) \Rightarrow (E', B')$ be a map germ, with some representative $f: U \rightarrow E'$. We say F is a *bundle map germ* from \mathfrak{X} to \mathfrak{X}' if there is a neighborhood $V \supset B$ with $V \subset U$ such that for every $b \in B$ exists $b' \in B'$ so that f maps $V \cap j^{-1}(b)$ injectively to $j'^{-1}(b')$.

$$f|_{V \cap j^{-1}(b)}: V \cap j^{-1}(b) \hookrightarrow j'^{-1}(b')$$

We denote such a bundle map germ by $F: \mathfrak{X} \Rightarrow \mathfrak{X}'$.

Let's look at this definition for a moment. We should ensure that the existence of such a V does not depend on the choice of representative (f, U) . Well, any other representative (f', U') can be restricted to some $W \supset B$ so that $f'|_W = f|_W$. Now $V \cap W$ fulfills the definition for (f', U') .

Given a bundle map germ $F: \mathfrak{X} \Rightarrow \mathfrak{X}'$, the definition above ensures that the following diagram commutes:

$$\begin{array}{ccc} (E, B) & \xrightarrow{F} & (E', B') \\ \Downarrow J & & \Downarrow J' \\ B & \xrightarrow{F|_B} & B' \end{array}$$

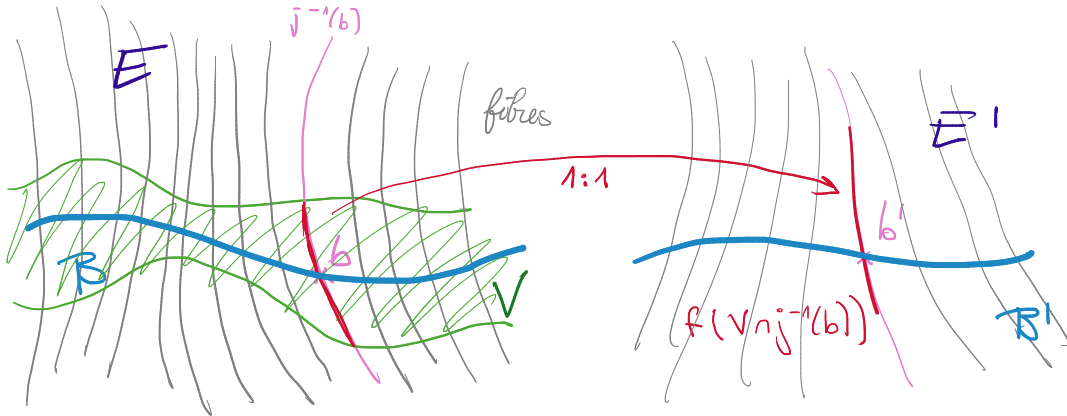

FIGURE 10.1. Visualization of a bundle map germ

We say that $F|_B$ is covered by a bundle map germ F . But be aware that the condition $f: V \cap j^{-1}(b) \rightarrow j'^{-1}(b')$ is stronger than $J' \circ F = F|_B \circ J$.

10.2. Proof of Homotopy Invariance

Remember that we are trying to prove Homotopy Invariance for microbundles.

Theorem 10.1. Let \mathfrak{X} be a microbundle with base space B , and let B' be a paracompact space. Let $f \simeq g: B' \rightarrow B$ be homotopic maps. Then the induced microbundles are isomorphic, i.e.

$$f^*(\mathfrak{X}) \cong g^*(\mathfrak{X})$$

With the definitions above we have developed sufficient language to give a proof. We will need two more ingredients.

Lemma 10.9. Suppose \mathfrak{X} and \mathfrak{X}' are microbundles over the same base space $B = B'$, and suppose $F: \mathfrak{X} \Rightarrow \mathfrak{X}'$ is a bundle map germ covering Id_B . Then F is an iso-germ.

Lemma 10.14. Let \mathfrak{X} be a microbundle over $B \times [0, 1]$, where B is paracompact. Then the standard retraction

$$r: B \times [0, 1] \rightarrow B \times [1]$$

is covered by a bundle map germ $R: \mathfrak{X} \rightarrow \mathfrak{X}|_{B \times [1]}$.

For now we assume those two lemmas hold and prove them later.

Proof of Theorem 10.1. Let \mathfrak{X} be a microbundle with base space B , and let B' be a paracompact space. Let $H: B' \times [0, 1] \rightarrow B$ be a homotopy from $H_0 = f$ to $H_1 = g$. Let $R: H^*\mathfrak{X} \Rightarrow H^*\mathfrak{X}|_{B' \times [1]}$ be the bundle map germ covering the standard retraction from Lemma 10.14. Look at the following diagram:

$$\begin{array}{ccccccc}
 f^*\mathfrak{X} & \xrightarrow{\quad} & H^*\mathfrak{X} & \xrightarrow{R} & H^*\mathfrak{X}|_{B' \times [1]} & \xrightarrow{\quad} & g^*\mathfrak{X} \\
 \Downarrow J & & \Downarrow & & \Downarrow & & \Downarrow J \\
 B' & \xrightarrow{\text{Id}_B \times (0)} & B' \times [0, 1] & \xrightarrow{r} & B' \times [1] & \xrightarrow{\quad} & B' \\
 & & & & & \searrow & \\
 & & & & & \text{Id}_B &
 \end{array}$$

Here the left and right bundle map germs are the obvious ones. Observe that the composition of the bottom maps is $\text{Id}_{B'}$. Taking the composition of the bundle map germs on top therefore leads to a bundle map germ $f^*\mathfrak{X} \Rightarrow g^*\mathfrak{X}$ that covers the identity. Lemma 10.9 finishes the proof. \square

10.3. Proof of Ingredients

LEMMA 10.9. *Suppose \mathfrak{X} and \mathfrak{X}' are microbundles over the same base space $B = B'$, and suppose $F: \mathfrak{X} \Rightarrow \mathfrak{X}'$ is a bundle map germ covering Id_B . Then F is an iso-germ.*

Proof. It is clear from the definition (see diagram 10.1), that a bundle map germ covering the identity is fiber preserving. We have to concern ourselves with showing that F is a homeomorphism germ.

We start by proving a special case before we move on to the general case. Assume \mathfrak{X} and \mathfrak{X}' are trivial, i.e. $E = E' = B \times \mathbb{R}^n$. For $x \in \mathbb{R}^n$ and $\varepsilon > 0$ we will denote the open ball of radius ε at x as $D_\varepsilon(x)$. We want to show any bundle map germ $F: E \rightarrow E'$ covering the identity is a homeo germ. Take a representative $g: U \rightarrow E'$ with $B \subset U \subset B \times \mathbb{R}^n$ open. The definition of bundle map germ combined with the information that F covers Id_B tells us that g maps $U \cap j^{-1}(b)$ injectively to $j'^{-1}(b)$. (W.l.o.g. we have chosen U small enough.) Hence g is injective and fiber preserving.

Claim: Every map $g: U \rightarrow B \times \mathbb{R}^n$ that is injective and fiber preserving is an open mapping.

Observe first, that g can be expressed as $g(b, x) = (b, g_b(x))$ for $b \in B$, with $g_b: U_b \rightarrow \mathbb{R}^n$ defined on the open set $U_b := j^{-1}(b) \cap U$. By definition of the bundle map germ, g_b is injective, thus Invariance of domain implies that every g_b is an open mapping. Now given some point $p_0 := (x_0, b_0) \in B \times \mathbb{R}^n$, we write $g_{b_0}(x_0) =: x_1$ and $g(p_0) = g(b_0, x_0) = (b_0, x_1) =: p_1$. In order to show that g is open, we have to show that for any open neighborhood U_0 of p_0 there is an open neighborhood U_1 of p_1 such that $g(U_0) \supset U_1$.

Given U_0 we start by choosing $\varepsilon > 0$ so that $D_\varepsilon(x_0) \subset \text{proj}_{\mathbb{R}^n}(U_0)$. Since g_{b_0} is an open map, there is $\delta > 0$ so that $D_{2\delta}(x_1) \subset g_{b_0}(D_\varepsilon(x_0))$. There exists a neighborhood V of b_0 in B such that

$$|g_b(x) - g_b(x_0)| < \delta \quad \forall b \in V, x \in D_\varepsilon(x_0)$$

Hence for each $b \in V$ holds $D_\delta(x_1) \subset g_b(D_\varepsilon(x_0))$, thus $g(V \times D_\varepsilon(x_0)) \supset V \times D_\delta(x_1) =: U_1$.

A consequence of the Claim is that g is an embedding. It maps U homeomorphically onto $g(U)$ (which is open in E') and we can apply Proposition 10.4 to see that F is a homeo-germ.

Now the general case. Let \mathfrak{X} and \mathfrak{X}' be microbundles over B and let $F: \mathfrak{X} \Rightarrow \mathfrak{X}'$ be a bundle map germ covering Id_B . Take a representative $f: U \rightarrow E'$ of F , where we choose U small enough to assume f is injective and fiber preserving.

For any $b \in B$ exists a neighborhood W_b of $i(b)$ in U such that $\mathfrak{X}|_{W_b}$ is trivial. Set $C_b := j(W_b)$. Clearly the restriction $F|_{\mathfrak{X}|_{C_b}}$ covers the identity on C_b . We can choose W_b small enough that $\mathfrak{X}'|_{C_b}$ is trivial as well, and then we can apply the first case. This means $f|_{W_b}$ is a homeomorphism onto its image, with $f(W_b) \subset E'$ open.

Now we define $W := \bigcup_{b \in B} W_b$ and obtain $f: W \xrightarrow{\cong} f(W)$, where $f(W)$ is open in E' . Proposition 10.4 asserts that we get a homeo-germ. \square

COROLLARY 10.10. *If a map $g: B \rightarrow B'$ is covered by a bundle map germ $G: \mathfrak{X} \Rightarrow \mathfrak{X}'$, then $\mathfrak{X} \cong g^*\mathfrak{X}'$.*

Proof. The gist is that G induces a bundle map germ $F: \mathfrak{X} \Rightarrow g^*\mathfrak{X}'$ that covers the identity Id_B . Then we can apply Lemma 10.9 above.

Let's spell out how we get this F . Start with a representative $g: V \rightarrow E'$ of G , such that for any $b \in B$ exists $b' \in B'$ with $g: j^{-1}(b) \cap V \rightarrow j'^{-1}(b')$ injective. Remember that the induced

bundle $g^*\mathfrak{X}'$ is the pullback in the following diagram:

$$\begin{array}{ccc}
 V & & \\
 \downarrow f & \searrow g & \\
 g^*E' & \longrightarrow & E' \\
 \downarrow g^*j' & & \downarrow j' \\
 B & \xrightarrow{g} & B'
 \end{array}$$

The universal property of pullbacks induces the dotted map f . Since $j|_V = g^*j' \circ f$, we immediately get that $f|_B$ is the identity. Also f represents a bundle map germ, because the diagram reduces to the following when we start with $\{b'\} \subset B'$:

$$\begin{array}{ccc}
 V \cap j^{-1}(b) & & \\
 \downarrow f & \searrow g & \\
 g^*j'^{-1}(b) & \longrightarrow & j'^{-1}(b') \\
 \downarrow g^*j' & & \downarrow j' \\
 \{b\} & \xrightarrow{g} & \{b'\}
 \end{array}$$

In the diagram restrictions are left out for improved readability. Since the restriction of g is injective, so is f . In conclusion is (f, V) a representative for our bundle map germ F . \square

For the second ingredient we have to make some observations about how to piece bundle maps together before we can build one that covers the standard retraction.

LEMMA 10.11. *Let \mathfrak{X} be a microbundle over B , and let $\{B_\alpha\}_{\alpha \in A}$ be a locally finite collection of closed sets that cover B . Suppose for all $\alpha \in A$ we have bundle map germs to some microbundle \mathfrak{N} :*

$$F_\alpha: \mathfrak{X}|_{B_\alpha} \Rightarrow \mathfrak{N}$$

such that for any $\alpha, \beta \in A$ the restrictions of F_α and F_β agree, i.e.:

$$F_\alpha|_{\mathfrak{X}|_{B_\alpha \cap B_\beta}} = F_\beta|_{\mathfrak{X}|_{B_\alpha \cap B_\beta}}$$

Then there is a bundle map germ $F: \mathfrak{X} \Rightarrow \mathfrak{N}$ extending the F_α , i.e. $F|_{\mathfrak{X}|_{B_\alpha}} = F_\alpha$ for all $\alpha \in A$.

Proof. Take $f_\alpha: U_\alpha \rightarrow E'$ some representative for F_α . By definition there are open neighborhoods $U_{\alpha\beta}$ of $B_\alpha \cap B_\beta$ inside $U_\alpha \cap U_\beta$ such that $f_\alpha|_{U_{\alpha\beta}} = f_\beta|_{U_{\alpha\beta}}$. Define the following set:

$$U = \left\{ e \in E \mid \begin{array}{l} j(e) \in B_\alpha \implies e \in U_\alpha \\ j(e) \in B_\alpha \cap B_\beta \implies e \in U_{\alpha\beta} \end{array} \right\}.$$

Claim: This set U is open.

Take some $e_0 \in U$. As $\{B_\alpha\}$ is a locally finite cover of B , we have some neighborhood V_0 of $j(e_0)$ that intersects only finitely many, let's say $B_{\alpha_1}, \dots, B_{\alpha_k}$. Look at $W := \bigcap_{1 \leq i < j \leq k} U_{\alpha_i \alpha_j}$. Since we only intersect finitely many sets W is open. Define $V_1 := j^{-1}(V_0) \cap W$. This fulfills $e_0 \in V_1 \subset U$ and V_1 is open.

We can define $f: U \rightarrow E'$ that extends the f_α . This is the representative for F . \square

PROPOSITION 10.12. *Let \mathfrak{X} be a microbundle over $B \times [0, 1]$ such that both $\mathfrak{X}|_{B \times [0, \frac{1}{2}]}$ and $\mathfrak{X}|_{B \times [\frac{1}{2}, 1]}$ are trivial. Then \mathfrak{X} is trivial.*

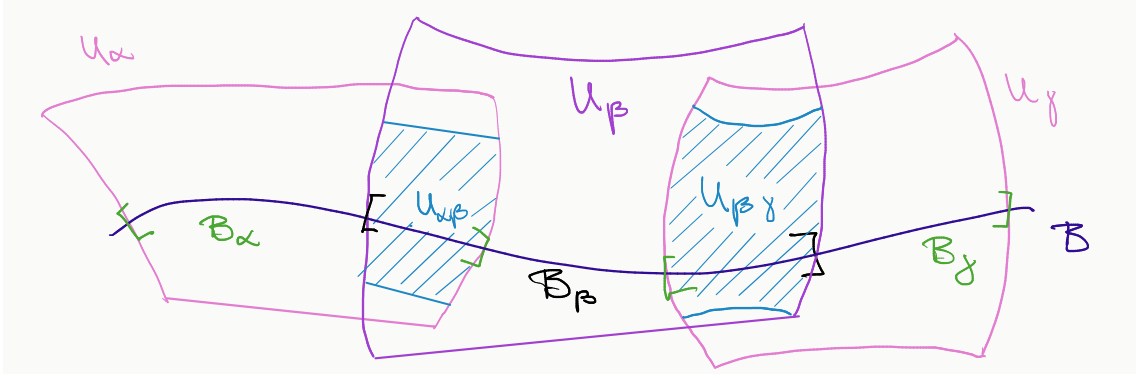
FIGURE 10.2. Visualization of the $U_{\alpha\beta}$

Proof. Look at the "obvious" restriction map $f: B \times [0, 1] \rightarrow B \times [\frac{1}{2}, 1]$. Since $\mathfrak{X}|_{B \times [0, \frac{1}{2}]}$ and $\mathfrak{X}|_{B \times [\frac{1}{2}, 1]}$ are trivial, we can cover the maps $f_1: B \times [0, \frac{1}{2}]$ and $f_2: B \times [\frac{1}{2}, 1]$ with bundle map germs:

$$\begin{aligned} F_1: \mathfrak{X}|_{B \times [0, \frac{1}{2}]} &\Rightarrow \mathfrak{X}|_{B \times [\frac{1}{2}]} \\ F_2: \mathfrak{X}|_{B \times [\frac{1}{2}, 1]} &\Rightarrow \mathfrak{X}|_{B \times [\frac{1}{2}]} \end{aligned}$$

Now we can apply Lemma 10.11 to the locally finite covering $B \times [0, \frac{1}{2}]$, $B \times [\frac{1}{2}, 1]$ to obtain a bundle map germ $F: \mathfrak{X} \Rightarrow \mathfrak{X}|_{B \times [\frac{1}{2}]}$ which covers the restriction $f: B \times [0, 1] \rightarrow B \times [\frac{1}{2}, 1]$. Corollary 10.10 tells us $\mathfrak{X} \cong f^* \mathfrak{X}|_{B \times [\frac{1}{2}]}$. Since $\mathfrak{X}|_{B \times [\frac{1}{2}]}$ is trivial, we see that $f^* \mathfrak{X}|_{B \times [\frac{1}{2}]}$ is trivial, and finally deduce that \mathfrak{X} is trivial. \square

The next lemma is important for finding the neighborhoods on which we can start building.

LEMMA 10.13. *Let \mathfrak{X} be a microbundle over $B \times [0, 1]$. Then for every $b \in B$ exists a neighborhood V of b such that $\mathfrak{X}|_{V \times [0, 1]}$ is trivial.*

Proof. Fix $b \in B$. For any $t \in [0, 1]$ we choose an open neighborhood $V_t \times (t - \varepsilon_t, t + \varepsilon_t)$ of (b, t) so that \mathfrak{X} is trivial on there. The compact set $b \times [0, 1]$ can now be covered with finitely many of the sets $(t - \varepsilon_t, t + \varepsilon_t)$. Let those sets be centered at $0 = t_0 < t_1 < \dots < t_n = 1$, and define $V = \bigcap_{i=0}^n V_i$. $V \subset B$ is open because all V_i are open. Now we make a refinement $0 = t'_0 < t'_1 < \dots < t'_m = 1$ so that $|t'_{j-1} - t'_j| < \min_{i=0, \dots, n} \varepsilon_{t_i}$ for all $1 \leq j \leq m$. This ensures that $\mathfrak{X}|_{V \times [t'_{j-1}, t'_j]}$ is trivial for all j . Now we (repeatedly) apply Proposition 10.12 to see that $\mathfrak{X}|_{V \times [0, 1]}$ is trivial. \square

Finally we can prove the last ingredient.

LEMMA 10.14. *Let \mathfrak{X} be a microbundle over $B \times [0, 1]$, where B is paracompact. Then the standard retraction*

$$r: B \times [0, 1] \rightarrow B \times [1]$$

is covered by a bundle map germ $R: \mathfrak{X} \rightarrow \mathfrak{X}|_{B \times [1]}$.

Proof. Lemma 10.13 gives us a covering $\{V_b\}_{b \in B}$ of B with every $\mathfrak{X}|_{V_b \times [0, 1]}$ trivial. Paracompactness of B gives us a locally finite refinement $\{V_\alpha\}_{\alpha \in A}$. Now we choose functions $\lambda_\alpha: B \rightarrow [0, 1]$ so that $\text{supp } \lambda_\alpha \subset V_\alpha$ for all $\alpha \in A$ and $\max_{\alpha \in A} \lambda_\alpha(b) = 1$ for all $b \in B$.

Define the retractions $r_\alpha: B \times [0, 1] \rightarrow B \times [0, 1]$ by

$$r_\alpha(b, t) = (b, \max\{t, \lambda_\alpha(b)\}).$$

If we assign some ordering to A and were to define r as the composition of all r_α in that order, it is well defined because locally we only have finitely many $\lambda_\alpha(b)$. In particular r is the standard retraction:

$$r(b, t) = (b, \max_{\alpha \in A} \{t, \lambda_\alpha(b)\}) = (b, 1).$$

This gives us an idea of what our next steps for the construction of R are:

- (1) Cover each r_α with a bundle map germ $R_\alpha: \mathfrak{X} \Rightarrow \mathfrak{X}$.
- (2) Choose an ordering of A and let the desired bundle map germ $R: \mathfrak{X} \Rightarrow \mathfrak{X}|_{B \times [0,1]}$ be the composition of the R_α in that order.

Step (1): We can write $B \times [0, 1]$ as the union of the following closed sets:

$$\begin{aligned} C_\alpha &:= (\text{supp } \lambda_\alpha) \times [0, 1] \\ D_\alpha &:= \{(b, t) \mid t \geq \lambda_\alpha(b)\} \end{aligned}$$

Since $C_\alpha \subset V_\alpha \times [0, 1]$ we have that $\mathfrak{X}|_{C_\alpha}$ is trivial. Hence the identity map germ of $\mathfrak{X}|_{C_\alpha \cap D_\alpha}$ extends to a bundle map germ $\mathfrak{X}|_{C_\alpha} \Rightarrow \mathfrak{X}|_{C_\alpha \cap D_\alpha}$ that covers $r_\alpha|_{C_\alpha}$. Piece this germ together with the identity map germ on $\mathfrak{X}|_{D_\alpha}$ by Lemma 10.11 to obtain R_α .

Step (2): We have to argue that taking an "infinite" composition makes sense. We use that locally all but finitely many R_α are the identity.

More precisely, we define R on $\{B_\beta\}$, some locally finite covering of B by closed sets, and then glue. Each B_β intersects only finitely many V_α , let's say $V_{\alpha_1}, V_{\alpha_2}, \dots, V_{\alpha_k}$ with $\alpha_1 < \alpha_2 < \dots < \alpha_k$ in our order. The bundle map germ $R_{\alpha_k} \cdots R_{\alpha_2} R_{\alpha_1}$ restricts to

$$R(\beta) := \mathfrak{X}|_{B_\beta \times [0,1]} \Rightarrow \mathfrak{X}|_{B_\beta \times [1]}$$

Lastly, we piece together these $R(\beta)$ with the help of Lemma 10.11. □

10.4. Corollaries to Homotopy Invariance

The most important corollary is the most obvious:

COROLLARY 10.15. *Every microbundle over a paracompact, contractible base space is trivial.*

Another interesting result is the following:

COROLLARY 10.16. *Assume we have a map $f: A \rightarrow B$ with A paracompact. Denote the mapping cone as $Cf = B \cup_f CA$. Then a microbundle \mathfrak{X} over B can be extended to a microbundle over Cf if and only if the induced microbundle $f^*\mathfrak{X}$ is trivial.*

Proof. " \implies ": The composition $A \xrightarrow{f} B \xrightarrow{\text{incl}} Cf$ is always nullhomotopic since the image lies in $CA \simeq \{*\}$. If \mathfrak{X} extends to a microbundle \mathfrak{X}' over Cf , then clearly $\mathfrak{X}'|_B \cong \mathfrak{X}$. Thus $f^*\mathfrak{X} \cong (\text{incl} \circ f)^*\mathfrak{X}'$, which must be trivial by Theorem 10.1.

" \impliedby ": Consider the mapping cylinder $Zf = B \cup_f (A \times [0, 1])$, where we glue $(a, 1) \cong f(a)$ for all $a \in A$. Because B is a retract of Zf we can extend \mathfrak{X} to a microbundle \mathfrak{X}'' over Zf . Now suppose that $f^*\mathfrak{X}$ is trivial. This implies that $\mathfrak{X}''|_{A \times [0]}$ is trivial and thus $\mathfrak{X}''|_{A \times [0, \frac{1}{2}]}$ is trivial as well. This means we have some open set $U \subset E(\mathfrak{X}''|_{A \times [0, \frac{1}{2}]})$ such that $U \cong A \times [0, \frac{1}{2}] \times \mathbb{R}^n$. Hence we can remove a closed subset from $E(\mathfrak{X}'')$ and then assume $E(\mathfrak{X}''|_{A \times [0, \frac{1}{2}]}) \xrightarrow{h} \cong A \times [0, \frac{1}{2}] \times \mathbb{R}^n$. This homeomorphism h is compatible with the projections and inclusions.

Collapsing $A \times [0]$ in Zf to a single point yields Cf . We can create $E(\mathfrak{X}')$ by collapsing $h^{-1}(A \times [0] \times \{x\})$ for each $x \in \mathbb{R}^n$ in $E(\mathfrak{X}'')$. The microbundle structure of \mathfrak{X}'' now induces a microbundle structure on \mathfrak{X}' over the base space Cf . □

The application of this that comes to mind is taking $A = \mathbb{S}^n$ the sphere to extend microbundles along a CW-structure. This corollary is essential for proving that stable isomorphism classes form a group over finite CW-complexes (with the Whitney sum as operation).

10.5. Proof using Kister's Theorem

While one can use Kister's Theorem to prove the Homotopy Invariance for the cases that interest us most, it is unwise to do so. More specifically Corollary 10.15 is used in the proof of Kister's Theorem when we work over simplicial complexes, because it implies that a microbundle over a single simplex is trivial. Still, it is a fun exercise.

COROLLARY 10.17. *Assume Kister's Theorem holds, and that Homotopy Invariance holds for fiber bundles. Let \mathfrak{X} be a microbundle with base space B . Assume B is a topological manifold or a finite simplicial complex and that B' is paracompact. Let $f \simeq g: B' \rightarrow B$ be homotopic maps. Then the induced microbundles are isomorphic, i.e.*

$$f^*(\mathfrak{X}) \cong g^*(\mathfrak{X})$$

Proof. Let $E_1 \subset E$ be so that $E_1 \rightarrow B$ is a fiber bundle ξ (with $\text{Homeo}_0(\mathbb{R}^n)$ as the structure group). Clearly $|\xi| \cong \mathfrak{X}$. Homotopy Invariance for fiber bundles tells us $f^*\xi \cong g^*\xi$. That means the underlying microbundles are isomorphic as well: $|f^*\xi| \cong |g^*\xi|$. The rest is showing that the underlying microbundles are isomorphic to the original induced microbundles, i.e. $|f^*\xi| \cong f^*|\xi| \cong f^*\mathfrak{X}$. \square

I can not claim with absolute certainty that triviality over simplices is the only instance of Homotopy Invariance used in the proof of Kister's Theorem, but this simpler statement can be proven faster than our general statement.

PROPOSITION 10.18. *Let \mathfrak{X} be a microbundle over the standard n -simplex σ . Then \mathfrak{X} is trivial.*

Proof. By definition, there are local trivialisations, i.e. we have open sets $\{B_\alpha\}$ covering σ such that all $\mathfrak{X}|_{B_\alpha}$ are trivial. Since σ is compact we can take a finite subcover B_1, \dots, B_m . Now take a barycentric refinement of σ so that any subsimplex σ_α is contained in some B_{r_α} . In particular, we have bundle map germs $\mathfrak{X}|_{\sigma_\alpha} \Rightarrow \mathfrak{e}_{\sigma_\alpha}^n$ that cover the identity. Now Lemma 10.11 tells us that we get a bundle map germ $\mathfrak{X} \Rightarrow \mathfrak{e}_\sigma^n$ covering the identity. Lemma 10.9 and Proposition 10.7 complete the proof. \square

Part IV

h-cobordisms

Smale's h -cobordism theorem

Arunima Ray

In this chapter we define h -cobordisms and prove Smale's high-dimensional h -cobordism theorem.

Definition 11.1. Let M_0^n and M_1^n be smooth, compact, oriented n -manifolds. A smooth, compact, oriented $(n+1)$ -manifold with $\partial W = -M_0^n \sqcup M_1^n$ is said to be an h -cobordism from M_0^n to M_1^n if the inclusion maps $\iota_i: M_i \rightarrow W$ are homotopy equivalences.

You should think of this as saying that, up to homotopy, h -cobordisms are products, i.e. of the form $M_0^n \times [0, 1]$. The following is a fundamental result in high-dimensional topology.

THEOREM 11.2 (Smale [Sma61][Sma62a]). *Let $n \geq 5$, and W^{n+1} a smooth, compact, oriented, simply connected h -cobordism from M_0^n to M_1^n . Then $W \cong_{C^\infty} M_0 \times [0, 1]$.*

More specifically, there exists a diffeomorphism $\varphi: W \rightarrow M_0 \times [0, 1]$, where the restriction $\varphi|_{M_0}: M_0 \rightarrow M_0$ is the identity map. Note that the restriction $\varphi|_{M_1}$ is a diffeomorphism from M_1 to M_0 .

As a straightforward corollary of the above, Smale proved the (category losing) high-dimensional Poincaré conjecture, for which we won the Fields medal.

COROLLARY 11.3. *Let $n \geq 6$. Every smooth homotopy n -sphere is homeomorphic to S^n .*

We now sketch a proof of Theorem 11.2. See also [Sco05, Chapter 1][Mil65, Sma60]. For more on the high-dimensional Poincaré conjectures, see [Sta60, Zee62, New66].

Proof of Theorem 11.2. First we note that, as a smooth, compact manifold, W admits a handle decomposition relative to M_0 , i.e. there is an identification of W with the smooth manifold obtained by iteratively attaching finitely many handles to $M_0 \times [0, 1]$ along $M_0 \times \{1\}$ via smooth handle attaching maps, followed by smoothing corners.

For more on the existence of handle decompositions, see [GS99, Sco05, Mil65, Mil63]. Briefly, we begin with a continuous map $W \rightarrow [0, 1]$, approximate it by a smooth function, then in turn by a Morse function. Critical points of Morse functions correspond precisely to handles.

Remark 11.4. There are analogous notions of PL and topological handle decompositions, both in the absolute and relative settings, where handles are attached along PL and topological embeddings, respectively.

The main idea of the proof is to manipulate the handle decomposition of W until all the handles cancel out. A handle decomposition relative to M_0 with no handles is, by definition, diffeomorphic to the product $M_0 \times [0, 1]$. We will modify the handle decomposition by isotopies of the handle attaching maps, including handles slides, and handle cancellation (more on these moves in the Piccirillo lectures (ttss.math.gatech.edu/piccirillo-mini-course)). We will also need the following indispensable tool from differential topology.

THEOREM 11.5 (Submanifold transversality in the smooth category). *Given smooth submanifolds P^p and Q^q in an ambient manifold W^m , we may smoothly isotope P so that P and Q intersect transversely, i.e. the dimension of $P \pitchfork Q$ is $p + q - m$.*

In particular, if $p + q < m$, we may isotope P so that $P \cap Q = \emptyset$.

We now begin manipulating the handle decomposition of W relative to M_0 .

STEP 1. *Arrange that handles are attached in increasing order of index.*

It is relatively straightforward to see that if the handle h' is attached after the handle h , such that the attaching sphere of h' misses the belt sphere of h , then one may reorder the handle attachment so that h is attached after h' . This follows since the attaching sphere for h' can be isotoped away from all of h , for example, by transporting radially away from the belt sphere. Assume that h is a k -handle and h' is an l -handle. Then the dimension of the belt sphere of h is $n - k$ (recall that we are working with $(n + 1)$ -dimensional handles). The dimension of the attaching sphere for h' is $l - 1$. The manifold after attaching h is n -dimensional. So, up to isotopy, we may assume that the intersection between the belt sphere of h and the attaching sphere of h' has dimension $(n - k) + (l - 1) - n = l - k - 1$. In particular, if $k \geq l$, the intersection can be assumed to be empty, and so we can reorder h and h' .

STEP 2. *Cancel all 0-handles (using 1-handles).*

Recall that W is connected. Further, 0-handles are attached along their (empty) attaching region, and the only handles with nonempty, disconnected attaching region are index 1. Hence, at least one of the (finitely many) 0-handles must be attached to $M_0 \times \{1\}$ by a 1-handle, i.e. there is a 1-handle h_1 with one connected component of its attaching region in $M_\times \{1\}$ and the other in the belt sphere ($\cong_{C^\infty} S^n$) of the 0-handle h_0 . In particular, the attaching sphere of h_1 intersects the belt sphere of h_0 precisely once, and the pair may be cancelled and removed from the handle decomposition. This process reduces the number of 0-handles in the handle decomposition by one, and by induction, we may assume that there are no 0-handles in the decomposition moving forward.

STEP 3. *Trade 1-handles for 3-handles.*

Let $W_2 \subseteq W$ denote the union of $M_0 \times [0, 1]$ and the 1- and 2-handles of W . Let M_2 denote the new boundary, so $\partial W_2 = -M_0 \sqcup M_2$.

Consider the chain of inclusion induced maps $\pi_1(M_0) \rightarrow \pi_1(W_2) \rightarrow \pi_1(W)$. Since W is built from W_2 by attaching handles of index strictly greater than 2, the second map is an isomorphism. The composition is an isomorphism by hypothesis. Thus the first map is an isomorphism.

Fix a 1-handle h_1 in W_2 , with core arc α . We claim that there is an arc $\beta \subseteq M_0$ such that $\gamma := \alpha \cup \beta$ is a null-homotopic loop in W_2 . To see this, first choose any arc β' with the same endpoints as α . Then there is some loop $\delta \subseteq M_0$ with the same image in $\pi_1(W_2)$ as $\alpha \cup \beta'$, since the inclusion induced map $\pi_1(M_0) \rightarrow \pi_2(W_2)$ is surjective. The connected sum of β' and δ^{-1} is the desired β . By transversality, we assume that γ is disjoint from the attaching circles of all the 1- and 2-handles of W_2 and then we push γ to the boundary M_2 .

By turning handles upside down, we see that the inclusion induced map $\pi_1(M_2) \rightarrow \pi_1(W_2)$ is an isomorphism. Thus γ bounds an immersed disc in M_2 , since it is null-homotopic in W_2 . Since W_2 has dimension ≥ 5 we can assume that γ bounds an embedded disc in M_2 . (This argument also works in ambient dimension four, see Exercise 11.1).

Thicken this disc to produce a cancelling 2-/3-handle pair. More precisely, insert a collar of $M_2 \times [0, 1]$ into the handle decomposition and thicken by pushing the interior of the disc into this collar. The result is the addition of a single cancelling 2-/3-handle pair compatible with the old handle decomposition. By the choice of γ the 2-handle cancels the 1-handle h_1 , leaving the 3-handle behind. Iterating this process allows us to trade all the 1-handles in W for 3-handles.

STEP 4. *Use the Whitney trick to cancel all the other handles.*

This is the most important step in the argument. (We will describe the Whitney trick in more detail in a subsequent section, with a focus on dimension four.) Let M_2 denote the

n -manifold obtained from M_0 after attaching all the 2-handles in W . Consider the chain complex $C_*(W, M_0; \mathbb{Z})$ given by the (latest) handle decomposition:

$$\longrightarrow C_4 \xrightarrow{\partial_4} C_3 \xrightarrow{\partial_3} C_2 \longrightarrow 0$$

Since C_2 is free and $H_*(W, M_0; \mathbb{Z}) = 0$, the matrix for ∂_3 has the form $\partial_3 = \begin{bmatrix} I_{p \times p} \\ 0_{p' \times p} \end{bmatrix}$ for some p, p' , where $I_{p \times p}$ is the $p \times p$ identity matrix, and $0_{p' \times p}$ is the $p' \times p$ matrix containing only zeros. On the other hand, basis changes can be effected by handle slides (corresponding to elementary row and column operations) and sign changes (corresponding to changing the orientation on individual handles). Therefore, we may assume that for each 2-handle h_2 , there exists a unique 3-handle h_3 so that the belt sphere of h_2 and the attaching sphere of h_3 , both contained in M_2 , intersect algebraically once. If these intersected precisely once *geometrically*, we would be able to cancel the handles. The Whitney trick will tell us precisely why we may assume that these submanifolds do in fact intersect geometrically once, up to isotopy.

Let P^k and Q^{n-k} be transversely intersecting, smooth, compact, connected, oriented submanifolds of M_2^n , where M_2 is simply connected, oriented, and $n \geq 5$. Assume further that $\pi_1(M_2 \setminus (P \cup Q)) = 1$. We skip the proof of this final assumption for the moment, but rest assured this can be arranged in all the cases needed in the proof of Theorem 11.2. By our assumptions, we know that the intersections between P and Q are isolated double points, each equipped with a sign. Choose two intersection points of opposite sign. Choose arcs in P and Q joining the two double points. The union of these two arcs is called a *Whitney circle*. A disc bounded by a Whitney circle is called a *Whitney disc*. Since $\pi_1(M_2 \setminus (P \cup Q)) = 1$, there exists a Whitney disc D in the complement of $P \cup Q$, which may be further assumed to be embedded since $n \geq 5$. Under a condition on the normal bundle of D in M_2 described in the next paragraph, we can push P along D and over, as indicated in Figure 11.1, to geometrically cancel the two algebraically cancelling intersection points. This process is called the *Whitney trick*.

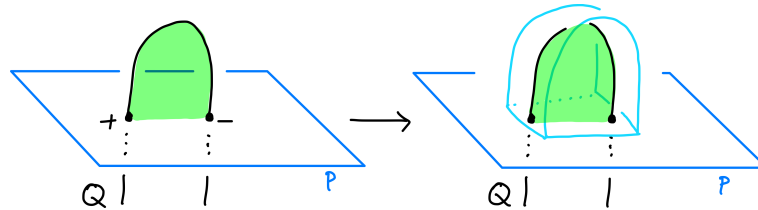

FIGURE 11.1. The Whitney move. Left: A Whitney disc D is shown in light green. Right: The Whitney move across D removes two intersection points.

We now describe the necessary condition on the normal bundle of D . Any embedded disc D with boundary a circle C pairing double points of $P \pitchfork Q$ determines a $(k - 1)$ -dimensional sub-bundle of the normal bundle $\nu_{D \subseteq M_2}|_C$ of D restricted to C , by requiring that the sub-bundle be tangent to P and normal to Q . In order to perform the Whitney trick we need this sub-bundle over the circle C to extend over the entire disc D . Standard bundle theory implies that the sub-bundle extends if and only if it determines the trivial element in $\pi_1(\text{Gr}_{k-1}(\mathbb{R}^{n-2}))$, where the Grassmannian $\text{Gr}_{k-1}(\mathbb{R}^{n-2})$ is the space of $(k - 1)$ -dimensional subspaces in \mathbb{R}^{n-2} . For $n - k \geq 3$, it is known that $\pi_1(\text{Gr}_{k-1}(\mathbb{R}^{n-2})) \cong \mathbb{Z}/2$, and the nontrivial element corresponds to circles pairing intersection points with the same sign. In our current situation, we have $n \geq 5$ and $k \geq 2$, so at least one of k or $k' = n - k$ will satisfy the codimension condition above. Since Whitney circles by definition pair intersection points of opposite sign, the sub-bundle in question extends, and we can perform the Whitney move.

To summarise, we previously knew that for each 2-handle h_2 in W , there exists a unique 3-handle h_3 so that the belt sphere of h_2 and the attaching sphere of h_3 , both contained in M_2 , intersect algebraically once. By the Whitney trick, we can assume, that the belt sphere of h_2 and the attaching sphere of h_3 intersect geometrically once, and therefore, all the 2-handles may be cancelled (using a subset of the 3-handles). But now the process can be iterated, by cancelling every k -handle using a subset of the $(k + 1)$ -handles. At the end of this process, there will be no remaining handles, showing that our original cobordism W is diffeomorphic to the product $M_0 \times [0, 1]$, as desired. \square

EXERCISE 11.1. Let γ be an embedded circle in the interior of a smooth manifold W^m , with $m \geq 4$ and $\pi_1(W) = 1$. Then γ bounds an embedded disc in the interior of W .

Finding a boundary for an open manifold

Alice Merz

12.1. The result

This chapter is based on a paper by W. Browder, J. Levine and G.R. Livesay [BLL65]. The aim is to (partially) answer the following question:

When is an open manifold the interior of a compact manifold with boundary?

In this chapter all manifolds are PL or smooth. Therefore by isomorphism we will mean an isomorphism in the appropriate category.

Definition 12.1. A topological space X is said to be *simply connected at ∞* if for any compact $C \subseteq X$ there exists a compact D , $C \subseteq D \subseteq X$ such that $X \setminus D$ is simply connected.

THEOREM 12.2. *Let W be a connected, orientable, non-compact n -manifold without boundary, with $n \geq 6$. Then there exists a compact manifold U with simply connected boundary such that $W = \text{Int } U$ if and only if $H_*(W)$ is finitely generated and W is simply connected at ∞ . Moreover such a U is unique up to isomorphism.*

Remark 12.3. Notice that if W is the interior of a compact manifold with boundary U then $H_*(W)$ is finitely generated. Moreover if the boundary ∂U is simply connected then of course W is simply connected at ∞ as a consequence of the collaring theorem. In fact for every compact $C \subseteq W$, one can always find an open collar V of the boundary of U which does not intersect C . Let $V' \subsetneq V$ be a subcollar of V such that V' corresponds to $\partial U \times (\frac{1}{2}, 1]$ inside of $V \cong \partial U \times (0, 1]$. Notice that there is an isomorphism $U \xrightarrow{\sim} U \setminus V'$ that is the identity on $U \setminus V$ and shrinks the collar V inside V' . Then $U \setminus V'$ is compact and is contained in W . Set $D = U \setminus V'$, then $C \subset D$ and $W \setminus D \cong \partial U \times (0, +\infty)$ is simply connected, hence W is simply connected at ∞ .

12.2. Proof of uniqueness

THEOREM 12.4. *Let U_1 and U_2 be compact oriented n -manifolds with simply connected boundaries. Suppose that U_1 is embedded in $\text{Int } U_2$ and the inclusion is a homology isomorphism. Suppose as well that $V := U_2 \setminus \text{Int } U_1$ is simply connected. Then V is a h -cobordism between ∂U_1 and ∂U_2 .*

Proof. By excision $H_*(V, \partial U_1) \cong H_*(U_2, U_1)$ and both are trivial since $H_*(U_1) \xrightarrow{\sim} H_*(U_2)$ by hypothesis. Since $\pi_1(V, \partial U_1) = 0$ and ∂U_1 is simply connected, Hurewicz theorem in the relative form implies that $\pi_i(V, \partial U_1) \cong H_i(V, \partial U_1) = 0$ for all i . Hence By Whitehead's theorem it follows that the inclusion of ∂U_1 in V is a homotopy equivalence. By relative Poincaré duality

$$H_j(V, \partial U_2) \cong H^{n-j}(V, \partial U_1) = 0$$

and therefore with a similar process we obtain that the inclusion of ∂U_2 in V is a homotopy equivalence. \square

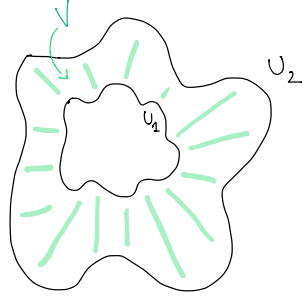

FIGURE 12.1. The manifolds U_1 , U_2 and V in Theorem 14.28.

COROLLARY 12.5. *If $W \cong \text{Int } U_1 \cong \text{Int } U_2$, where U_1 and U_2 are compact manifolds of dimension $n \geq 6$, with simply connected boundaries, then U_1 and U_2 are isomorphic.*

Proof. We can embed U_1 in its interior using a collar of the boundary $A \cong \partial U_1 \times [0, 1]$. Let A' be the subcollar corresponding to $\partial U_1 \times [\frac{1}{2}, 1]$ inside A . Then there is an embedding $U_1 \rightarrow \text{Int } U_1$ that is the identity on $U_1 \setminus A$ and that shrinks the collar A inside A' . Moreover notice that this embedding is homotopic to the identity. Since $\text{Int } U_1 \cong W$, we obtain an embedding $U_1 \hookrightarrow W$. Then $U_1 \hookrightarrow W \hookrightarrow U_2$, where the second map is the embedding induced by $W \cong \text{Int } U_2 \subseteq U_2$. Notice that both maps are homotopy equivalences. If we identify U_1 with its image in U_2 , it follows that $V := U_2 \setminus \text{Int } U_1$ is homotopy equivalent to a collar of ∂U_1 and hence is simply connected. Hence by Theorem 14.28, V is an h -cobordism and therefore $V \cong \partial U_1 \times [0, 1]$ and $U_1 \cong U_2$ by the h -cobordism theorem [Sma62b]. \square

12.3. Proof of Theorem 12.2

Theorem 12.2 is a direct consequence of the following proposition:

PROPOSITION 12.6. *Let W be an oriented open n -manifold, with $n \geq 6$. Suppose $H_*(W)$ is finitely generated and W is simply connected at ∞ . Then given a compact set C there is a connected compact n -manifold U , with simply connected boundary, such that $U \subseteq W$, $C \subseteq \text{Int } U$ and the inclusion induced map*

$$H_*(U) \rightarrow H_*(W)$$

is an isomorphism.

Proof of Theorem 12.2. Let $C_1 \subsetneq C_2 \subsetneq \dots \subsetneq W$ be a sequence of compact sets such that $W = \bigcup_{i=1}^{\infty} C_i$. Since W is simply connected at ∞ we may suppose that $W \setminus C_i$ is simply connected. By Proposition 12.6 for every i we can find a manifold with boundary U_i such that $U_{i-1} \cup C_i \subseteq \text{Int } U_i$, ∂U_i is simply connected and the inclusion induced map in homology is an isomorphism.

obtained by gluing the at each step the maps as shown above. Therefore

$$W = \bigcup_{i=1}^{\infty} U_i = \bigcup_{i=1}^{\infty} U_1 \cup \partial U_1 \times [0, i-1] = U_1 \cup \partial U_1 \times [0, +\infty)$$

and W is isomorphic to the interior of U_1 . \square

12.4. Proof of Proposition 12.6

The following lemma allows us to find a compact n -manifold $U \subseteq W$ with simply connected boundary and such that $W \setminus U$ is simply connected as well.

LEMMA 12.7. *Let W be a connected manifold of dimension $n \geq 5$, simply connected at ∞ and such that $H_*(W)$ is finitely generated. Then for $C \subseteq W$ a compact subset there exists a compact n -manifold U with simply connected boundary such that $C \subseteq \text{Int } U$ and $W \setminus U$ is simply connected and the inclusion induced map in homology*

$$H_*(U) \rightarrow H_*(W)$$

is surjective.

Proof. Since $H_*(W)$ is finitely generated we can always find a compact set $K \subseteq W$ such that

$$H_*(K) \rightarrow H_*(W)$$

is onto. In fact, we just need to take a representative for each element of a finite set of generators of $H_*(W)$. Therefore if O is any subset of W such that $K \subseteq O \subseteq W$, the following diagram commutes:

$$\begin{array}{ccc} H_*(K) & \longrightarrow & H_*(W) \\ & \searrow & \nearrow \\ & H_*(O) & \end{array}$$

and hence $H_*(O) \rightarrow H_*(W)$ is surjective too.

Let D be compact so that $C \cup K \subseteq D \subseteq W$ and $W \setminus D$ is simply connected. Such a D always exists because W is simply connected at ∞ . We can find a compact manifold with boundary U^1 with $D \subseteq \text{Int } U^1$:

- In the smooth case by choosing a proper smooth function $f : D \rightarrow \mathbb{R}$ such that $f|_D \equiv 0$. We can pick a regular value ε and fix $U^1 := f^{-1}([0, \varepsilon])$;
- In the PL case D lies in a finite subcomplex of W : we take U^1 to be a regular neighbourhood of K in W .

We can assume U^1 to be connected by taking ambient connected sums along the boundary: in fact we can join the connected components by arcs and then add to U^1 a regular neighbourhood for each arc.

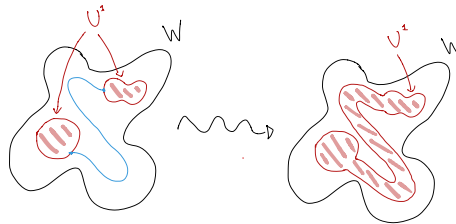

FIGURE 12.4. Ambient connected sum along the boundary.

By the fact that W is connected at ∞ it follows that all but one of the connected components of $W \setminus U^1$ are compact. Let U^2 be the union of U^1 and the compact components of $W \setminus U^1$, so that both U^2 and $W \setminus U^2$ are connected.

Since $W \setminus U^2$ is a connected manifold, then it is path connected and we can join the components of ∂U^2 by disjoint arcs with their interiors contained in $W \setminus U^2$. We define U^3 to be the union of U^2 and closed regular neighbourhoods of these arcs. Notice that U^3 and ∂U^3 are connected. Observe that $W \setminus U^3$ is connected as well: in fact $W \setminus U^2$, which is connected, can be obtained by gluing back the regular neighbourhoods of the arcs, which are isomorphic to $D^{n-1} \times D^1$ along a piece of the boundary isomorphic to $\partial D^{n-1} \times D^1$ which is also connected because n is strictly bigger than 2 and this easily implies by a Mayer-Vietoris argument that $W \setminus U^3$ is connected.

Now we want to do surgery on the boundary of U^3 to make it simply connected. Let γ be a generator of $\pi_1(\partial U^3)$. We can suppose that γ is a simple closed curve and that it is smooth (respectively PL) if we are in the smooth case (respectively PL) since $\dim(\partial U^3) \geq 3$.

Since $W \setminus D$ is simply connected, there is a map $f : D^2 \rightarrow W \setminus D$ that restricts to γ on the boundary. Since the dimension $n \geq 5$ we can approximate this map relative to the boundary with a smooth embedding and we can also suppose it is transverse to ∂U^3 . Consider the inverse image of $f(D^2) \cap \partial U^3$ in D^2 : this is a collection of simple closed curves in the interior of D^2 . Take an innermost one δ ; this curve bounds a disc $\Delta \subseteq D^2$ whose image is either contained in U^3 or in $\overline{W \setminus U^3}$. If it is contained in U^3 we carve a regular neighbourhood of $f(\Delta)$ out of U^3 , otherwise, when the image of the disc Δ is contained in $\overline{W \setminus U^3}$ we add a regular neighbourhood $N \cong D^2 \times D^{n-2}$ of $f(\Delta)$ to U^3 . Call the new manifold U^4 . Suppose now $f(\Delta) \subseteq U^3$, the other case being analogous. Observe that $U^3 \setminus \text{Int } U^4$ is homotopy equivalent to $\partial U^3 \cup f(\Delta)$ and therefore

$$\pi_1(U^3 \setminus \text{Int } U^4) \cong \pi_1(\partial U^3) / \langle \delta \rangle.$$

Call $B = \{0\} \times D^{n-2} \subset N$ the cocore of the regular neighbourhood and notice that $U^3 \setminus \text{Int } U^4$ is homotopy equivalent to

$$\partial U^4 \cup B.$$

Since $n \geq 5$, the boundary of this disc is simply connected and Seifert-van Kampen theorem implies

$$\pi_1(\partial U^4) \cong \pi_1(\partial U^4 \cup B) \cong \pi_1(U^3 \setminus \text{Int } U^4) \cong \pi_1(\partial U^3) / \langle \delta \rangle$$

We can keep on carving out or adding a regular neighbourhood of the disc bounded by the innermost curve until we reach and kill γ . Repeating the same process for a finite set of generators of $\pi_1(\partial U^3)$, which exists because ∂U^3 is compact, we obtain a compact manifold U with simply connected boundary. Notice that

$$\pi_1(W \setminus U) * \pi_1(U \setminus D) = \pi_1(W \setminus D) = 1$$

and therefore $W \setminus U$ is simply connected as well. Since $K \subseteq U$, then $H_*(U) \rightarrow H_*(W)$ is onto. \square

We now prove a weaker version of Proposition 12.6.

PROPOSITION 12.8. *Let W be a connected and orientable open n -manifold, with $n \geq 6$. Suppose $H_*(W)$ is finitely generated and W is simply connected at ∞ . Then given a compact $C \subseteq W$ and $k \leq n - 3$, there is a compact n -manifold with boundary U , with $C \subseteq \text{Int } U$, such that ∂U and $W \setminus U$ are simply connected and such that the inclusion induced homomorphisms*

$$H_i(U) \rightarrow H_i(W)$$

are isomorphisms when $i < k$ and are onto for all i .

We will prove Proposition 12.8 by induction and we shall show now the base case of the induction.

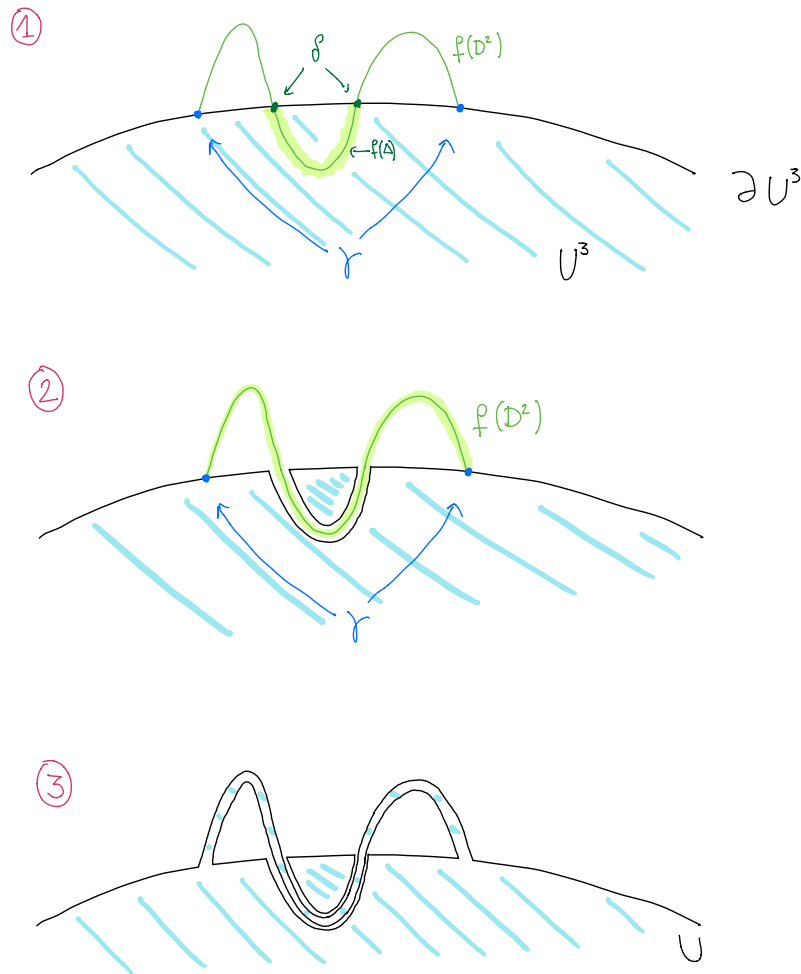

FIGURE 12.5. The procedure described in the proof of Theorem 29.7: at first there is a curve γ which is non-trivial in $\pi_1(\partial U^3)$, in the second step we carved out a regular neighbourhood of $f(\Delta)$. At last, after applying repeatedly the described procedure, we obtain U with simply connected boundary.

Proof of Proposition 12.8.

Base case: $i = 0, 1, 2$

Thanks to Lemma 29.7 we may find a compact manifold $U_1 \subseteq W$ with simply connected boundary, such that $C \subseteq \text{Int } U_1$, the manifold $W \setminus U_1$ is simply connected and $H_*(U_1) \rightarrow H_*(W)$ is onto. Notice that by construction both U_1 and W are connected and that $\pi_1(U_1) \cong \pi_1(W)$, hence

$$H_i(U_1) \xrightarrow{\cong} H_i(W) \text{ for } i=0,1.$$

Let $V_1 := \overline{W \setminus U_1}$ and consider the following commutative diagram with exact rows:

$$\begin{array}{ccccccccccc} \cdots & \longrightarrow & H_{k+1}(V_1) & \xrightarrow{j'} & H_{k+1}(V_1, \partial U_1) & \xrightarrow{\partial'} & H_k(\partial U_1) & \xrightarrow{i'} & H_k(V_1) & \longrightarrow & \cdots \\ & & \downarrow & & \downarrow \cong & & \downarrow & & \downarrow & & \\ \cdots & \longrightarrow & H_{k+1}(W) & \xrightarrow{j} & H_{k+1}(W, U_1) & \xrightarrow{\partial} & H_k(U_1) & \xrightarrow{i} & H_k(W) & \longrightarrow & \cdots \end{array}$$

The second vertical arrow is an isomorphism for all k due to excision. Therefore, since i is onto for all k , the map j is trivial and also j' needs to be trivial for all k . Similarly if i' is injective then ∂' is trivial and ∂ must be trivial too, hence i is injective for all k . Therefore we just need to kill the kernel of i' , and this will kill the kernel of i . Let $x \in H_2(\partial U_1)$ be a generator of $\ker(i')$.

Note that, since ∂U_1 is simply connected, the Hurewicz theorem implies that an element $x \in H_2(\partial U_1)$ can be represented by a map $f : S^2 \rightarrow \partial U_1$.

Moreover, since V_1 is simply connected too, if $i'x = 0$ in $H_2(V_1)$ then f is homotopic to a constant in V_1 .

In the smooth case, since the dimension of ∂U_1 is $n - 1 \geq 5$, by a general position argument f is homotopic to an embedding $g : S^2 \rightarrow \partial U_1$. If $n > 6$, since $i'x = 0$ this map extends to an embedding $\bar{g} : D^3 \rightarrow V_1$ which meets ∂U_1 transversally in $\partial D^3 = S^2$ only. When $n = 6$ we can suppose \bar{g} is an immersion with only transverse double points: these intersections can be removed by applications of the Whitney trick and therefore we can suppose \bar{g} is an embedding. The PL case can be handled similarly using analogous results of Irwin [Irw62].

Define U'_1 as $U_1 \cup \mathcal{N}$, where $\mathcal{N} \cong D^3 \times D^{n-3}$ is a regular neighbourhood of $\bar{g}D^3$. Notice that the intersection of $V_1 \setminus \bar{g}D^3$ and the regular neighbourhood \mathcal{N} is homotopy equivalent to S^{n-4} . Since $n \geq 6$

$$1 \cong \pi_1(V_1) \cong \pi_1(V_1 \setminus \bar{g}D^3) * \pi_1(\mathcal{N}).$$

Notice that $W \setminus U'_1$ and $V_1 \setminus \bar{g}D^3$ are homotopy equivalent and hence $W \setminus U'_1$ is simply connected. Similarly $\partial U'_1$ is homotopy equivalent to $\partial U_1 \cup \mathcal{N} \setminus \bar{g}D^3$ and

$$1 \cong \pi_1(\partial U_1) * \pi_1(\mathcal{N}) \cong \pi_1(\partial U_1 \cup \mathcal{N}) \cong \pi_1(\partial U_1 \cup \mathcal{N} \setminus \bar{g}D^3) * \pi_1(\mathcal{N}).$$

Therefore $\partial U'_1$ is simply connected as well. Let $V'_1 = \overline{W \setminus U'_1}$ and $k' : H_*(\partial U'_1) \rightarrow H_*(V'_1)$ be the inclusion induced homomorphism. Notice that

$$H_j(\partial U'_1) \cong H_j(\partial U_1)$$

for $j \neq 2, n - 3$ and

$$H_2(\partial U'_1) \cong H_2(U_1)/(x)$$

and by Poincaré duality a similar result holds for $j = n - 3$.

Then $\ker(k')_2 \cong \ker(i')_2/(x)$ and we did not increase the number of generators of $\ker(i')_j$ for $j \neq 2$. Iterating this procedure we arrive at $U_2 \supset U_1$ such that $H_2(U_2) \rightarrow H_2(W)$ is an isomorphism, and both ∂U_2 and $V_2 := \overline{W \setminus U_2}$ are simply connected, proving the statement of Proposition 12.8 for $k = 2$.

Inductive step: $k \implies k + 1$

We will need the following:

LEMMA 12.9. *Let X be an n -manifold with boundary with $n \geq 6$, $\partial X = M \sqcup N$, where M , N and X are simply connected. Suppose $\pi_j(X, M) = 0$ for $2 \leq j < k - 1 < n - 4$. Then any element $w \in H_{k+1}(X, M)$ can be represented by a properly embedded disc $D^{k+1} \subseteq X$.*

Proof. We will just prove the theorem in the smooth case, using the handlebody theory of Smale [Sma62b]; the PL case follows from analogous facts proven by Stallings [Sta62b].

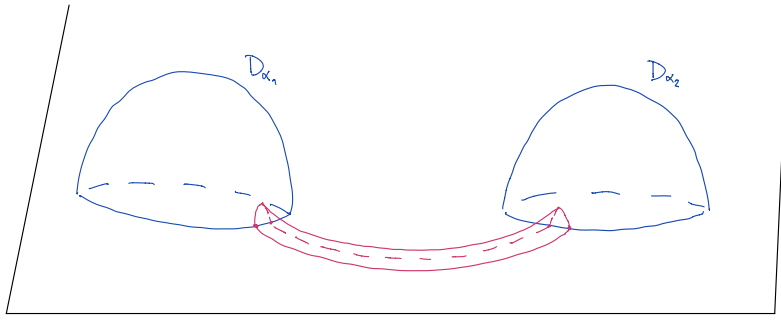

FIGURE 12.6. Two discs D_{α_1} and D_{α_2} connected by a tube $D^k \times I$.

By a theorem of Smale [Sma62b] we can say that X has a handle decomposition relative to M

$$X = \bigcup_{i=k-1}^n X_i$$

where $X_{k-1} = M \times I$ and X_j is obtained from X_{j-1} attaching j -handles on $\partial X_{j-1} \setminus M \times \{0\}$.

Since X_j has the homotopy type of X_{j-1} with some j -discs attached, it follows that

$$H_i(X_j, M) \rightarrow H_i(X, M)$$

is an isomorphism for $i < j$ and surjective for $i = j$. Therefore there exists $w' \in H_{k+1}(X_{k+1}, M)$ such that w' is sent to w in $H_{k+1}(X, M)$. Consider the long exact sequence in homology of the triple (X_{k+1}, X_k, M) :

$$\cdots \rightarrow H_{k+1}(X_{k+1}, M) \xrightarrow{k_*} H_{k+1}(X_{k+1}, X_k) \xrightarrow{\partial} H_k(X_k, M) \rightarrow \cdots$$

Let $y = k_* w'$. Notice that $H_{k+1}(X_{k+1}, X_k) \cong \mathbb{Z}^p$ where p is the number of $(k+1)$ -handles and it is freely generated by the cores of the $(k+1)$ -handles.

Recall that our goal is to represent w by a properly embedded disc D^{k+1} . We start by representing y as an embedded disc. It is a theorem of Smale [Sma62b] (see also Wallace [Wal61]) that if we are given any basis for $H_{k+1}(X_{k+1}, X_k)$ we may find some handles H_1, \dots, H_r in X_{k+1} attached to X_k so that $X_{k+1} = X_k \cup \bigcup_{i=1}^r H_i$ and the cores of the H_i 's yield the given basis of $H_{k+1}(X_{k+1}, X_k)$.

Hence we may assume that $y = mz$, z being the core of one of the handles of X_{k+1} . Since the codimension is strictly bigger than one, y can also be represented as a properly embedded disc. In fact, let z be the core of a handle $H_i \cong D^{k+1} \times D^{n-k-1}$. Pick m different points $p_\alpha \in D^{n-k-1}$, and let $D_\alpha = D^{k+1} \times \{p_\alpha\} \subseteq H_i$. Since $n - k - 1 > 1$ the boundaries of the D_α 's do not separate $\partial D^{k+1} \times D^{n-k-1}$. Hence we can join $S_\alpha^k = \partial D_\alpha$ by tubes $S^{k-1} \times I$ in $S^k \times D^{n-k-1}$ to form the connected sum of the S_α^k 's and the D_α 's can be connected by tubes $D^k \times I$ in $H_i \cong D^{k+1} \times D^{n-k-1}$ to form the connected sum along the boundaries of the D_α with the proper orientation and we can call the resulting disc D .

Then D has the homology class of y in $H_{k+1}(X_{k+1}, X_k)$. This disc is attached to ∂X_k rather than $M \times \{1\}$ so it remains to show that it can be chosen to miss the handles of X_k .

If the boundary on the disc does not meet the belt sphere of any k -handle in ∂X_k by handle sliding it can be moved off these handles by an isotopy. Suppose now that the algebraic intersection of ∂D with one belt sphere is zero. Then, taken two intersection points with opposite sign we can apply the Whitney trick to lower the number of intersection points: iterating this procedure we obtain that ∂D does not intersect the belt spheres of the k -handles.

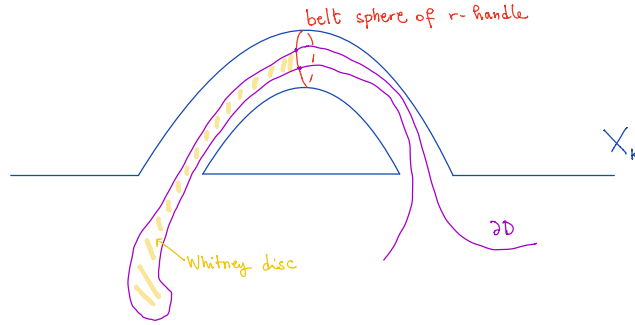

FIGURE 12.7. If the algebraic intersection of boundary of the disc D and the belt sphere of a k -handle is zero we can find a Whitney disc Δ .

In fact, take a loop γ that goes to one intersection point to the other inside ∂D and then goes back to the first intersection point inside the belt sphere. Notice that $\pi_1(\partial X_k) = 1$, in fact M was simply connected and we attached handles of order bigger than 2. Then we can find a disc Δ in ∂X_k that is bounded by γ . Since the dimension of ∂X_k is at least 5 we can approximate Δ relative to the boundary with a smooth embedded disc. Since the codimensions of ∂D and the belt sphere in ∂X_k are both strictly bigger than 2, by a general position argument we can suppose that Δ does not intersect them and is a Whitney disc, therefore we can use the disc Δ to move the belt sphere by an isotopy to remove the two intersection points.

To conclude, just notice that $\partial y = \sum \alpha_j h_j \in H_k(X_k, M)$, where h_j is the homology class of the core of the k -handles which freely generate $H_k(X_k, M)$ and α_j is the intersection number of ∂D and the belt sphere of the j -th k -handle. Therefore, since $\partial y = 0$, we deduce that $\alpha_j = 0$ for all j , which concludes the proof. \square

Recall that we want to prove Proposition 12.8 by induction and we are left to prove the inductive step.

Assume now that Proposition 12.8 holds for some $k < n - 3$, that is for any compact C one can find $U \subseteq W$, U compact manifold with boundary, with ∂U and $V = \overline{W} \setminus \overline{U}$ simply connected such that $C \subseteq \text{Int } U$ and

$$i_* : H_j(U) \rightarrow H_j(W)$$

is an isomorphism for $j < k$ and surjective for all j . Suppose $x \in \ker(i_*)_k$. Then there is a compact set $D \supset U$ such that, if $j : U \hookrightarrow D$ is the inclusion, $j_* x = 0$. By assumption, we can find U' with all the required properties and such that $D \subseteq \text{Int } U'$. Notice that the image of x in $H_k(U')$ must be zero by functoriality. Consider the following commutative diagram:

$$\begin{array}{ccccccc}
 H_{k+1}(X, \partial U) & & & & & & \\
 \downarrow & & & & & & \\
 H_k(\partial U) & \xleftarrow{\partial} & H_{k+1}(V, \partial U) & \xrightarrow{\cong} & H_{k+1}(W, U) & \xrightarrow{\partial} & H_k(U) \\
 \downarrow h_* & & \downarrow & & \downarrow & & \downarrow \\
 H_k(X) & \xleftarrow{\partial'} & H_{k+1}(V, X) & \xrightarrow{\cong} & H_{k+1}(W, U') & \xrightarrow{\partial'} & H_k(U')
 \end{array}$$

where $X = \overline{U'} \setminus \overline{U}$ and the isomorphisms are given by excision. Since $x \in \ker(i_*)_k$, there is $y \in H_{k+1}(W, U)$ such that $\partial y = x$. Notice that both ∂ and ∂' are injective. Therefore, since the

inclusion of x in $H_k(U')$ is zero, it follows that y goes to zero via the map

$$H_{k+1}(W, U) \rightarrow H_{k+1}(W, U').$$

Call z the image of y in $H_k(U)$. Note that $h_*z = 0$, hence there is an element $w \in H_{k+1}(X, \partial U)$ that maps to z via the boundary map.

By Lemma 12.9, applied to X with $M = \partial U$, we can find a properly embedded disc in X attached to ∂U which represents w , and we can add a regular neighbourhood \mathcal{N} of this disc to U . Therefore z maps to 0 in the homology of $\bar{U} := \partial U \cup \mathcal{N}$. Notice that since both $k+1$ and $n-k+1$ are strictly bigger than 2 both $\partial\bar{U}$ and $W \setminus \bar{U}$ are still simply connected. Then

$$\ker i_k^{\bar{U}} \cong \ker i_k^U / (x).$$

We can apply this procedure to a finite set of generators of $\ker i_k^U$ and obtain a manifold \tilde{U} which satisfies the inductive hypothesis for $i = k+1$. \square

Proof of Proposition 12.6. By Proposition 12.8 we can suppose that given a compact $C \subseteq W$ we can find a compact manifold $U \subseteq W$ with simply connected boundary and such that $V \setminus U$ is simply connected as well, $C \subseteq \text{Int } U$ and

$$i_* : H_i(U) \rightarrow H_i(W)$$

is an isomorphism for $i < n-3$ and surjective for all i .

Consider the following diagram with exact rows. Recall that i_k onto implies j_k onto.

$$\begin{array}{ccccccccc} 0 & \longrightarrow & H_{k+1}(V, \partial U) & \xrightarrow{\partial'} & H_k(\partial U) & \xrightarrow{j_k} & H_k(V) & \longrightarrow & 0 \\ & & \downarrow \cong & & \downarrow & & \downarrow & & \\ 0 & \longrightarrow & H_{k+1}(W, U) & \xrightarrow{\partial} & H_k(U) & \xrightarrow{i_k} & H_k(W) & \longrightarrow & 0 \end{array}$$

We see that $\ker i_k \cong \ker j_k$. Notice that $H_{k+1}(W, U) = H_{k+1}(V, \partial U) = 0$ for $k < n-3$ since we know i_k is an isomorphism in this case. Since ∂U is simply connected,

$$H_{n-2}(\partial U) \cong H^1(\partial U) = \text{Hom}(H_1(\partial U), \mathbb{Z}) = 0.$$

Therefore $H_{k+1}(W, U) = H_{k+1}(V, \partial U) = 0$ for $k = n-2$ too. Since V is a non compact n -manifold and $\partial V = \partial U$, we also get $H_n(W, U) \cong H_n(V, \partial U) = 0$.

Hence the only potentially nontrivial one is for $k = n-3$. Since

$$H_{n-3}(\partial U) = H^2(\partial U) \cong \text{Hom}(H_2(\partial U), \mathbb{Z})$$

by the universal coefficient theorem, thanks to the fact ∂U is simply connected, we deduce that $H_{n-2}(V, \partial U)$ is free. There is a compact set D , such that $U \subseteq D \subseteq W$ and $(i_D)_*(\ker i_{n-3}) = 0$ where i_D is the inclusion of U in D . Let U' be a manifold as in Proposition 12.8 such that $D \subseteq \text{Int } U'$. Then if h is the inclusion of U in U' , $h_*(\ker i_{n-3}) = 0$. It follows from the following diagram:

$$\begin{array}{ccccccccc} 0 & \longrightarrow & H_{n-2}(W, U) & \longrightarrow & H_{n-3}(U) & \longrightarrow & H_{n-3}(W) & \longrightarrow & 0 \\ & & \downarrow & & \downarrow h_* & & \downarrow \text{Id} & & \\ 0 & \longrightarrow & H_{n-2}(W, U') & \longrightarrow & H_{n-3}(U') & \longrightarrow & H_{n-3}(W) & \longrightarrow & 0 \end{array}$$

that the first vertical map is the trivial map. Define $V' = \overline{W \setminus U'}$, $M = \partial U$, $N = \partial U'$ and $X = \overline{U' \setminus U}$, so that $\partial X = M \sqcup N$.

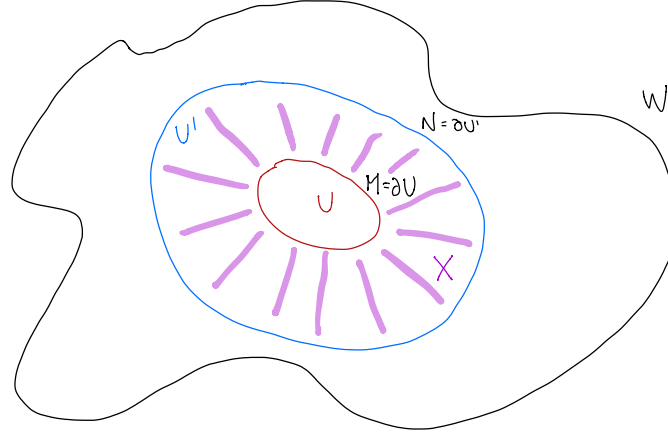

FIGURE 12.8. The manifold X in W .

Call $l_M : M \rightarrow X$ and $l_N : N \rightarrow X$ the inclusions. Then

$$\begin{array}{ccc} H_{n-2}(V, M) & \xrightarrow{\cong} & H_{n-2}(W, U) \\ \downarrow & & \downarrow \\ H_{n-2}(V, X) & \xrightarrow{\cong} & H_{n-2}(W, U') \end{array}$$

shows that the first vertical map is trivial too. Since as before $H_i(V, X)$ and $H_i(V, M)$ are either free (when $i = n - 2$) or trivial (otherwise), this implies that $H^{n-2}(V, X) \cong \text{Hom}(H_{n-2}(V, X), \mathbb{Z})$ and $H^{n-2}(V, M) \cong \text{Hom}(H_{n-2}(V, M), \mathbb{Z})$ and therefore

$$\bar{h}^* : H^{n-2}(V, X) \rightarrow H^{n-2}(V, M)$$

is trivial too. The short exact sequence

$$0 \rightarrow H^{n-3}(V) \rightarrow H^{n-3}(X) \xrightarrow{\delta} H^{n-2}(V, X) \rightarrow 0$$

splits since $H^{n-2}(V, X)$ is free. Call $\alpha : H^{n-2}(V, X) \rightarrow H^{n-3}(X)$ the splitting morphism. Notice that $l_M^* \circ \alpha = 0$. The inclusion $h' : (V', N) \rightarrow (V, X)$ is an excision, and therefore

$$\beta := l_N^* \circ \alpha \circ (h'^*)^{-1} : H^{n-2}(V', N) \rightarrow H^{n-3}(N)$$

is defined. Call $\delta' : H^{n-3}(N) \rightarrow H^{n-2}(V', N)$ the boundary morphism. Then by construction $\delta' \circ \beta = \text{Id}$, i.e. β is a section for the following short exact sequence:

$$0 \rightarrow H^{n-3}(V') \rightarrow H^{n-3}(N) \xrightarrow{\delta'} H^{n-2}(V', N) \rightarrow 0.$$

Moreover the image of β is contained in $l_N^*(\ker l_M^*)$ since the image of α is in the kernel of l_M^* .

LEMMA 12.10. *Capping with the fundamental class:*

$$- \frown [N] : H^{n-k-1}(N) \rightarrow H_k(N)$$

sends $l_N^*(\ker(l_M^*)^{n-k-1})$ isomorphically onto $\ker((l_N)_*)_k$.

Proof. Consider the following commutative diagram with exact rows:

$$\begin{array}{ccccc} H^{n-k-1}(X) & \xrightarrow{l^*} & H^{n-k-1}(\partial X) & \xrightarrow{\delta} & H^{n-k}(X, \partial X) \\ \downarrow \frown \nu & & \downarrow \frown \mu & & \downarrow \\ H_{k+1}(X, \partial X) & \xrightarrow{\partial} & H_k(\partial X) & \xrightarrow{l_*} & H_k(X) \end{array}$$

where $\nu \in H_n(X, \partial X)$, $\mu \in H_{n-1}(\partial X)$ are the respective the fundamental classes. Notice that

$$H_*(\partial X) = H_*(N) \oplus H_*(M),$$

the fundamental classes μ and ν are related by:

$$\mu = \partial\nu = [N] - [M]$$

and

$$\begin{aligned} l_* &= (l_N)_* - (l_M)_* \\ l^* &= (l_N)^* - (l_M)^*. \end{aligned}$$

Since $-\frown \nu$ is an isomorphism,

$$l^*(H^{n-k-1}(X)) \frown \mu = \ker(l_*).$$

Since the restriction of $-\frown \mu$ to N equals $-\frown [N]$, it follows that $l^*(H^{n-k-1}(X)) \cap H^{n-k-1}(N)$ is mapped isomorphically by $-\frown [N]$ onto $\ker(l_*) \cap H_k(N)$. But

$$l^*(H^{n-k-1}(X)) \cap H^{n-k-1}(N) = l_N^*(\ker l_M^*)$$

and similarly

$$\ker l_* \cap H_k(N) = \ker((l_N)_*)_k.$$

□

Since $\text{Im } \beta$ is a free direct summand in $H^{n-3}(N)$, it follows that $B = \text{Im } \beta \frown [N]$ is a free direct summand of $H_2(N)$ contained in $\ker((l_N)_*)_2$. Recall that $V = V' \cup X$, $X \cap V' = N$ and that V, V', N are simply connected. Then Seifert-Van Kampen theorem implies that X is simply conneted as well. By the Hurewicz theorem

$$\pi_2(N) \xrightarrow{\sim} H_2(N)$$

and

$$\pi_2(X) \xrightarrow{\sim} H_2(X).$$

Since $(l_N)_*B = 0$ this means that an element in B is represented by a map $f : S^2 \rightarrow N$ which is nullhomotopic in X . If $n > 6$ by a general position argument we can suppose there is a disc D^3 smoothly embedded in X such that the boundary of the disc is a representative for f in $\pi_2(N)$, while if $n = 6$ we need to use once again the Whitney trick. Taking a regular neighbourhood of the disc in X we find a 3-handle $D^3 \times D^{n-3}$. We can apply this procedure to a basis $\{b_j\}_{j=1}^h$ for B . If we add these handles $\{H_j\}_{j=1}^h$ to V' we obtain new manifolds $\bar{X} = X \setminus \bigcup_{j=1}^h \text{Int}(H_j)$, $\bar{V} = V' \cup \bigcup_{j=1}^h H_j$ and $\bar{N} = \bar{X} \cap \bar{V}$.

Recall that $H_k(N) \cong H_k(V')$ for $k < n - 3$ and that B is a free direct summand of $H_2(N)$, then it is possible to show that $H_k(\bar{V}) \cong H_k(V')$ for $k \neq 2, 3$ and

$$0 \rightarrow H_3(V') \rightarrow H_3(\bar{V}) \rightarrow \bigoplus_{j=1}^h \mathbb{Z}h_j \xrightarrow{\bar{\delta}} H_2(V') \rightarrow H_2(\bar{V}) \rightarrow 0$$

where h_j is the attaching sphere of the handle H_j , hence $\bar{\delta}$ is injective. Therefore $H_k(V') \cong H_k(\bar{V})$ for $k \neq 2$ and

$$H_2(\bar{V}) \cong H_2(V')/r_*(B) \cong H_2(N)/B,$$

where $r_* : H_2(N) \rightarrow H_2(V')$. Recall that r_* is an isomorphism.

Notice that $\bar{N} \cup \{\text{cocores of } H_j\}$ is homotopically equivalent to N with some D^3 attached, which are the cores of the H_j 's. By the Mayer-Vietoris sequence and the fact that B is free,

$$H_k(N) \cong H_k(N \cup \{\text{cores of the handles}\})$$

for $k \neq 2$ and

$$H_2(N \cup \{\text{cores of the handles}\}) \cong H_2(N)/B.$$

Since attaching the cocores of the H_j 's to \bar{N} can only modify the homology groups of \bar{N} in dimension $n-3$ and $n-4$, when $n > 6$ it is a consequence of Poincaré duality and the universal coefficient theorem that $H_j(N) \cong H_j(\bar{N})$ for $j \neq 2, n-3$, and $H_2(\bar{N}) \cong H_2(N)/B$. The case $n = 6$ follows from Lemma 5.6 in [KM63b]. By the same arguments we applied to $(V, \partial U)$, it follows that $H_i(\bar{V}, \bar{N}) = 0$ for $i \neq 2$ and $H^{n-2}(\bar{V}, \bar{N})$ is free and we have the following short exact sequence:

$$0 \rightarrow H^{n-3}(\bar{V}) \rightarrow H^{n-3}(\bar{N}) \rightarrow H^{n-2}(\bar{V}, \bar{N}) \rightarrow 0.$$

Notice that the image of B via the Poincaré duality isomorphism $H_2(N) \rightarrow H^{n-3}(N)$ is indeed the image of β . Hence

$$H^{n-3}(\bar{N}) \cong H^{n-3}(N)/\text{Im } \beta.$$

Recall that $H^{n-3}(V') \cong H^{n-3}(N)/\text{Im } \beta$ too, and

$$H^{n-3}(\bar{V}) \cong H^{n-3}(V').$$

Therefore $H^{n-3}(\bar{V})$ and $H^{n-3}(\bar{N})$ are isomorphic groups. Since they are finitely generated and we know that $H^{n-2}(\bar{V}, \bar{N})$ is free, it follows that $H^{n-2}(\bar{V}, \bar{N}) = 0$. By the universal coefficient theorem $H_i(\bar{V}, \bar{N}) = 0$ for all i and it follows that $\bar{U} = U \cup \bar{X}$ is a compact manifold with simply connected boundary and

$$H_*(\bar{U}) \rightarrow H_*(W)$$

is an isomorphism. Since the compact set C was contained in $\text{Int } U$ it will be also contained in $\text{Int } \bar{U}$. This proves Proposition 12.6. \square

12.5. The h-cobordism theorem

As an interesting consequence of Theorem 12.2 we obtain an h -cobordism theorem for open manifolds.

Definition 12.11. Two oriented connected open manifolds M_1 and M_2 are called *h-cobordant* if there exists a manifold with boundary V with $\partial V = M_1 \sqcup (-M_2)$ such that the inclusions $M_i \hookrightarrow V$ are homotopy equivalences.

THEOREM 12.12. *Let M_1, M_2 satisfy the hypothesis of Theorem 12.2 and let V be a h-cobordism between them which is simply connected at ∞ . If N_1 and N_2 are the manifolds given by Theorem 12.2 for M_1 and M_2 respectively then they are h-cobordant.*

Proof. N_1 and N_2 are compact manifolds with boundary. Using a collar of the boundary of N_i we can embed N_i into M_i . Using now a collar C of the boundary of V we get embeddings of $N_i \times I \subseteq V$, with $N_i \times I \cap \partial V = N_i \times \{0\}$. We can join $N_1 \times \{1\}$ to $N_2 \times \{1\}$ by an arc in the interior of $V \setminus C$ and thickening the arc we get a compact manifold U , $\partial U = N_1 \cup W \cup N_2$ and $\partial W = \partial N_1 \sqcup \partial N_2$.

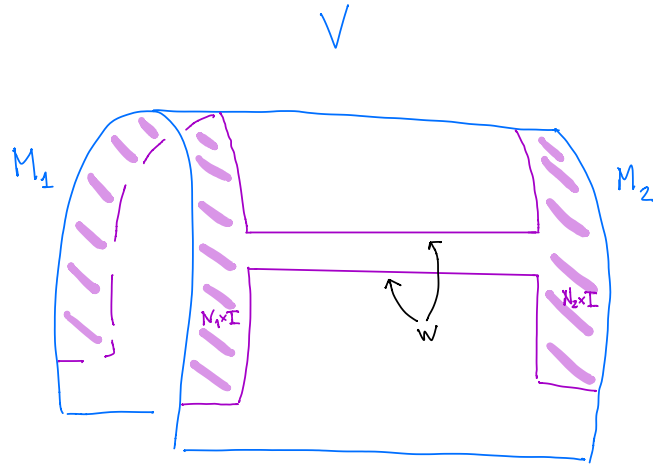

FIGURE 12.9. The manifold V .

Then, similarly to what we did for the proof of Theorem 12.2 we can enlarge U to get $\bar{V} \subseteq V$, $V \cong \text{Int } \bar{V}$ just by adding handles far from N_1 and N_2 . Therefore $\partial \bar{V} = N_1 \cup \bar{W} \cup N_2$, $\partial \bar{W} = \partial N_1 \sqcup \partial N_2$. From the diagram:

$$\begin{array}{ccc} N_i & \longrightarrow & \bar{V} \\ \downarrow & & \downarrow \\ M_i & \longrightarrow & V \end{array}$$

it follows that $N_i \rightarrow \bar{V}$ is a homotopy equivalence since all other three maps are. We are only left with showing that \bar{W} is a h -cobordism between N_1 and N_2 . Now Poincaré-Lefschetz duality gives

$$H^*(\bar{V}, N_1) \cong H_*(\bar{V}, N_2 \cup \bar{W})$$

and similarly exchanging N_1 and N_2 . Since $N_i \rightarrow \bar{V}$ is a homotopy equivalence the left-hand side must be trivial. Notice that in

$$H_*(N_i) \xrightarrow{i_*} H_*(N_i \cup \bar{W}) \xrightarrow{j_*} H_*(\bar{V})$$

both $j_* i_*$ and j_* are isomorphisms, hence i_* is as well. Therefore $0 = H_*(N_i \cup \bar{W}, N_i) \cong H_*(\bar{W}, \partial N_i)$ by excision. Since both \bar{W} and ∂N_i are simply connected it follows by the Hurewicz theorem that $\partial N_i \rightarrow \bar{W}$ is a homotopy equivalence and therefore \bar{W} is an h -cobordism. \square

The following is a direct corollary of the above using the h -cobordism theorem [Sma62b].

COROLLARY 12.13. *Let M_1, M_2, V as in Theorem 12.12 and suppose M_1 and M_2 are simply connected. Then M_1 and M_2 are isomorphic.*

Part V

Piecewise-linear manifolds

Piecewise linear manifolds

Arunima Ray

In the next section we will state and prove the stable homeomorphism theorem and the annulus theorem. One remarkable aspect of these proofs is that they require the use of piecewise-linear (PL) structures, as well as some deep theorems from the theory of PL manifolds.

13.1. Definitions

In this section we introduce PL manifolds. Similar to how we define smooth structures on manifolds, we first establish a notion of piecewise-linear maps between subsets of Euclidean space (with its standard structure).

Definition 13.1. An r -simplex in \mathbb{R}^n is the convex hull of $r + 1$ linearly independent points. Let $K \subseteq \mathbb{R}^n$ be a compact subset. An injective map $f: K \hookrightarrow \mathbb{R}^n$ is said to be *piecewise-linear* if K can be written as a finite union of simplices with each mapped affinely by f .

Next we apply Definition 13.1 to define piecewise-linear structures on general topological manifolds.

Definition 13.2. Let M be an n -manifold. A *piecewise-linear (PL) structure* on M is a family $\mathcal{F} = \{\phi: \Delta^n \hookrightarrow M \mid \Delta^n \subseteq \mathbb{R}^n \text{ a standard simplex}\}$ such that

- (1) every point $p \in M$ has a neighbourhood of the form $\phi(\Delta^n)$ for some $\phi \in \mathcal{F}$, called a PL chart;
- (2) for $\phi, \psi \in \mathcal{F}$, the composition $\psi^{-1}\phi: \phi^{-1}\psi(\Delta^n) \rightarrow \mathbb{R}^n$ is piecewise-linear;
- (3) \mathcal{F} is maximal with respect to the above two properties.

In the first item, by invariance of domain, if p is in the interior of M , then $p \in \phi(\overset{\circ}{\Delta}^n)$, while if $p \in \partial M$, then $p \in \phi(\partial\Delta^n)$.

Definition 13.3. For $m \leq n$, let M^m and N^n be topological manifolds with PL structures \mathcal{F} and \mathcal{G} respectively. An embedding $h: M \hookrightarrow N$ is said to be *piecewise-linear* if for all $p \in M$, there exists a PL chart $\phi: \Delta^m \hookrightarrow M$ with $p \in \phi(\Delta^m)$ and $\psi: \Delta^n \hookrightarrow N$ with $h(p) \in \psi(\Delta^n)$ such that

$$\psi^{-1}h\phi: \phi^{-1}(h^{-1}(\psi(\Delta^m))) \rightarrow \mathbb{R}^n$$

is PL in the sense of Definition 13.1. Here note that $\phi^{-1}(h^{-1}(\psi(\Delta^m))) \subseteq \mathbb{R}^m$ is compact.

For $m = n$, the above definition says that $h: M \hookrightarrow N$ is a *piecewise-linear embedding* if whenever $\phi \in \mathcal{F}$, we have that $h\phi \in \mathcal{G}$.

A homeomorphism $h: M \rightarrow N$ is said to be a *PL-homeomorphism* if h is a PL embedding. This implies that h^{-1} is a PL embedding. For a proof of this, see Hudson [Hud69].

Here are some properties of PL manifolds. For a vertex v we define the *star* $\text{St}(v)$ as the union of all simplices which have v as a vertex, and the *link* $\text{Lk}(v)$ as all the faces of $\text{St}(v)$ not containing v .

- (1) A compact n -manifold M has a PL-structure if and only if M has a triangulation such that the link of every vertex v is equivalent to a PL sphere S^{n-1} (if $v \in \text{Int } M$) or a PL disc D^{n-1} (if $v \in \partial M$). Here equivalent means that there exists a subdivision such

that the result is simplicially homeomorphic. This is due to Dedecker [Ded62] and also appears in Hudson's book [Hud69].

- (2) The Cairns-Whitehead theorem says that every smooth manifold has a PL structure, unique up to PL homeomorphism. Further, every diffeomorphism of smooth manifolds determines a PL homeomorphism of the corresponding PL manifolds.
- (3) The compositions of PL embeddings are PL. This implies that PL-homeomorphism is an equivalence relation.
- (4) A PL structure \mathcal{F} on M induces a PL structure $\partial\mathcal{F}$ on ∂M .
- (5) Two PL manifolds with PL homeomorphic boundaries glue together to give a PL manifold.

13.2. Theorems from PL topology

We will need to make use of the following deep theorems on PL manifolds. We will not be going into the proofs at this stage.

THEOREM 13.4 (PL Poincaré conjecture). *Let $n \geq 5$. If M^n is a closed PL manifold homotopy equivalent to S^n , then M is PL-homeomorphic to S^n .*

The PL Poincaré conjecture for dimensions at least 5 is due to Smale. Initially there was a category losing version, i.e. PL input, topological output, due to Stallings. Stallings also excluded dimensions 5 and 6. But these defects were soon rectified. Zeeman extended Stallings' techniques to dimension 6, but dimension 5 came from Smale, at the same time as he proved the stronger PL input, PL output version in all dimensions at least five. Smale also proved the smooth input, PL output version.

The purely topological Poincaré conjecture, with topological input and output, in all dimensions at least five, is due to Newman. His proof used engulfing, as did Stallings and Zeeman's initial PL proofs. Kirby-Siebenmann's technology gave an alternative proof of the purely topological version in dimension at least 6.

THEOREM 13.5 (Structures on $S^n \times \mathbb{R}$). *Let $n \geq 4$. There is a unique PL structure on $S^n \times \mathbb{R}$. That is, if M is a PL manifold homeomorphic to $S^n \times \mathbb{R}$, then M is PL homeomorphic to $S^n \times \mathbb{R}$.*

This is due to Browder [Bro65] for $n \geq 5$ and to Wall [Wal67] for $n = 4$. The proofs use Siebenmann's thesis [Sie65], results of Wall [Wal64], and Stallings [Sta62a], and notably the PL Poincaré conjecture mentioned above.

The last deep theorem we will need from PL topology is due to Hsiang-Shaneson [HS69] and Wall [Wal69].

THEOREM 13.6 (Homotopy tori). *Let $n \geq 5$. Let M^n be a closed PL manifold, and let $f: T^n \rightarrow M$ be a homotopy equivalence. Then there is a finite cover of both such that the lift $\tilde{f}: \tilde{T}^n \rightarrow \tilde{M}$ is homotopic to a PL homeomorphism.*

The finite cover of the torus in the domain is also PL-homeomorphic to the torus. We will explain this theorem in a later chapter.

13.3. Handle decompositions

We shall later need the notion of handle decompositions of manifolds. An n -dimensional, index k handle is a copy of $B^k \times B^{m-k}$, and its *attaching region* is the part $\partial B^k \times B^{m-k}$ of its boundary, see Fig. 13.1. The *core* of a handle is $B^k \times \{0\}$. Given a manifold M^m and a topological embedding $\psi: \partial B^k \times B^{m-k} \hookrightarrow \partial M$ we consider $M \cup_\psi (B^k \times B^{m-k})$, the manifold obtained by attaching a k -handle to M along ψ .

A (topological) handle decomposition of a manifold M is a decomposition $M = \bigcup h_i^{k_i}$ into union of handles attached along their attaching regions via topological embeddings as described

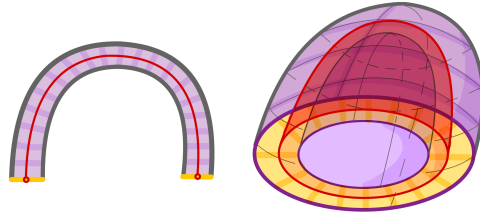

FIGURE 13.1. The 2-dimensional 1-handle $B^1 \times B^1$ attaches along the yellow $S^0 \times B^1$, and the 3-dimensional 2-handle $B^2 \times B^1$ along the yellow $S^1 \times B^1$. Their cores are shown in red.

above. It is said to be *piecewise linear* or *smooth* if the attaching maps are PL or smooth embeddings respectively. In the latter case, we must also smooth the corners to obtain a smooth manifold after attaching a handle, but this can be done in an essentially unique way.

Remark 13.7. Every closed topological manifold has a topological handle decomposition, unless it is non-smoothable and has dimension $m = 4$. For $m > 6$ we will show how to do this later, following [KS77b, Essay III]. For $m = 5$, this is due to Quinn [Qui82a]. Smooth manifolds have smooth handle decompositions. This suffices for the existence of handle decompositions in dimension ≤ 3 and for smooth 4-manifolds. To see that nonsmoothable 4-manifolds do not have topological handle decompositions, observe that the handle attaching maps are all 3-dimensional and can be isotoped to be smooth embeddings. Consequently a topological handle decomposition would yield a smooth handle decomposition, and thereby a contradiction.

There are also relative handle decompositions, but we will not go into this for the moment.

Triangulations yield handle decompositions. Explicitly, for a k -simplex σ in a triangulation T of a manifold M , we obtain a handle of index k given by

$$\text{St}(\hat{\sigma}) \subseteq T''$$

where T'' is the second barycentric subdivision of T , $\hat{\sigma}$ is the barycentre of σ , and St denotes the star. See Fig. 13.2 for an example and [Hud69, p. 233] for further details.

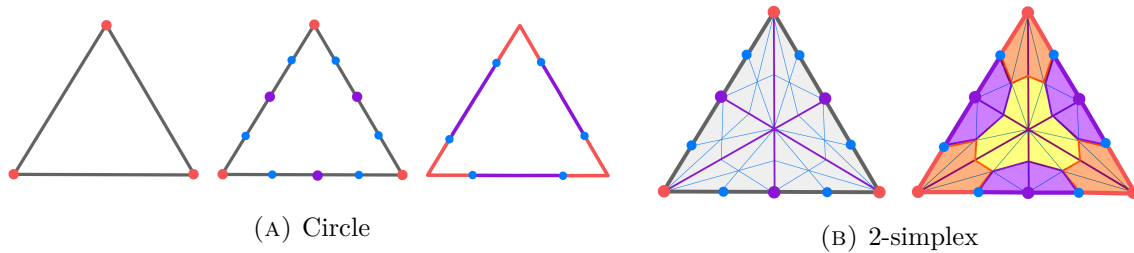

FIGURE 13.2. Construction of a handlebody decomposition from a triangulation. 0-handles are coloured orange, 1-handles are purple, and the 2-handle is yellow.

The Engulfing Theorem and uniqueness of PL structures on \mathbb{R}^n for $n \geq 5$

Diego Santoro

14.1. Introduction

In these notes we prove that for $n \geq 5$ there exists a unique PL structure on \mathbb{R}^n up to PL isomorphism. The proof will be mostly based on the so called Engulfing Theorem, that is presented in the second section. In the first section we recall some basic notions and results of PL theory.

Conventions. We will usually omit the prefix PL: so for example manifold stands for PL manifold, isomorphism for PL isomorphism and so on. We will explicitly state the category in which we are working when it is necessary. When not explicitly stated, manifolds are supposed to be without boundary, and they can be compact or not.

14.2. Basic notions and useful theorems in PL theory

In this section we recall some definitions and results regarding PL theory that will be needed later. This section will contain no proof. We refer to [RS72], [Zee63] and [Buo] for details and proofs.

Definition 14.1. Let $n \geq 0, m \geq 0$ be two natural numbers. An n -simplex A in some Euclidean space E^m is the convex hull of n linearly independent points, called *vertices*. A simplex B spanned by a subset of vertices of A is called a *face* of A , and we write $B < A$. The number n is called the *dimension* of A .

Definition 14.2. A (locally finite) *simplicial complex* K is a collection of simplices in some Euclidean space E , such that:

- if $A \in K$ and B is a face of A then $B \in K$.
- If $A, B \in K$ then $A \cap B$ is a common face, possibly empty, of both A and B .
- Each simplex of K has a neighbourhood in E which intersects only a finite number of simplices of K .

We define the *dimension* of K to be the maximal dimension of a simplex in K .

Given a simplicial complex K we denote

$$|K| = \bigcup_{A \in K} A$$

its underlying topological space, and we call it a *Euclidean polyhedron*.

We say that K' is a *subdivision* of K if $|K'| = |K|$ and each simplex of K' is contained in some simplex of K .

Definition 14.3. Let K, L be two simplicial complexes. We say that a map $f: K \rightarrow L$ is *simplicial* if for each simplex $A \in K$ its image $f(A)$ is a simplex in L and the restriction of f on A is linear. We say that f is *piecewise linear*, abbreviated PL, if there exists a subdivision K' of K such that f maps each simplex of K' linearly into some simplex of L .

Remark 14.4. Notice that the map f in the previous definition is defined on the Euclidean polyhedron $|K|$ and $|L|$, but we write $f: K \rightarrow L$ as an abuse of notation to stress the dependence on the simplicial complexes.

Remark 14.5. Notice also that in the definition of PL map we do not ask for the map $f: |K'| \rightarrow |L|$ to be simplicial. However it is true that if K and L are finite complexes and $f: |K| \rightarrow |L|$ is a PL map, then there exists subdivision K' of K and L' of L such that $f: K' \rightarrow L'$ is simplicial.

Definition 14.6. A *triangulation* of a topological space X is a simplicial complex K and a homeomorphism $t: |K| \rightarrow X$. A *polyhedron* is a pair (P, \mathcal{F}) , where P is a topological space and \mathcal{F} is a maximal collection of PL compatible triangulations; that is to say, given $t_1: |K_1| \rightarrow P$ and $t_2: |K_2| \rightarrow P$ in \mathcal{F} we have that $t_1 \circ t_2^{-1}: K_2 \rightarrow K_1$ is a PL isomorphism.

Given X_1, X_2 two polyhedra, we say that $f: X_1 \rightarrow X_2$ is a PL map if there exists triangulations of X_1 and X_2 such that f is PL with respect to these triangulations.

Fact: A theorem of Runge ensures that an open set U of a simplicial complex K , or more precisely of $|K|$, can be triangulated, i.e. underlies a locally finite simplicial complex, in such a way that the inclusion map is PL. Furthermore such a triangulation is unique up to a PL isomorphism. For a proof see [AH35].

By virtue of the previous fact, it makes sense to give the following definition.

Definition 14.7. A (PL) manifold M of dimension n is a polyhedron such that every point $x \in M$ has a neighbourhood (PL) isomorphic to an open set in $\mathbb{R}_{\geq 0}^n = \{x \in \mathbb{R}^n | x_n \geq 0\}$.

Remark 14.8. In the previous definition the open sets in M and the open sets in $\mathbb{R}_{\geq 0}^n$ are endowed with the PL structure induced by the given PL structure on M and the standard PL structure on $\mathbb{R}_{\geq 0}^n$ respectively.

We denote with ∂M the set of points that are mapped to the boundary of $\mathbb{R}_{\geq 0}^n$ by some (and hence all) such local isomorphisms, and call it the *boundary* of M . We denote its complement with $\text{Int}(M)$ and call it the *interior* of M .

Recall that, unless explicitly stated, in these notes we will suppose that our manifolds are without boundary.

14.2.1. Regular neighbourhoods.

Definition 14.9. Let P be a polyhedron. A subset $P_0 \subseteq P$ is a *subpolyhedron* if there exists a triangulation of P which restricts to a triangulation of P_0 .

Definition 14.10. Let K be a simplicial complex, and let $K_0 \subseteq K$ a subcomplex. Suppose that there exists a simplex $A = v * B \in K$ (i.e. A is the cone with vertex v and base the face B) where $v \in A$ is a vertex such that $K = K_0 \cup A$ and $K_0 \cap A = v * \partial B$. In this case we say that there is a *elementary simplicial collapse* from K to K_0 , and we denote it by $K \xrightarrow{e.s.} K_0$. A *simplicial collapse* is a finite number of elementary simplicial collapses, and if K has a simplicial collapse to K_0 we denote this by $K \xrightarrow{s} K_0$.

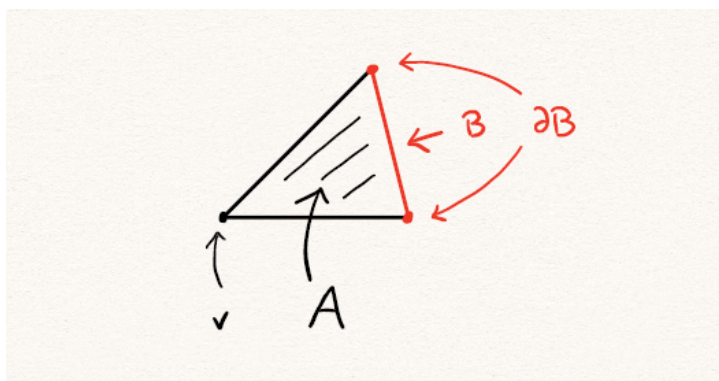

FIGURE 14.1

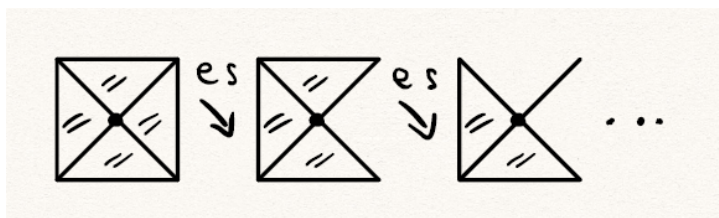

FIGURE 14.2. A sequence of elementary simplicial collapses.

Definition 14.11. Let P be a polyhedron, and let $P_0 \subseteq P$ a subpolyhedron. Suppose that there exists, for some natural number m , a (PL) m -ball $B \subseteq P$ such that $P = P_0 \cup B$ and $K_0 \cap B$ is a (PL) $(m - 1)$ -ball in ∂B . In this case we say that there is an *elementary collapse* from K to K_0 , and we denote it by $K \xrightarrow{e} K_0$. A collapse is a finite number of elementary collapses, and if K collapses to K_0 we denote this by $K \searrow K_0$.

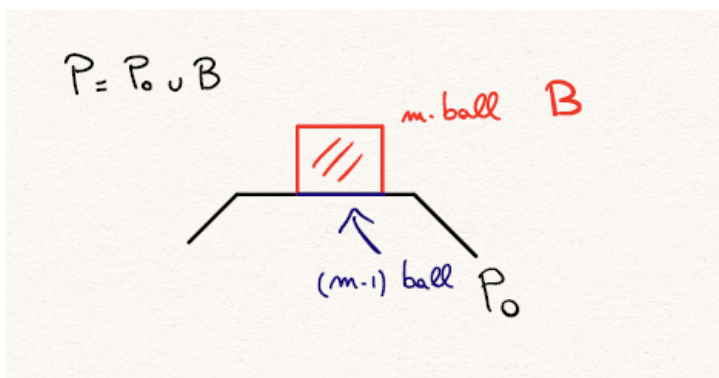

FIGURE 14.3

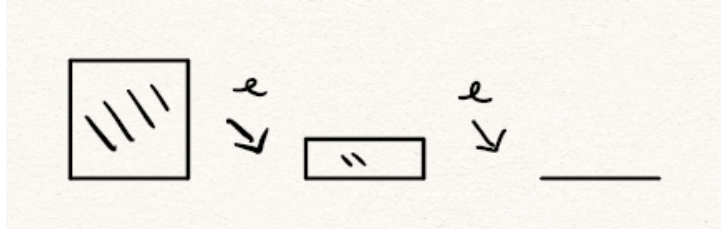

FIGURE 14.4. A sequence of elementary collapses.

Remark 14.12. The difference between the definition of collapse and simplicial collapse lies in the fact that a polyhedron does not have a “canonical” triangulation. It is obvious that a simplicial collapse is a collapse, but it is not true that if $P \searrow P_0$ then for any triangulation (K, K_0) of the pair (P, P_0) we have a simplicial collapse $K \searrow K_0$. It is however true that it is possible to find a subdivision (K', K'_0) of (K, K_0) such that $K' \searrow K'_0$.

Definition 14.13. Let M be a closed (PL) n -manifold and let X be a subpolyhedron in M . A regular neighbourhood of X in M is any subpolyhedron N in M such that:

- N is an n -manifold with boundary,
- N is a topological neighbourhood of X in M ,
- $N \searrow X$

For proofs of the following results we refer to [RS72].

THEOREM 14.14. *Any second derived neighbourhood of X in M is a regular neighbourhood of X in M . Moreover any two regular neighbourhoods N_1, N_2 of X in M are ambiently isotopic in M , keeping fixed any arbitrary regular neighbourhood $N \subseteq N_1 \cap N_2$ and the complement of any arbitrary open set $U \supseteq N_1 \cup N_2$.*

LEMMA 14.15. *Suppose X, Y are two subpolyhedra in a manifold M , and suppose that $X \searrow Y$. Then any regular neighbourhood of X is a regular neighbourhood of Y .*

As a corollary of the previous theorem and lemma we have the following.

COROLLARY 14.16. *Suppose X, Y are subpolyhedra in a manifold M , and suppose that $X \searrow Y$. Then any two regular neighbourhoods N_X and N_Y of X and Y are ambiently isotopic in M , via an isotopy keeping fixed any arbitrary regular neighbourhood of Y in $N_X \cap N_Y$ and the complement of any arbitrary open set $U \supseteq N_X \cup N_Y$.*

One way to construct regular neighbourhood is the following. Suppose that X is a subpolyhedron of a closed manifold M and consider a triangulation (T, T_0) of the pair (M, X) .

Define $f_X: T \rightarrow [0, 1]$ to be the unique simplicial map defined by mapping each vertex of T_0 to 0 and the other vertices to 1. We say that T_0 is *full* in T if $f_X^{-1}(0) = T_0$. If T_0 is full in M then for any $t \in (0, 1)$ the preimage $f_X^{-1}([0, t])$ is a regular neighbourhood of X in M .

Remark 14.17. It can happen that T_0 is not full in T , but it is always possible to find a subdivision (T', T'_0) of (T, T_0) such that T'_0 is full in T' . Also notice that $f_X^{-1}(1)$ is always full in T .

Since we will work also with non compact manifolds and non compact polyhedra it is important to mention that regular neighbourhoods can be defined also in this setting and analogous results hold. The main difference is that also infinite sequences of elementary collapses are allowed. We refer to the paper [Sco67] for details.

Of course, in case of infinite regular neighbourhoods it is not possible in general to have uniqueness up to ambient isotopy with compact support. In any case the following lemma will be enough for our purposes.

LEMMA 14.18. *Suppose that X, Y are subpolyhedra of M and suppose that $X \searrow Y$ (finite collapse). If $Y \subseteq U$, where U is an open set in M , then there exists an ambient isotopy of M with compact support that maps X in U .*

We end this subsection stating a lemma that we will play a key role in the following section.

LEMMA 14.19. *Suppose that $P_0 \subseteq P$ are compact polyhedra and that $P \searrow P_0$. Also suppose that $S \subseteq P$ is a subpolyhedron. Then there exists a subpolyhedron $S^+ \supseteq S$ such that $P \searrow P_0 \cup S^+$ and $\dim S^+ \leq \dim S + 1$.*

14.2.2. General position. We need the following theorem, which roughly states that it is possible, with a slight perturbation, to promote a continuous map to a PL map that is “generic”, in the sense that the image of this map has transverse self-intersections. Moreover it is possible to keep the map unchanged on a subpolyhedron on which it is already PL and generic.

To quantify the amount of perturbation, we will fix any metric compatible with the topology of our polyhedron. If (Z, d) is a metric space, we say that a map $f: Y \times I \rightarrow Z$ is an ε -homotopy if $d(f(y, 0), f(y, t)) < \varepsilon$ for all $y \in Y$ and $t \in I$.

THEOREM 14.20. *Let $P_0 \subseteq P^p$ be a subpolyhedron with $cl(P \setminus P_0)$ compact. Let $f: P \rightarrow M^m$ be a closed and continuous map with $p \leq m$ such that f is a PL embedding when restricted to P_0 , and let $\varepsilon > 0$ be given. Then there is an ε -homotopy rel P_0 from f to a map g and a triangulation T of P such that:*

- for every simplex $A \in T$ the restriction $g|_A$ is a PL embedding;
- for every $A, B \in T$, we have that $g^{-1}(g(B)) \cap A = (A \cap B) \cup S(A, B)$, where $S(A, B)$ is a subpolyhedron of A of dimension

$$\dim(S(A, B)) \leq \dim A + \dim B - m.$$

Here are some comments to clarify the second condition in Theorem 14.20. The set $g^{-1}g(B) \cap A$ is by definition the set of points in A that share their image with some point in B . Since g is an embedding when restricted to any simplex, this set parametrises the intersection between $g(A)$ and $g(B)$ in M . The second condition then asks that this intersection (apart from the obvious set $g(A \cap B)$) is a polyhedron and is generic. The following figures should help the comprehension of this request.

Remark 14.21. In general it is false that $A \cap B$ and $S(A, B)$ are disjoint, since we require $S(A, B)$ to be a subpolyhedron. For instance, in the case depicted in Figure 14.6 the set $S(A, B)$ contains also two points in $A \cap B$.

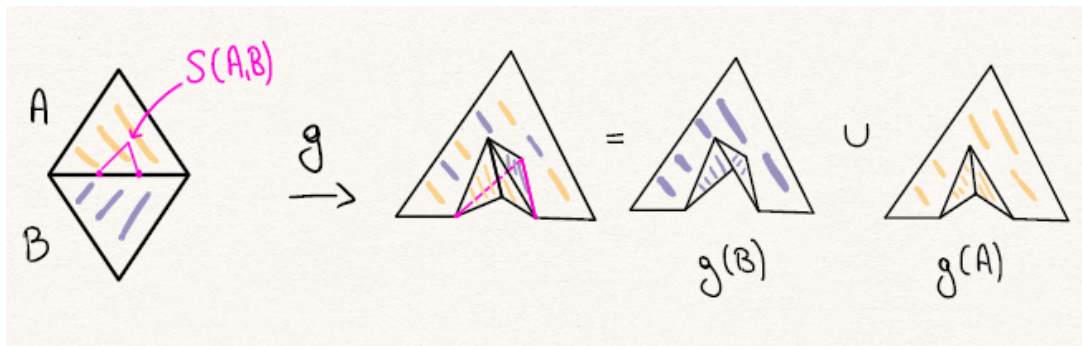

FIGURE 14.6

If we let A, B vary we can define the *singular set* of g :

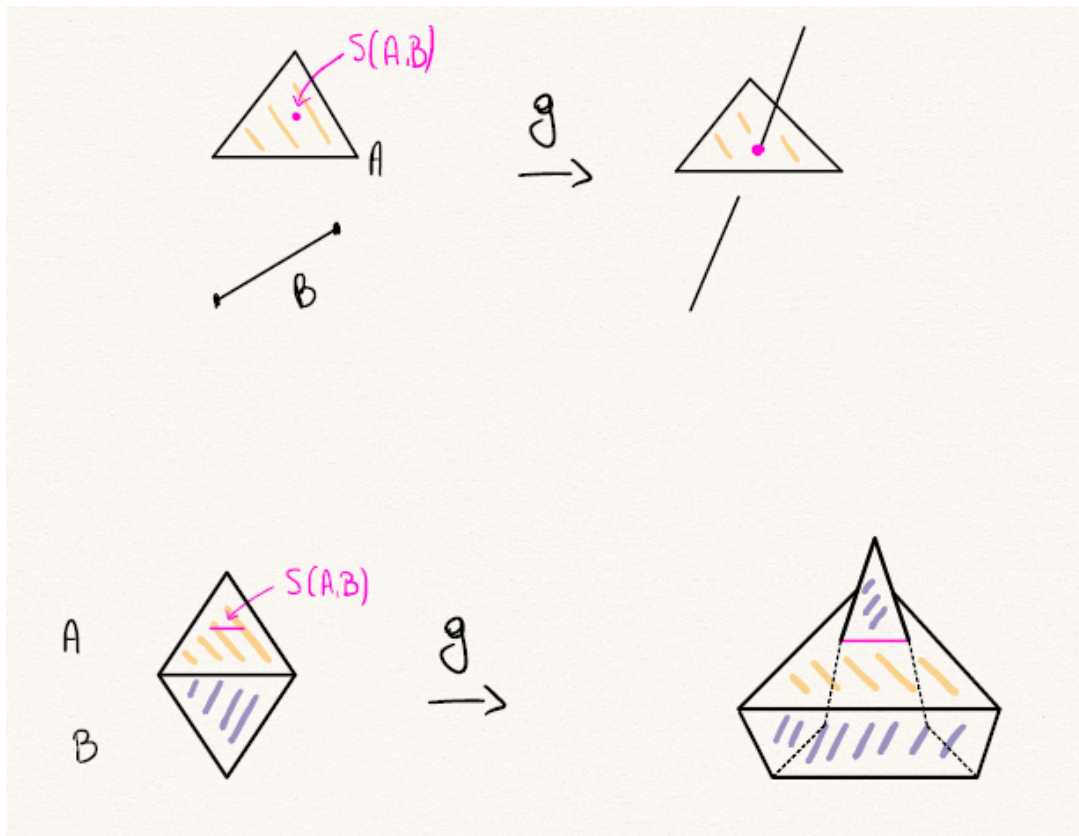

FIGURE 14.5

$$S(g) = \bigcup_{A,B \in T} S(A,B).$$

It is not difficult to prove that $S(g)$ is a subpolyhedron of dimension at most $2p - m$ and that $S(g) = cl\{p \in P \mid g^{-1}g(p) \neq p\}$. In particular g is injective on $P \setminus S(g)$.

Details about general position arguments can be found in [Zee63] and [RS72].

In the following section we will need to use some collapses in the domain of a PL map to induce collapses on the image. If we have a PL embedding of course it is possible to mirror such a collapse on the image of the map. In general we are able to do so if the collapse takes place away from the singular set of the map.

LEMMA 14.22. *Let P, Q be two polyhedra. Let $g: P \rightarrow Q$ be a PL map and suppose that $S \supseteq S(g)$ is a subpolyhedron of P that contains the singular set of g . Then if $P \searrow S$ also $g(P) \searrow g(S)$.*

For a proof of the previous lemma we refer to [Zee63].

14.3. The Engulfing Theorem

In this section we will state and prove the main theorem of these notes, the Engulfing Theorem. The sense of this theorem is to promote an homotopical, and hence algebraic, statement into a geometric one. As an example, consider the following question.

Question 14.23. Suppose that C is a compact set in a manifold M^n such that the inclusion $C \hookrightarrow M$ is nullhomotopic. Is C contained in an n -ball?

Of course if a set is contained in a ball then its inclusion is nullhomotopic, but at a first sight it is very difficult to give an answer to Question 14.23. As a consequence of the Engulfing Theorem we will improve our understanding of this problem and have a satisfying partial answer to this question.

There are several versions of the Engulfing Theorem, which is a technique more than a theorem in itself. We will present here the Stallings' version of the theorem [Sta62b], which is the one that suits our needs.

THEOREM 14.24 (Stallings' Engulfing Theorem). *Let M^n be a PL manifold, U an open subset of M , P a subpolyhedron of M of dimension p . Suppose that:*

- (M, U) is p -connected;
- $P \cap (M \setminus U)$ is compact;
- $p \leq n - 3$.

Then there is a compact $E \subseteq M$, and there is an isomorphism $h: M \rightarrow M$, such that

$$P \subseteq h(U) \quad \text{and} \quad h|_{M \setminus E} = \text{Id}|_{M \setminus E}.$$

Recall that (M, U) is said to be p -connected if the relative homotopy groups $\pi_i(M, U)$ all vanish for $i \leq p$. Notice that, since the polyhedron P has dimension p , the hypothesis of p -connectedness is the sufficient algebraic condition to deduce that it is possible to homotope the remaining part of P inside the open subset U , as the following lemma proves.

LEMMA 14.25. *Suppose that P is a subpolyhedron of dimension p of a manifold M . Suppose that $P_0 \subseteq P$ is a subpolyhedron of P and that U is an open set in M such that $P_0 \subseteq U$ and (M, U) is p -connected. Then there exists a homotopy $f: P \times I \rightarrow M$ rel P_0 such that $f(P \times \{1\}) \subseteq U$.*

Proof. The hypothesis that $\pi_k(M, U) = 0$ means that each map of pairs $(D^k, \partial D^k) \rightarrow (M, U)$ can be homotoped, relative to the boundary, to a map $D^k \rightarrow U$.

Assume inductively that the $(k - 1)$ -skeleton of P is already contained in U and consider the k -skeleton $P^{(k)}$ of P . Each simplex A in the k -skeleton can be homotoped into U rel ∂A , since $k \leq p$ and (M, U) is p -connected. In this way we can define an homotopy on $P_0 \cup P^{(k)}$ that is constant on P_0 and that takes $P_0 \cup P^{(k)}$ into U . Since the pair $(P, P_0 \cup P^{(k)})$ satisfies the homotopy extension property, we are able to extend this homotopy on the whole P , completing the inductive step. \square

The Engulfing Theorem improves the previous lemma in the much stronger result that the open set U can be enlarged to “engulf” the whole polyhedron P .

We will not start by proving the complete statement of the Engulfing Theorem, but we will first give some proofs of it when the codimension of P is big enough and when P is compact for the following reasons:

- the basic ideas of the final proof are already present in these simpler cases;
- the problems that one encounters when trying to generalise these simpler proofs to the general case give enough motivation to endure some technicalities of the final proof.

Step 1: P compact, $2(p + 1) - n < 0$.

Denote with P_0 the biggest subcomplex of P contained in U . It follows from the hypotheses and Lemma 14.25 that there exists a continuous homotopy $f: P \times I \rightarrow M$ relative to P_0 such that $f(P \times \{1\}) \subseteq U$. We can apply Theorem 14.20 to obtain a new map $g: P \times I \rightarrow M$ that is a PL map, that coincides with f on $P \times \{0\}$ and such that $g(P \times 1) \subseteq U$.

Moreover the singular set $S(g)$ has dimension at most $2(p + 1) - n < 0$ and therefore g is an embedding. Since $P \times I \searrow P \times 1$ and g is a PL embedding, we have that $g(P \times I) \searrow g(P \times 1)$ and therefore by Corollary 14.16 (or also Lemma 14.18) there exists an ambient isotopy of M with compact support mapping P inside U . If we call h^{-1} the isomorphism at the end of this isotopy, we have that $P \subseteq h(U)$.

Step 2: P compact, $p \leq n - 4$.

We try now to improve the hypothesis on the codimension. In this case it is not true a priori that g is an embedding, because the dimension of its singular set can be positive. This is a problem, because the collapse $P \times I \searrow P \times \{1\}$ does not induce a collapse on the image. We want to get rid of the singular set.

First good idea: We can suppose that by induction we are able to engulf subpolyhedra of dimension $p' < p$. If we are able to show that the dimension of $S(g)$ is strictly smaller than p we can engulf its image by induction. We have

$$\dim(S(g)) = 2p + 2 - n < p \iff p < n - 2$$

Therefore, if $p \leq n - 3$ we can engulf the image of the singular set by inductive hypothesis.

Problem: It is not true in general that $P \times I \searrow P \times \{1\} \cup S(g)$.

Second good idea: Using Lemma 14.19 we can find $S^+(g)$, such that $S(g) \subseteq S^+(g)$ and $P \times I \searrow P \times \{1\} \cup S^+(g)$. Since $\dim S^+(g) \leq \dim S(g) + 1$ we need

$$2p + 3 - n < p \iff p < n - 3.$$

Since by hypothesis we have $p \leq n - 4$ we can suppose that also the image of $S^+(g)$ is contained in U .

At this point, since the collapse $P \times I \searrow P \times \{1\} \cup S^+(g)$ takes place away from singular set, we can use Lemma 14.22 to mirror this collapse on the image. Since the image of $P \times \{1\} \cup S^+(g)$ has been engulfed from U , we can conclude as in Step 1.

As a result of the previous discussion, we have that the Engulfing Theorem holds for compact polyhedron P of codimension $\leq n - 4$. We will now present the proof of the more general result, that allows P to be non compact and of codimension $\leq n - 3$.

We assert that it is not difficult to drop the compactness hypothesis, due to the hypothesis of compactness of the set $P \cap (M \setminus U)$. What needs a more clever idea is to allow for codimension $n - 3$. The key observation is that, in order to engulf P we only need to engulf $g(P \times \{0\})$ and not the whole image of $P \times I$; if we pay attention to this and manage U to carefully select what portion of $g(P \times I)$ to engulf, we will be able to prove the case $p = n - 3$.

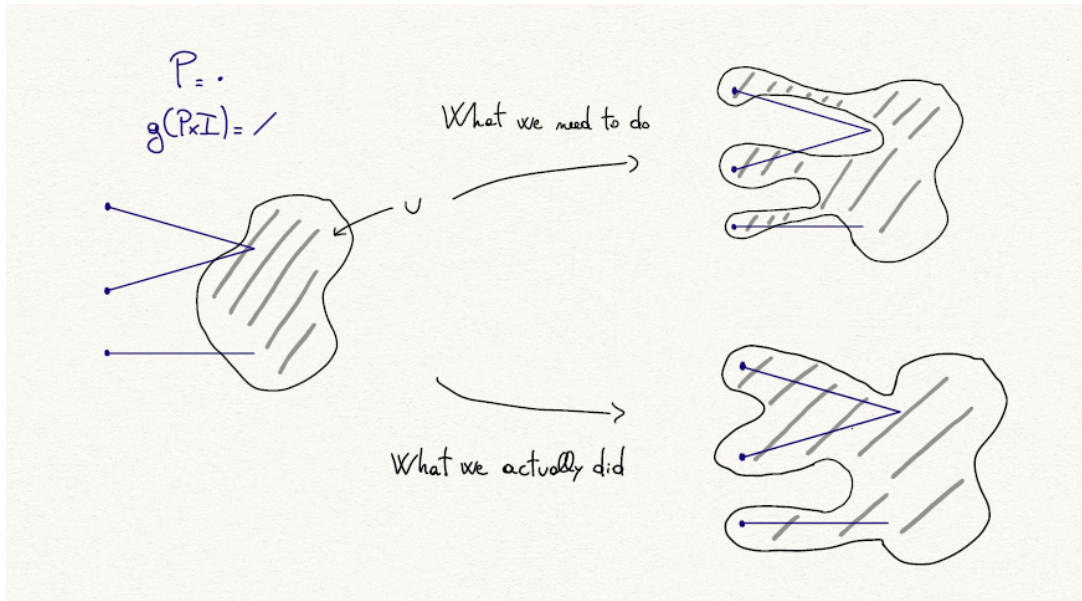

FIGURE 14.7

Proof of Theorem 14.24. It is clear that we can suppose that $P \setminus P_0$ has only one simplex Δ , by using an induction argument on the number of simplices in $P \setminus P_0$. We denote with q the dimension of Δ , and we notice that by hypothesis $q \leq p \leq n - 3$. The hypotheses of the theorem yield a continuous map $F: \Delta \times I \rightarrow M$ such that $F|_{\Delta \times \{0\}}$ is the inclusion of Δ in M and $F(\Delta \times \{1\}) \subseteq U$. Now we consider the polyhedron $K = \Delta \times I \cup_{\Delta \times \{0\}} P$ and we can glue the inclusion of P with the map F to obtain a map $f: K \rightarrow M$. We can apply Theorem 14.20 to obtain a map g that is PL and a triangulation T of K such that

- g is an embedding restricted to any simplex of T ;
- given simplices A and B , $A \cap g^{-1}(g(B)) = (A \cap B) \cup S(A, B)$ where $S(A, B)$ is a compact subpolyhedron of A of dimension $\leq \dim A + \dim B - n$.

Moreover, up to passing to a subdivision, we can also suppose that T simplicially collapses to $K_0 = P_0 \cup (\partial\Delta \times I) \cup (\Delta \times \{1\})$. This follows from the fact that $\Delta \times I$ collapses to $(\partial\Delta \times I) \cup (\Delta \times \{1\})$.

In other words we have a finite number of simplices A_1, \dots, A_s such that:

- $K = K_0 \cup A_1 \cup \dots \cup A_s$,
- each A_i has a vertex v_i and a face B_i such that $A_i = v_i * B_i$ and

$$(K_0 \cup A_1 \cup \dots \cup A_{i-1}) \cap A_i = v_i * \partial B_i.$$

We denote with K_i the union $(K_0 \cup A_1 \cup \dots \cup A_i)$ and with D_i its p -skeleton. Our aim is to engulf $g(D_i)$. Notice that $D_i = K_i$ except when the simplex Δ has dimension $q = p$, and that in any case $P \subseteq D_s$, the p -skeleton of K .

We can suppose by induction that the statement of the Engulfing Theorem holds for $q' < q$, i.e. that the statement of the theorem holds for subpolyhedra of M of dimension $q' < q$. Also suppose by induction that $g(D_{i-1})$ has already been engulfed. We now prove that it is possible to engulf $g(D_i)$.

Exactly as in Step 2 we have the problem that the collapse of $D_{i-1} \cup A_i$ to D_{i-1} does not induce a collapse of the images, since g is a priori not injective on $D_{i-1} \cup A_i$. But exactly as before we can consider the set

$$\Sigma_i = \cup \{S(A_i, B) \mid B \text{ is a simplex in } D_{i-1}\}.$$

The set Σ_i is the singular set of the map g restricted to $D_{i-1} \cup A_i$ and Σ_i is a compact subpolyhedron of A_i of dimension

$$\dim \Sigma_i \leq \dim A_i + p - n \leq q + 1 + (n - 3) - n \leq q - 2.$$

Since $\dim \Sigma_i \leq q - 2$, when we consider the set Σ_i^+ from Lemma 14.19 we have that $\dim \Sigma_i^+ \leq q - 1$ and so we can apply the inductive hypothesis and obtain a compactly supported isomorphism $h: M \rightarrow M$ such that U engulfs $g(D_i \cup \Sigma_i^+)$. Since now $A_i \searrow (v_i * \partial B_i) \cup \Sigma_i^+$ we can use Lemma 14.22 to mirror this collapse on the image and deduce that there exists an isomorphism $h': M \rightarrow M$ with compact support such that $h(U)$ contains $g(A_i \cup D_{i-1})$. The composition $h' \circ h$ gives the engulfing of $g(D_i)$ from U .

Since $P \subseteq D_s$, we have proved the Engulfing Theorem. \square

Remark 14.26. Notice that in the proof of the inductive step we actually managed to engulf the whole image of the simplex A_i , so it could seem that at the end the open set U engulfed the whole image of K . The important point is that when trying to engulf the image of the next simplex A_{i+1} we cannot impose that the open set keeps containing $g(A_i)$ during the isotopy, but only its p -skeleton.

So what happens is that at each step the open set U loses some pieces of what it has already engulfed. This is not a problem as long as none of these pieces belongs to the p -skeleton of the image of K and this is something we can control. The next figure is a schematic picture of what can happen.

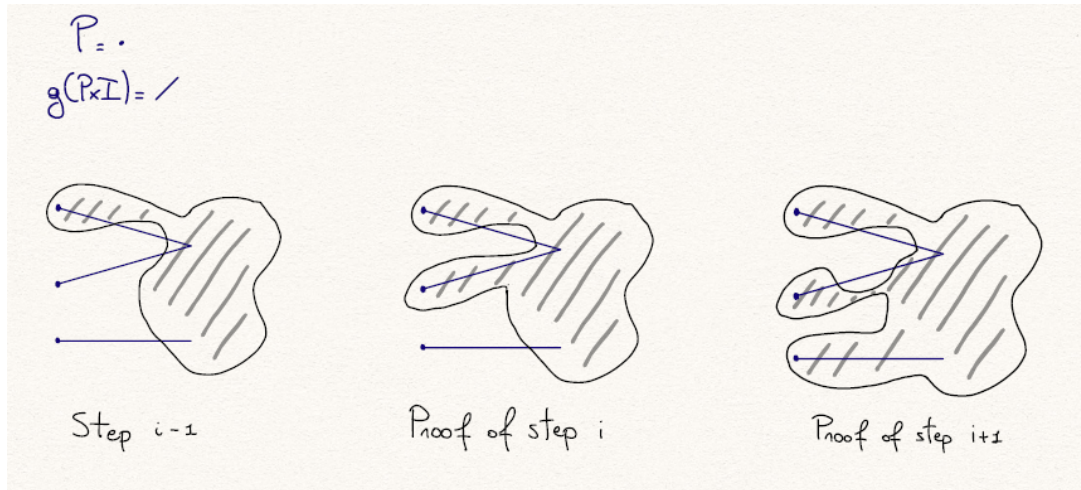

FIGURE 14.8

As a corollary of the Engulfing Theorem we have

COROLLARY 14.27. *Suppose that M^n is a contractible PL manifold and that $C \subseteq M$ is a compact subpolyhedron in M of dimension $\leq n - 3$. Then C is contained in an n -ball.*

Proof. Take U to be any n -ball in M . Since both M and U are contractible, as a consequence of the long exact sequence of homotopy groups of the pair we have that (M, U) is p -connected for all p . Since C is compact, the set $C \cap (M \setminus U)$ is compact. Moreover the dimension of C is $\leq n - 3$ by hypothesis and therefore we can apply the Engulfing Theorem to find an isomorphism $h: M \rightarrow M$ such that C is contained in the n -ball $h(U)$. \square

14.4. Uniqueness of PL structures on \mathbb{R}^n

In this last section we will use the Engulfing Theorem to prove

THEOREM 14.28 (Uniqueness of PL structure). *Let $n \geq 5$. Then there exists a unique PL structure on \mathbb{R}^n up to isomorphism.*

Remark 14.29. It is proved with other techniques that \mathbb{R}^n has a unique PL structure if $n \leq 3$ [Moi52a]. On the other hand, it can be showed that \mathbb{R}^4 has uncountably many different PL structures [Tau87].

We recall the following definition.

Definition 14.30. A topological space X is said to be *simply connected at infinity* if for any compact set $C \subseteq X$ there exists a compact D such that $C \subseteq D \subseteq X$ and $X \setminus D$ is simply connected.

THEOREM 14.31. *Let M^n be a connected and oriented manifold with possibly empty boundary. Then any two cooriented embeddings of n -balls in $\text{Int}(M)$ are ambiently isotopic.*

Theorem 14.28 will be a corollary of the following proposition.

PROPOSITION 14.32. *Suppose that M^n , $n \geq 5$, is a contractible manifold that is simply connected at infinity. Then any compact subset of M is contained in an n -ball.*

Proof of Theorem 14.28. Let M^n be contractible and simply connected at infinity. Then the existence of a countable compact exhaustion of M and Proposition 14.32 imply that M is the union of $\{F_i\}_{i \in \mathbb{N}}$, where each F_i is a n -ball, and $F_i \subseteq \text{Int} F_{i+1}$. We now prove that all the

manifolds obtained in this way are isomorphic, and since \mathbb{R}^n can be obtained in this way the theorem follows.

Suppose that we have $F_i \subseteq \text{Int } F_{i+1}$ and $G_i \subseteq \text{Int } G_{i+1}$ two pair of nested n -balls and fix any isomorphism $f_i: F_i \rightarrow G_i$. If we are able to show that there exists an isomorphism $f_{i+1}: F_{i+1} \rightarrow G_{i+1}$ that extends f_i we have finished, since we can iterate this process countably many times, starting with a fixed isomorphism $f_1: F_1 \rightarrow G_1$, to obtain an isomorphism $\bigcup_{i \in \mathbb{N}} \{F_i\} \rightarrow \bigcup_{i \in \mathbb{N}} \{G_i\}$.

Suppose that we have fixed f_i and consider any isomorphism $f'_{i+1}: F_{i+1} \rightarrow G_{i+1}$ with the property that its restriction to F_i is cooriented with f_i . Then by Theorem 14.31 we know that there exists an isomorphism $H: G_{i+1} \rightarrow G_{i+1}$ such that $(H \circ f'_{i+1})|_{F_i} = f_i$. Simply define $f_{i+1} = H \circ f'_{i+1}$. \square

Our aim now is to prove Proposition 14.32. We start with some simple lemmas.

LEMMA 14.33. *Suppose M^n is a manifold that is contractible and simply connected at infinity. Then for any compact set $C \subseteq M$ there exists a compact set D such that $C \subseteq D \subseteq M$ and $(M, M \setminus D)$ is 2-connected.*

Proof. Consider D such that $M \setminus D$ is simply connected. Consider the long exact sequence of homotopy groups of the pair

$$\dots \rightarrow \pi_2(M) \rightarrow \pi_2(M, M \setminus D) \rightarrow \pi_1(D) \rightarrow \pi_1(M) \rightarrow \pi_1(M, M \setminus D) \rightarrow \dots$$

Since M is contractible and $M \setminus D$ is simply connected, we deduce that $(M, M \setminus D)$ is 2-connected. \square

LEMMA 14.34. *Suppose M^n , $n \geq 5$, is a manifold that is contractible and simply connected at infinity. Let $T^{(2)}$ denote the 2-skeleton of a triangulation T of M and let $C \subseteq M$ be a compact subset. Then there exists an isomorphism $h: M \rightarrow M$ whose support is compact and contains C and such that $M \setminus C$ engulfs $T^{(2)}$, i.e. $T^{(2)} \subseteq h(M \setminus C)$.*

Proof. Consider a compact set D such that $C \subseteq D \subseteq M$ and $(M, M \setminus D)$ is 2-connected. Since $T^{(2)}$ is a 2-dimensional polyhedron, $n \geq 5$, and $T^{(2)} \cap D$ is compact, being D compact, we can apply the Engulfing Theorem and find a compactly supported isomorphism $h: M \rightarrow M$ such that $T^{(2)} \subseteq h(M \setminus D) \subseteq h(M \setminus C)$. If the support of h does not contain C we can simply consider its union with C , that is still compact. \square

Proof of Proposition 14.32. Consider $C \subseteq M$ a compact subset and consider $T^{(2)}$ the 2-skeleton of some triangulation of M . We know that, up to isomorphism of M , we can suppose that $C \cap T^{(2)} = \emptyset$. Define K as the polyhedron obtained by adding to $T^{(2)}$ all the closed simplices of T that are contained in $M \setminus C$. Consider $C(K)$, the complement of K . $C(K)$ is defined in the following way:

- consider the first barycentric subdivision of T and denote it by \tilde{T} ;
- consider the unique simplicial map $f_K: \tilde{T} \rightarrow [0, 1]$ defined by mapping the vertices of \tilde{T} that are in K to 0 and the other vertices in 1;
- define $C(K) = f_K^{-1}(1)$.

CLAIM. *The subpolyhedron $C(K)$ is compact and has dimension $\leq n - 3$.*

We postpone the proof of the claim to the end of the proof.

Since $C(K)$ has dimension $\leq n - 3$ and is compact, by virtue of Corollary 14.27 we can suppose that $C(K)$ is contained in an n -ball A .

To conclude the proof of the proposition it is sufficient to observe that since $C(K)$ is compact there exists $t_1 \in (0, 1)$ such that $C(K) \subseteq f_K^{-1}([t_1, 1]) \subseteq A$. Moreover since C is compact and contained in $M \setminus K$ there exists $t_2 \in (0, 1)$ such that $C \subseteq f_K^{-1}([t_2, 1])$.

Since both $f_K^{-1}([t_1, 1])$ and $f_K^{-1}([t_2, 1])$ are regular neighbourhoods of $C(K)$ in M , by virtue of Theorem 14.14, it is possible to find an isomorphism $h: M \rightarrow M$ such that $C \subseteq h(A)$, which is an n -ball. \square

Proof of the claim. It is easy to prove that $C(K)$ contains only a finite number of vertices. In fact its vertices are contained in the simplices of T that intersect the compact C , and therefore are contained in a finite number of simplices. This implies the compactness of T .

The bound on the dimension of $C(K)$ follows from the fact that any k -simplex of \tilde{T} intersects a $(n - k)$ -simplex of T . In fact the operation of first barycentric subdivision can be described in the following way:

- **Step 0:** Do nothing. Rename the 0-skeleton of T by $T_0^{(0)}$
- **Step 1:** Add to each edge of T its barycenter and subdivide $T^{(1)}$ by taking the cones with vertices these barycenters and base $T_0^{(0)}$. In this way we obtain a new triangulation of the 1-skeleton of T . Denote the new 0-skeleton with $T_1^{(0)}$ and the new 1-skeleton with $T_1^{(1)}$.
- **Step 2:** Add the barycenters of the 2-simplices of T and take the cones with vertices these barycenters and base $T_1^{(1)}$. In this way we obtain a new triangulation of the 2-skeleton of T . Denote the new 0-skeleton, 1-skeleton and 2-skeleton with $T_2^{(0)}$, $T_2^{(1)}$ and $T_2^{(2)}$.
- Iterate this process up to the n -skeleton. By construction $T_n^{(n)}$ is the barycentric subdivision \tilde{T} .

Using this description it is easy to prove that:

- each simplex in $T_1^{(1)}$ contains a vertex of $T_0^{(0)} = T^{(0)}$;
- each simplex of $T_2^{(2)}$ contains an edge of $T_1^{(1)}$;
- each 3-simplex of $T_3^{(3)}$ contains a 2-simplex of $T_2^{(2)}$. Analogously each 2-simplex of $T_3^{(2)}$ contains a 1-simplex of $T_2^{(1)}$ and each 1-simplex of $T_3^{(1)}$ contains a vertex of $T_2^{(0)}$;
- by induction, each k -simplex of $T_m^{(k)}$, with $k \leq m$, contains a $(k - h)$ -simplex of $T_{m-h}^{(k-h)}$, with $h \leq k$.

The schematic picture of Figure 14.9 should help to visualise this “cascade” situation.

In particular, each simplex of dimension $\geq n - 2$ in $\tilde{T} = T_n^{(n)}$ must contain a simplex in $T_2^{(2)}$. Since $|T_2^{(2)}| = |T^{(2)}|$ and K contains the 2-skeleton of T , it follows that any such simplex must intersect K . This implies that any simplex of $C(K)$ has dimension at most $n - 3$. \square

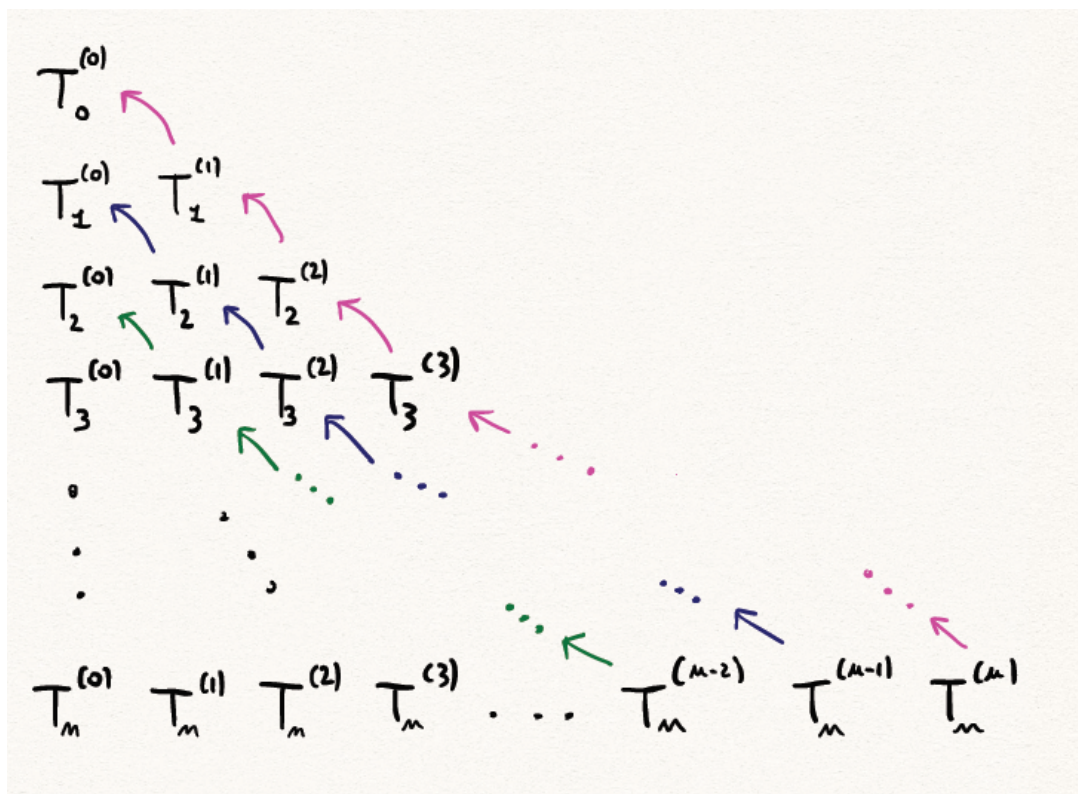

FIGURE 14.9

Remark 14.35. Notice that even if to prove the uniqueness of PL structures on \mathbb{R}^n when $n \geq 5$ it was crucial to engulf compact sets, we actually needed the full strength of Stallings' version of the Engulfing Theorem, since in Lemma 14.34 we needed to engulf $T^{(2)}$ that is a non compact polyhedron.

Remark 14.36. Consider an exotic \mathbb{R}^4 , i.e. a PL structure on \mathbb{R}^4 that is non isomorphic to the standard one. In such a PL manifold there must exist a compact set C that is not contained in any PL 4-ball, otherwise from the proof of Theorem 14.28 we would find an isomorphism with the standard \mathbb{R}^4 .

As a further corollary of what we have proven so far we have a proof of the so called *weak Poincaré conjecture* in dimension ≥ 5 .

COROLLARY 14.37 (High dimensional weak Poincaré conjecture). *Suppose that M^n is a closed PL manifold homotopy equivalent to S^n , with $n \geq 5$. Then $M \cong_{Top} S^n$.*

Proof. Consider a point $p \in M$. We can use Proposition 14.38 (which is proved later) to deduce that $M \setminus \{p\}$ is contractible and simply connected at infinity. By virtue of Theorem 14.28 $M \setminus \{p\} \cong_{PL} \mathbb{R}^n$. Therefore M is the one-point compactification of \mathbb{R}^n , and hence a topological sphere. \square

PROPOSITION 14.38. *Let $n \geq 3$. Suppose that M^n is a closed topological manifold homotopy equivalent to S^n and consider a point $p \in M$. Then $M \setminus \{p\}$ is simply connected at infinity and contractible.*

Proof. We divide the proof in two parts.

Part 1: By definition there exist continuous $f: M \rightarrow S^n$ and $g: S^n \rightarrow M$ such that $gf \sim Id_M$ and $fg \sim Id_{S^n}$. Consider the north pole $N = (0, \dots, 0, 1) \in S^n$ and without loss of generality we

can suppose that $p = g(N)$. Since any rotation of S^n is isotopic to the identity, we can compose f with a rotation of S^n and suppose that $g(p) = N$. We now prove that it is possible to find $g': S^n \rightarrow M$ and homotopies $g'f \sim \text{Id}_M$ and $fg' \sim \text{Id}_{S^n}$ that fix respectively p and N .

First consider an arbitrary homotopy $\Phi: M \times I \rightarrow M$ between gf and Id_M . The image of $\{p\} \times I$ via this homotopy is a continuous loop $\gamma: I \rightarrow M$. We want to compose this homotopy with an isotopy of M that at each time brings back the point $\gamma(t)$ to p . To do this we consider an ambient isotopy of M extending the curve γ , i.e. an isotopy $\chi: M \times I \rightarrow M$ such that $\chi_t(p) = \gamma(t)$ and $\chi_1 = \text{Id}_M$. The homotopy $\chi^{-1}\Phi: M \times I \rightarrow M$ defined by

$$(x, t) \mapsto \chi_t^{-1}(\Phi_t(x))$$

satisfies:

- $(\chi^{-1}\Phi)_t(p) = \chi_t^{-1}(\gamma(t)) = p$.
- $(\chi^{-1}\Phi)_1(x) = \chi_1^{-1}(\Phi_1(x)) = x$ for all $x \in M$.
- $(\chi^{-1}\Phi)_0(x) = \chi_0^{-1}(\Phi_0(x)) = \chi_0^{-1}(g(f(x)))$.

Since $\chi_0^{-1}(p) = p$ we can replace g with $g' = \chi_0^{-1}g$. Now $g': S^n \rightarrow M$ is such that $g'f \sim \text{Id}_M$ fixing p .

We now want to proceed analogously with f .

First of all, notice that since χ_0^{-1} is isotopic to the identity of M , it is still true that $fg' \sim \text{Id}_{S^n}$. Consider an arbitrary homotopy $\Psi: S^n \times I \rightarrow S^n$ between fg' and Id_{S^n} . Also in this case the image of $\{N\} \times I$ is a continuous loop δ in S^n . In the same way as before, we want to find an isotopy of S^n that at each time brings back the point $\delta(t)$ to N , but we can do this in a smarter way. In fact there is a fibration $\pi: \text{SO}(n+1) \rightarrow S^n$ defined by

$$A \mapsto A(N).$$

Since the fibrations have the path lifting property, we can lift the path $\delta: I \rightarrow S^n$ to a path $\tilde{\delta}: I \rightarrow \text{SO}(n+1)$ such that $\tilde{\delta}(1) = \text{Id}$.

We can now define a homotopy $\tilde{\delta}^{-1}\Psi: S^n \times I \rightarrow S^n$ by

$$(y, t) \mapsto \tilde{\delta}_t^{-1}(\Psi_t(y)).$$

This homotopy satisfies:

- $(\tilde{\delta}^{-1}\Psi)_t(N) = \tilde{\delta}_t^{-1}(\delta(t)) = N$
- $(\tilde{\delta}^{-1}\Psi)_1(y) = \tilde{\delta}_1^{-1}(\Psi_1(y)) = y$ for all $y \in S^n$.
- $(\tilde{\delta}^{-1}\Psi)_0(y) = \tilde{\delta}_0^{-1}(\Psi_0(y)) = \tilde{\delta}_0^{-1}(f(g'(x)))$ for all $y \in S^n$.

So we have proven that there is a homotopy between Id_{S^n} and $\tilde{\delta}_0^{-1}fg'$ keeping N fixed. Since $\tilde{\delta}_0$ is a rotation of S^n that fixes N (it is a lifting via the fibration π of $\delta(0) = 0$), of course we deduce that there is also such a homotopy between Id_{S^n} and fg' , that is what we wanted to prove.

Part 2: It follows from **Part 1** that $M \setminus \{p\}$ is homotopy equivalent to \mathbb{R}^n . This of course implies that $M \setminus \{p\}$ is contractible.

Notice that simply connectedness at infinity is not a homotopical invariant, since for example \mathbb{R}^2 is not simply connected at infinity but is homotopy equivalent to \mathbb{R}^3 , which is. However our situation is way simpler. In fact consider a compact $C \subseteq M \setminus \{p\}$ and consider a small open n -ball in M containing p and not intersecting C . The complement of this ball in $M \setminus \{p\}$ is a compact D that contains C . By construction the complement of D is homeomorphic to a punctured n -ball, which is simply connected if $n \geq 3$. \square

Part VI

The torus trick and the annulus theorem

Homeomorphisms of \mathbb{R}^n and the torus trick

Anthony Conway, Danica Kosanović, and Arunima Ray

The torus trick was developed by Kirby [Kir69] to prove the annulus theorem in dimension ≥ 5 . Since that proof uses some nontrivial input from PL topology, we prefer to introduce it using another application, namely to show the local contractibility of $\text{Homeo}(\mathbb{R}^n)$, which is one of the main results of this section (see Corollary 15.11) and was first proved by Černavskii [Č73]. This use of the torus trick requires much less input from outside the topological category.

The torus trick turned out to be a very useful method of proof, in many different contexts. Its key applications include topological transversality, isotopy extension, existence of topological handle decompositions, topological invariance of simple homotopy type, and smoothing theory – these are all major advances in the understanding of topological manifolds. We will discuss some of these applications later. The torus trick can also be applied in low dimensional manifolds of dimension 2 and 3 to show that they admit unique smooth structures [Ham76a, Hat13a].

15.1. Homeomorphisms bounded distance from the identity and Alexander isotopies

We begin our study of $\text{Homeo}(\mathbb{R}^n)$ with an elementary but extremely useful observation.

Definition 15.1. A homeomorphism $h \in \text{Homeo}(\mathbb{R}^n)$ is *bounded distance from Id* if there exists $K > 0$ such that $|h(x) - x| < K$ for all $x \in \mathbb{R}^n$.

In the literature such homeomorphisms are often called ‘bounded’. We prefer the longer descriptor to avoid a non-traditional and potentially confusing use of that term.

PROPOSITION 15.2. *If $h \in \text{Homeo}(\mathbb{R}^n)$ is bounded distance from Id, then h is isotopic to $\text{Id}_{\mathbb{R}^n}$.*

Proof. Define the map

$$H(x, t) := \begin{cases} t \cdot h\left(\frac{x}{t}\right), & t \neq 0, \\ x, & t = 0. \end{cases}$$

Note that $H(-, 0) = \text{Id}_{\mathbb{R}^n}$, $H(-, 1) = h$ and each $H(-, t)$ is a homeomorphism of \mathbb{R}^n . Moreover, H is clearly continuous on $\mathbb{R}^n \times (0, 1]$. For $x_0 \in \mathbb{R}^n$, we check continuity at $(x_0, 0)$ directly next.

Given $\varepsilon > 0$ we choose $\delta = \min\{\frac{\varepsilon}{2}, \frac{\varepsilon}{2K}\}$. Then for any (x, t) with $|(x, t) - (x_0, 0)| < \delta$, we in particular have $|x - x_0| < \delta$ and $t < \delta$, so

$$|H(x, t) - H(x_0, 0)| = \begin{cases} |t \cdot h\left(\frac{x}{t}\right) - x_0| \leq |t \cdot h\left(\frac{x}{t}\right) - x| + |x - x_0| < tK + \delta < \delta K + \delta < \varepsilon & t \neq 0 \\ |x - x_0| < \delta < \varepsilon & t = 0 \end{cases}$$

where for the second inequality in the first case we used the fact that h is bounded distance from Id, namely

$$|t \cdot h\left(\frac{x}{t}\right) - x| = t \left| h\left(\frac{x}{t}\right) - \frac{x}{t} \right| < tK. \quad \square$$

We next derive a few consequences, all of which go under the name “Alexander trick” or “Alexander isotopy”. The first of the cases below does not use Proposition 15.2 and has a somewhat easier proof.

PROPOSITION 15.3 (Alexander isotopies). *Let n be a positive integer.*

- (0) *Every $f \in \text{Homeo}(S^{n-1})$ extends to $F \in \text{Homeo}(D^n)$.*
- (i) *For any $h \in \text{Homeo}(D^n)$, if $h|_{\partial D^n} = \text{Id}$ then h is isotopic to Id_{D^n} .*
- (ii) *For any $f, g \in \text{Homeo}(D^n)$ if $f|_{\partial D^n} = g|_{\partial D^n}$ then f and g are isotopic.*
- (iii) *For any $h \in \text{Homeo}(\mathbb{R}^n)$ if $h|_{D^n} = \text{Id}$ then h is isotopic to $\text{Id}_{\mathbb{R}^n}$.*
- (iv) *For any $f, g \in \text{Homeo}(\mathbb{R}^n)$, if $f|_{D^n} = g|_{D^n}$ then f and g are isotopic.*
- (v) *For any $f, g \in \text{Homeo}(\mathbb{R}^n)$, if $f|_U = g|_U$ for an open $U \subseteq \mathbb{R}^n$ then f and g are isotopic.*

Proof. For (15.3.0), we use that the disc D^n is homeomorphic to the cone on the sphere S^{n-1} , so we can define the extension F the cone of the map f , by setting $F(t, z) = t \cdot f(z)$ for $(t, z) \in D^n$ corresponding to $z \in S^{n-1}$.

For (15.3.i) we extend h by the identity map to a homeomorphism of \mathbb{R}^n , which is clearly bounded distance from Id . By Proposition 15.2 this extension is isotopic to $\text{Id}_{\mathbb{R}^n}$ via a 1-parameter family of maps $H(-, t)$, each of which restricts to the identity on the complement of the open unit disc, so their restrictions give the desired isotopy from h to Id_{D^n} . This isotopy rescales a given point “outwards”, applies h and then pulls it back in. For each x there is a small enough t so that $\frac{x}{t}$ is outside the unit disc, where we apply the identity. In other words, the region where the identity is applied expands inwards as t decreases.

Now (15.3.ii) follows directly from (15.3.i): we apply it to $h := g^{-1}f$ to get an isotopy H , and then observe that gH is an isotopy from f to g .

To prove (15.3.iii) we define an isotopy $H: \mathbb{R}^n \times [0, 1] \rightarrow \mathbb{R}^n$ from $\text{Id}_{\mathbb{R}^n}$ to h given by

$$H(x, t) := \begin{cases} \frac{1}{t}h(tx) & t \neq 0 \\ x & t = 0. \end{cases}$$

(Here the identity expands “outwards” as t decreases.) We may check continuity as in the proof of Proposition 15.2. Namely, continuity away from $t = 0$ is again immediate, and given $x_0 \in \mathbb{R}^n$ and $\varepsilon > 0$, we choose $\delta = \min\{\frac{1}{1+|x_0|}, 1, \varepsilon\}$. Then if $|(x, t) - (x_0, 0)| < \delta$, we have $t < \delta$ and $|x| - |x_0| \leq |x - x_0| < \delta \leq 1$. In particular, $|x| < 1 + |x_0|$ and $|tx| = t|x| < \delta(1 + |x_0|) \leq \frac{1+|x_0|}{1+|x_0|} = 1$, so tx is contained in D^n . Therefore, $h(tx) = tx$ by hypothesis, and we have

$$|H(x, t) - H(x_0, 0)| = \begin{cases} \left| \frac{1}{t}h(tx) - x_0 \right| = \left| \frac{1}{t}(tx) - x_0 \right| = |x - x_0| < \delta < \varepsilon, & t \neq 0, \\ |x - x_0| < \delta < \varepsilon, & t = 0. \end{cases}$$

For (15.3.iv), apply (15.3.iii) to $g^{-1}f$.

For (15.3.v) choose a disc within U and rescale it to a unit disc D^n , then apply (15.3.iv). \square

The local contractibility of $\text{Homeo}(\mathbb{R}^n)$ will be a consequence of the following theorem.

THEOREM 15.4 (Černavskiĭ [Č73], Kirby [Kir69]). *For any $n \geq 0$ there exists $\varepsilon > 0$ such that every homeomorphism $h: \mathbb{R}^n \rightarrow \mathbb{R}^n$ satisfying $|h(x) - x| < \varepsilon$ for all $x \in D^n$ is isotopic to $\text{Id}_{\mathbb{R}^n}$.*

In other words, if $h \in \text{Homeo}(\mathbb{R}^n)$ and $\text{Id}_{\mathbb{R}^n}$ are close on the unit disc D^n , then they are isotopic. Contrast this with Proposition 15.2, where we require that they are close everywhere to reach the same conclusion. Observe also that ε does not depend on h , but only on n .

15.2. Torus trick – the proof of the Černavskii-Kirby theorem

The proof of Theorem 15.4 given by Černavskii [Č73] is explicit and similar in spirit to the proof of Kister’s theorem (Theorem 8.10). We will instead present Kirby’s proof [Kir69] using the torus trick. Given $h \in \text{Homeo}(\mathbb{R}^n)$ the strategy is to construct a homeomorphism $\tilde{h} \in \text{Homeo}(\mathbb{R}^n)$ with the following key properties:

- (1) \tilde{h} and h agree on an open set, and are therefore isotopic (Proposition 15.3.v);
- (2) \tilde{h} is bounded distance from Id, and therefore isotopic to the identity (Proposition 15.2).

How can we build the map \tilde{h} ? The next lemma shows that a homeomorphism of the n -torus

$$T^n := S^1 \times \dots \times S^1,$$

that is homotopic to the identity, induces a homeomorphism of \mathbb{R}^n which is bounded distance from Id. This will be a key step in the proof and indicates why the n -torus is such a key player.

LEMMA 15.5. *Given $f \in \text{Homeo}(T^n)$ there exists $\tilde{f} \in \text{Homeo}(\mathbb{R}^n)$ so that*

$$\begin{array}{ccc} \mathbb{R}^n & \xrightarrow{\tilde{f}} & \mathbb{R}^n \\ \downarrow e & \cong & \downarrow e \\ T^n & \xrightarrow{f} & T^n \end{array}$$

commutes, where $e: \mathbb{R}^n \rightarrow T^n$ is the universal covering map. Moreover, if f is homotopic to Id_{T^n} , then \tilde{f} is bounded distance from $\text{Id}_{\mathbb{R}^n}$.

Proof. Fix $x_0 \in T^n$ and $y_0 \in e^{-1}(x_0)$. There exists a lift \tilde{f} of f since $\{0\} = (fe)_*(\pi_1(\mathbb{R}^n)) \leq e_*(\pi_1(\mathbb{R}^n)) = \{0\}$. Similarly, there exists a \tilde{g} lifting g for $g := f^{-1}$ so that $\tilde{g}\tilde{f}(y_0) = y_0$, and the diagram below commutes.

$$\begin{array}{ccccc} & & \text{Id}_{\mathbb{R}^n} & & \\ & \nearrow & \text{---} & \searrow & \\ (\mathbb{R}^n, y_0) & \xrightarrow{\tilde{f}} & (\mathbb{R}^n, \tilde{f}(y_0)) & \xrightarrow{\tilde{g}} & (\mathbb{R}^n, \tilde{g}\tilde{f}(y_0) = y_0) \\ \downarrow e & & \downarrow e & & \downarrow e \\ (T^n, x_0) & \xrightarrow{f} & (T^n, f(x_0)) & \xrightarrow{g} & (T^n, x_0) \\ & \searrow & \text{---} & \swarrow & \\ & & \text{Id}_{T^n} & & \end{array}$$

Note that both $\tilde{g} \circ \tilde{f}$ and $\text{Id}: \mathbb{R}^n \rightarrow \mathbb{R}^n$ are lifts of $g \circ f \circ e = \text{Id} \circ e = e$, and they agree on y_0 so by the uniqueness of lifting, we have that $\tilde{g} \circ \tilde{f} = \text{Id}$. The same argument with the rôles of f and g switched shows that $\tilde{f} \circ \tilde{g} = \text{Id}$, so \tilde{f} is the desired homeomorphism.

To prove the last statement, we use the following claim.

CLAIM. *If f is homotopic to Id_{T^n} , then \tilde{f} commutes with the deck transformations.*

Recall that the deck transformations of the cover $e: \mathbb{R}^n \rightarrow T^n$ are translations $\tau_a: \mathbb{R}^n \rightarrow \mathbb{R}^n$, given by $x \mapsto x + a$ for $a \in \mathbb{Z}^n$.

Proof of the claim. Fix some $a \in \mathbb{Z}^n$. We will prove that $\tilde{f} \circ \tau_a = \tau_a \circ \tilde{f}$. Observe that we have $fe = e\tilde{f}$ since \tilde{f} is a lift of f . For any $m \in \mathbb{Z}^n$, the deck transformation τ_m is by definition a lift of e so we have $e = e\tau_m$.

By assumption, there is a homotopy $F: T^n \times [0, 1] \rightarrow T^n$ from $F_0 = f$ to $F_1 = \text{Id}_{T^n}$, and we consider the map

$$F \circ (e \times \text{Id}): \mathbb{R}^n \times [0, 1] \xrightarrow{e \times \text{Id}} T^n \times [0, 1] \xrightarrow{F} T^n$$

where

$$F \circ (e \times \text{Id})|_{\mathbb{R}^n \times 0} = f \circ e = e \circ \tilde{f}$$

and

$$F \circ (e \times \text{Id})|_{\mathbb{R}^n \times 1} = e.$$

The map F is in particular a homotopy, so by the homotopy lifting property we can find $\tilde{F}: \mathbb{R}^n \times [0, 1] \rightarrow \mathbb{R}^n$ with

- $\tilde{F}_0 = \tilde{f}$, namely a lift of $F \circ (e \times \text{Id})|_{\mathbb{R}^n \times 0}$;
- $e\tilde{F} = F \circ (e \times \text{Id})$; and
- \tilde{F}_1 a lift of $F \circ (e \times \text{Id})|_{\mathbb{R}^n \times 1} = e$.

Since \tilde{F}_1 is a lift of e , there exists $c \in \mathbb{Z}^n$ such that $\tilde{F}_1 = \tau_c$.

Define $G := \tau_{-a} \circ \tilde{F} \circ (\tau_a \times \text{Id}): \mathbb{R}^n \times [0, 1] \rightarrow \mathbb{R}^n$ and note that for $t \in [0, 1]$ we have

$$\begin{aligned} e \circ G(x, t) &= e \circ \tau_{-a} \circ \tilde{F}(\tau_a(x), t) && \text{by definition of } G, \\ &= e \circ \tilde{F}(\tau_a(x), t) && \text{since } e = e \circ \tau_m \text{ for any } m \in \mathbb{Z}^n, \\ &= F(e \circ \tau_a(x), t) && \text{by definition of } \tilde{F}, \\ &= F(e(x), t) && \text{since } e = e \circ \tau_m \text{ for any } m \in \mathbb{Z}^n. \end{aligned}$$

Therefore, both G and \tilde{F} are lifts of $F \circ (e \times \text{Id})$ ending in $G_1 = \tilde{F}_1 = \tau_c$. By the uniqueness of lifting $G := \tau_{-a}\tilde{F}(\tau_a \times \text{Id}) = \tilde{F}$. In particular, $\tau_{-a}\tilde{f}\tau_a(x) = \tau_{-a}\tilde{F}(\tau_a(x), 0) = \tilde{F}(x, 0) = \tilde{f}(x)$, finishing the proof of the claim. \square

Let us now complete the proof of the lemma. Given $x \in \mathbb{R}^n$, we can write $x = x_0 + a = \tau_a(x_0)$, for some $x_0 \in I^n$ the unit cube and $a \in \mathbb{Z}^n$. Then

$$|\tilde{f}(x) - x| = |\tilde{f}(\tau_a(x_0)) - \tau_a(x_0)| = |\tau_a(\tilde{f}(x_0)) - \tau_a(x_0)| = |\tilde{f}(x_0) - x_0|$$

Therefore, \tilde{f} is indeed bounded distance from $\text{Id}_{\mathbb{R}^n}$ since

$$\sup_{x \in \mathbb{R}^n} |\tilde{f}(x) - x| = \sup_{x_0 \in I^n} |\tilde{f}(x_0) - x_0| < \infty. \quad \square$$

Returning to Theorem 15.4, we would like to leverage the above fact about homeomorphisms of tori, and the induced maps on \mathbb{R}^n . To do so, we need to first find a torus – and for this we will use smooth manifold topology, namely Smale-Hirsch theory. Recall the notions of smooth and topological immersions from Section 7.3.

COROLLARY 15.6 (of Theorem 7.14). *For all n there is a smooth immersion $\alpha: T^n \setminus \{pt\} \hookrightarrow \mathbb{R}^n$.*

Proof. The circle S^1 is parallelisable, and the product of parallelisable manifolds is parallelisable. An open subset of a parallelisable manifold is parallelisable, so Theorem 7.14 gives the result. \square

Let us point out that one need not rely on this machinery – there are explicit constructions of immersed punctured n -tori in \mathbb{R}^n , for example by Ferry [Fer74a], Milnor [KS77b, p. 43], and Barden [Rus73b, p. 290].

As a final ingredient in the upcoming proof of Theorem 15.4 we will need the following application of the Schoenflies theorem.

PROPOSITION 15.7. *Let Σ be a bicollared S^{n-1} in T^n for $n \geq 3$. Then Σ bounds a ball in T^n .*

Proof. First we prove that Σ is separating. This can be seen using the following portion of the Mayer-Vietoris sequence for $T^n = T^n \setminus \Sigma \cup \nu\Sigma$, where $\nu\Sigma$ is the image of the bicollar of Σ .

$$H_1(T^n) \xrightarrow{0} H_0(\Sigma \sqcup \Sigma) \longrightarrow H_0(T^n \setminus \Sigma) \oplus H_0(\Sigma) \longrightarrow H_0(T^n) \longrightarrow 0$$

where the first map is trivial since Σ is null-homologous in T^n for $n \geq 3$ (recall that T^n is an Eilenberg-MacLane space).

Let A and B denote the closures of the two components of $T^n \setminus \Sigma$. Then

$$\mathbb{Z}^n \cong \pi_1(T^n) \cong \pi_1(A) * \pi_1(B).$$

Since an abelian group cannot be represented as a nontrivial free product, one of the two pieces, say A , has trivial fundamental group. Then A lifts to the universal cover \mathbb{R}^n . In other words, the restriction of e to each component of the preimage of A is a homeomorphism. On the other hand, the boundary of each such component is a bicollared sphere in \mathbb{R}^n and by the Schoenflies theorem each component is a ball. Therefore A is a ball, completing the proof. \square

Remark 15.8. An alternative proof of this would be to notice that if Σ were non-separating, there would be an arc connecting one side of Σ to the other. Taking a tubular neighbourhood of this arc along with the bicollar of Σ we see that T^n is represented as a connected sum $M \# S^1 \times S^{n-1}$, indicating that $\pi_1(T^n) \cong \pi_1(M) * \mathbb{Z}$ for some closed n -manifold M . Since $n \geq 3$, and an abelian group cannot be represented as a nontrivial free product, we have a contradiction.

We are now ready to see our first application of the torus trick. We begin with a sketch, and encourage the reader to consult Fig. 15.2, which summarises all the steps.

Sketch of the proof of Theorem 15.4. We are given a homeomorphism $h: \mathbb{R}^n \rightarrow \mathbb{R}^n$ which is ε -close to $\text{Id}_{\mathbb{R}^n}$ on the unit disc, for some ε we will need to choose with care.

We will first use Corollary 15.6 to define an immersion $\alpha: T^n \setminus 2\mathring{D}^n \subseteq T^n \setminus \mathring{D}^n \hookrightarrow \mathbb{R}^n$, where $D^n \subseteq 2D^n \subseteq T^n$ are some carefully chosen discs. Next we will define another embedding $\hat{h}: T^n \setminus 2\mathring{D}^n \hookrightarrow T^n \setminus \mathring{D}^n$ such that the lower square of the following diagram commutes.

$$(15.1) \quad \begin{array}{ccc} \mathbb{R}^n & \xleftarrow{\tilde{h}} & \mathbb{R}^n \\ e \downarrow & & \downarrow e \\ T^n & \xleftarrow[\cong]{\bar{h}} & T^n \\ \uparrow & & \uparrow \\ T^n \setminus 2\mathring{D}^n & \xleftarrow[\text{emb.}]{\hat{h}} & T^n \setminus \mathring{D}^n \\ \downarrow \alpha & & \downarrow \alpha \\ \mathbb{R}^n & \xleftarrow[\cong]{h} & \mathbb{R}^n \end{array}$$

We will then use the Schoenflies theorem on the torus (Proposition 15.7) to lift \hat{h} to a homeomorphism $\bar{h}: T^n \rightarrow T^n$. Let us warn the reader that the middle square in the diagram does not quite commute – see the full proof for details. In order to have that \tilde{h} is isotopic to h , we will ensure in each of these steps that \bar{h} and h agree on an open set, and then use Proposition (15.3.v).

The final step consists of showing that \bar{h} is isotopic to $\text{Id}_{\mathbb{R}^n}$. As before, the choice of ε will be important here. Since \bar{h} is homotopic to the identity, the induced homeomorphism $\tilde{h}: \mathbb{R}^n \rightarrow \mathbb{R}^n$ is bounded distance from Id by Lemma 15.5, and is consequently isotopic to the identity (Proposition 15.2). Therefore, h is also isotopic to the identity, as desired. \square

With the sketch out of the way, here are the details in the proof of Theorem 15.4.

Proof of Theorem 15.4. Let us identify S^1 with $[0, 1] / 0 \sim 1$, so that $[0, \frac{1}{2}]$ is viewed as a subset of S^1 , and we have the closed ball

$$B := [0, \frac{1}{2}]^n \subseteq T^n \setminus \{\text{pt}\}$$

for a suitably chosen point $\text{pt} \in T^n$. Moreover, we choose closed concentric balls $A \subsetneq 2A \subsetneq 3A$ centred at $\text{pt} \in T^n$ and disjoint from B . Abusing notation we also write $B := [0, \frac{1}{2}]^n \subseteq \mathbb{R}^n$. The proof consists of building the maps in the following diagram.

$$(15.2) \quad \begin{array}{ccc} \mathbb{R}^n & \xrightarrow{\tilde{h}} & \mathbb{R}^n \\ \downarrow e & & \downarrow e \\ T^n & \xrightarrow[\cong]{\bar{h}} & T^n \\ \uparrow & & \uparrow \\ T^n \setminus 3\mathring{A} & \xrightarrow{\hat{h}|} & \hat{h}(T^n \setminus 3\mathring{A}) \\ \downarrow & & \downarrow \\ T^n \setminus 2\mathring{A} & \xrightarrow{\hat{h}} & T^n \setminus \mathring{A} \\ \downarrow \alpha & & \downarrow \alpha \\ \mathbb{R}^n & \xrightarrow[\cong]{h} & \mathbb{R}^n \end{array}$$

Our original homeomorphism h appears in the bottom row, and we start building the diagram from there upwards. We present the proof in a collection of steps and lemmas, so that the many details do not obscure the bigger picture and the structure of the proof is clear.

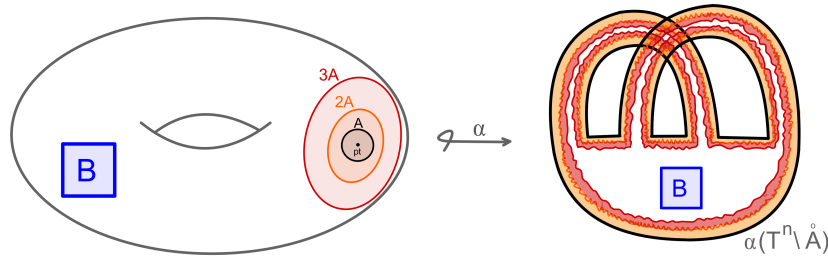

FIGURE 15.1. The key players in the proof of Theorem 15.4.

STEP 5. Construct an immersion $\alpha: T^n \setminus \{\text{pt}\} \looparrowright \mathbb{R}^n$ such that $\alpha(T^n \setminus 2\mathring{A}) \subseteq D^n$ and $\alpha|_B = \text{Id}$.

We will obtain α by modifying an immersion $\beta: T^n \setminus \{\text{pt}\} \looparrowright \mathbb{R}^n$ from Corollary 15.6. We begin with a smooth immersion, but the smoothness will not be important for the proof. Recall that an immersion is by definition a local embedding, and that β is an open map by invariance of domain. Therefore, we can find a closed ball $B' \subseteq B$ such that $\beta|_{B'}$ is a homeomorphism and $\beta(\partial B')$ is a bicollared $(n - 1)$ -sphere in \mathbb{R}^n .

We then choose homeomorphisms $j: T^n \setminus \{\text{pt}\} \rightarrow T^n \setminus \{\text{pt}\}$ and $k: \mathbb{R}^n \rightarrow \mathbb{R}^n$ such that j takes B' to B , and k takes $B'' := \beta(B')$ to B . In more detail, to construct j , we may choose B' to be an n -cube within B , so that j consists of a (cubical) contraction within B and the identity elsewhere. To construct k , we observe that B and B'' are homeomorphic, and such a homeomorphism may be extended to all of \mathbb{R}^n by extending over the complements, which are punctured discs by the Schoenflies theorem.

Then the composition $k \circ \beta \circ j^{-1}: T^n \setminus \{\text{pt}\} \looparrowright \mathbb{R}^n$ is still an immersion, which now takes B to itself. By modifying the construction above, we further assume that $\alpha|_B = \text{Id}$. Compose this immersion with a radial squeeze R fixing B so that the resulting immersion

$$\alpha := R \circ k \circ \beta \circ j^{-1}: T^n \setminus \{\text{pt}\} \looparrowright \mathbb{R}^n$$

has $\alpha(T^n \setminus 2\mathring{A}) \subseteq D^n$. Here we are using that $T^n \setminus 2\mathring{A}$ is compact and therefore has bounded image under $k \circ \beta \circ j^{-1}$.

STEP 6. Choose $\varepsilon > 0$ as required in the statement of the theorem.

Let us denote $D_\theta(x) := \{y \mid d(x, y) < \theta\}$. We will choose ε in several steps.

- (1) Choose $\varepsilon_1 > 0$ such that $\alpha|_{D_{2\varepsilon_1}(x)}$ is a homeomorphism for every $x \in T^n \setminus \mathring{A}$.

Namely, choose for every $x \in T^n \setminus \mathring{A}$ an open neighborhood $U_x \cong \mathbb{R}^n$ such that $\alpha|_{U_x}$ is a homeomorphism; this is an open cover of the compact space $T^n \setminus \mathring{A}$, so has a finite Lebesgue number $2\varepsilon_1$ (meaning that any $D_{2\varepsilon_1}(x)$ is contained in a member of the cover).

- (2) Choose $\varepsilon_2 > 0$ so that $D_{\varepsilon_2}(\alpha(x)) \subseteq \alpha(D_{\varepsilon_1}(x))$ for every $x \in T^n \setminus \mathring{A}$.

Namely, consider the map

$$\begin{aligned} T^n \setminus \mathring{A} &\rightarrow \mathbb{R}_{>0} \\ x &\mapsto \varepsilon_x := d(\alpha(x), \mathbb{R}^n \setminus \alpha(D_{\varepsilon_1}(x))). \end{aligned}$$

Above ε_x is positive for each x since $D_{\varepsilon_1}(x)$ and hence $\alpha(D_{\varepsilon_1}(x))$ is open, so $\mathbb{R}^n \setminus \alpha(D_{\varepsilon_1}(x))$ is closed.

LEMMA 15.9. *The above map is continuous.*

We defer the proof of the lemma to the end of this step. Since $T^n \setminus \mathring{A}$ is compact, we may choose $z \in T^n \setminus \mathring{A}$ that realises the minimum of the above function. In particular, this minimum is nonzero and we define $\varepsilon_2 := \varepsilon_z > 0$.

- (3) Choose $\varepsilon_3 > 0$ with $\varepsilon_3 < \varepsilon_2$ and so that if $y \in \mathbb{R}^n$ satisfies $|y - \alpha(x)| < \varepsilon_3$ for some $x \in T^n \setminus 2\mathring{A}$, then $y \in \alpha(T^n \setminus \mathring{A})$.

This is achieved by taking

$$\varepsilon_3 < \min \left\{ \varepsilon_2, d(\alpha(T^n \setminus 2\mathring{A}), \mathbb{R}^n \setminus \alpha(T^n \setminus \mathring{A})) \right\}.$$

Since $\alpha(T^n \setminus 2\mathring{A})$ is compact and $\mathbb{R}^n \setminus \alpha(T^n \setminus \mathring{A})$ is closed, their mutual distance is positive so $\varepsilon_3 > 0$.

- (4) Finally, define the required $\varepsilon > 0$ by setting $\varepsilon := \frac{\varepsilon_3}{2}$. Observe that the only input in the definition of ε is the map α .

Proof of Lemma 15.9. Fix $\eta > 0$ and $x \in T^n \setminus \mathring{A}$. The map $\alpha|_{\overline{D_{2\varepsilon_1}(x)}}$ is uniformly continuous by the Heine-Cantor theorem since $\overline{D_{2\varepsilon_1}(x)}$ is compact. So there exists $\delta > 0$ such that $d(p, q) < \delta$ for $p, q \in D_{2\varepsilon_1}(x)$ implies that $d(\alpha(p), \alpha(q)) < \frac{\eta}{2}$. Assume that $0 < \delta < \varepsilon_1$.

CLAIM. *If $d(p, q) < \delta < \varepsilon_1$ for $p, q \in T^n \setminus \mathring{A}$ then for all $z \in \partial D_{\varepsilon_1}(p)$ there exists $z' \in \partial D_{\varepsilon_1}(q)$ so that $d(z, z') < \delta$.*

We defer the proof of the claim to the end of this step. Given $y \in T^n \setminus \mathring{A}$ with $d(x, y) < \delta$, we want to show $|\varepsilon_x - \varepsilon_y| < \eta$. Since $\varepsilon_x := d(\alpha(x), \mathbb{R}^n \setminus \alpha D_{\varepsilon_1}(x))$, there exists $z \in \partial D_{\varepsilon_1}(x)$ with $\varepsilon_x = d(\alpha(x), \alpha(z))$. Choose, using the subclaim, some $z' \in \partial D_{\varepsilon_1}(y)$ with $d(z, z') < \delta$. Then

$$\begin{aligned} \varepsilon_y &:= d(\alpha(y), \mathbb{R}^n \setminus \alpha D_{\varepsilon_1}(y)) \leq d(\alpha(y), \alpha(z')) \\ &\leq d(\alpha(y), \alpha(x)) + d(\alpha(x), \alpha(z)) + d(\alpha(z), \alpha(z')) \\ &< \frac{\eta}{2} + \varepsilon_x + \frac{\eta}{2} = \eta + \varepsilon_x \end{aligned}$$

Here we have used the fact that $z, z' \in \overline{D_{2\varepsilon_1}(x)}$, since $z \in \partial D_{\varepsilon_1}(x)$ and $z' \in \partial D_{\varepsilon_1}(y)$, along with $d(x, z') \leq d(x, y) + d(y, z') < \delta + \varepsilon_1 < 2\varepsilon_1$.

A similar proof shows that $\varepsilon_x < \varepsilon_y + \eta$. This completes the proof of the lemma. \square

Proof of the claim. Since $\delta < \varepsilon$, by the definition of ε_1 we know that $\alpha|_{D_{\varepsilon_1}(p) \cup D_{\varepsilon_1}(q)}$ is a homeomorphism onto its image, since $D_{\varepsilon_1}(p) \cup D_{\varepsilon_1}(q) \subseteq D_{2\varepsilon_1}(p)$. In the upcoming proof, we will therefore assume that we are working in \mathbb{R}^n .

In case $z \in \partial D_{\varepsilon_1}(q)$, we just choose $z' = z$.

The next possibility is that $z \in \overset{\circ}{D}_{\varepsilon_1}(q)$. Let z' be the intersection point of the ray starting at q and passing through z , with $\partial D_{\varepsilon_1}(q)$ (so $q < z < z'$). Then

$$d(z, p) = \varepsilon_1 \leq d(p, q) + d(q, z) < \delta + d(q, z)$$

so $\varepsilon_1 - \delta < d(q, z)$. Then

$$\varepsilon_1 - \delta + d(z, z') < d(q, z) + d(z, z') = d(q, z') = \varepsilon_1$$

so $d(z, z') < \delta$.

The final possibility is that $z \in \mathbb{R}^n \setminus \overline{D_{\varepsilon_1}(q)}$. Then let z' be the point of intersection of the ray from p to z , with $\partial D_{\varepsilon_1}(q)$. Then

$$\varepsilon_1 = d(z', q) \leq d(z', p) + d(p, q) < d(z', p) + \delta$$

so $\varepsilon_1 - \delta < d(z', p)$. So

$$\varepsilon_1 - \delta + d(z, z') < d(z', p) + d(z, z') = d(p, z) = \varepsilon_1$$

so $d(z, z') < \delta$, as needed. \square

STEP 7. Define the embedding $\hat{h}: T^n \setminus 2\overset{\circ}{A} \hookrightarrow T^n \setminus \overset{\circ}{A}$ that fits into the bottom square of the diagram in (15.2).

Recall from the hypothesis that we are given a homeomorphism $h: \mathbb{R}^n \rightarrow \mathbb{R}^n$ such that $|h(x) - x| < \varepsilon$ for every $x \in D^n$. Define

$$\begin{aligned} \hat{h}: T^n \setminus 2\overset{\circ}{A} &\hookrightarrow T^n \setminus \overset{\circ}{A} \\ x &\mapsto \alpha|_{B_{\varepsilon_1}(x)}^{-1} \circ h \circ \alpha|_{B_{\varepsilon_1}(x)}(x). \end{aligned}$$

CLAIM. The function \hat{h} is well-defined.

Proof of claim. By definition of the immersion α , we know that $\alpha(T^n \setminus 2\overset{\circ}{A}) \subseteq D^n$. As a consequence, by our assumption on h , we know that for every $x \in T^n \setminus 2\overset{\circ}{A}$, we have $|h(\alpha(x)) - \alpha(x)| < \varepsilon < \varepsilon_3$. By definition of ε_3 , this implies that $h(\alpha(x)) \in \alpha(T^n \setminus \overset{\circ}{A})$. But now since, $|h(\alpha(x)) - \alpha(x)| < \varepsilon_3 < \varepsilon_2$ and using the definition of ε_2 , we deduce that $h(\alpha(x)) \in B_{\varepsilon_2}(\alpha(x)) \subseteq \alpha(B_{\varepsilon_1}(x))$. As, by construction, α is a homeomorphism on $B_{\varepsilon_1}(x)$, it makes sense to write $\alpha|_{B_{\varepsilon_1}(x)}^{-1}(h\alpha(x))$. \square

CLAIM. The function \hat{h} is continuous.

Proof of claim. It suffices to prove that for all $x \in T^n \setminus 2\overset{\circ}{A}$, there exists an open neighborhood U of x such that $\hat{h}|_U$ is continuous.

Fix $x \in T^n \setminus 2\overset{\circ}{A}$. Since α is continuous, there exists $\delta > 0$ such that $d(x, y) < \delta$ implies $d(\alpha(x), \alpha(y)) < \frac{\varepsilon_3}{2}$. Let $y \in U := B_{\varepsilon_1}(x) \cap B_{\delta}(x)$. Note that $B_{\varepsilon_1}(x) \cup B_{\varepsilon_1}(y) \subseteq B_{2\varepsilon_1}(x)$ and so $\alpha|_{B_{\varepsilon_1}(x) \cup B_{\varepsilon_1}(y)}$ is a homeomorphism.

We have that $h\alpha|_{B_{\varepsilon_1}(y)}(y) = h\alpha|_{B_{\varepsilon_1}(x)}(y) = h\alpha(y)$. Further

$$|h\alpha(y) - \alpha(x)| \leq |h\alpha(y) - \alpha(y)| + |\alpha(y) - \alpha(x)| \leq \frac{\varepsilon_3}{2} + \frac{\varepsilon_3}{2} = \varepsilon_3 < \varepsilon_2,$$

so $h\alpha(y) \in B_{\varepsilon_2}(\alpha(x)) \subseteq \alpha B_{\varepsilon_1}(x)$. As before, we know that $h\alpha(y) \in \alpha B_{\varepsilon_1}(y)$.

By definition, $\hat{h}(y) = \alpha|_{B_{\varepsilon_1}(y)}^{-1} h\alpha(y)$. Consider $y' := \alpha|_{B_{\varepsilon_1}(x)}^{-1} h\alpha(y)$. We assert that $y' = \hat{h}(y)$ since $y' \in B_{\varepsilon_1}(x)$ with $\alpha(y') = h\alpha(y)$, and $\hat{h}(y) \in B_{\varepsilon_1}(y)$ with $\alpha(\hat{h}(y)) = h\alpha(y)$, where $\alpha|_{B_{\varepsilon_1}(x) \cup B_{\varepsilon_1}(y)}$ is a homeomorphism.

In other words, $\widehat{h}|_U = \alpha|_{B_{\varepsilon_1}(x)}^{-1} \circ h \circ \alpha|_U$ where the latter is continuous as a restriction of a continuous map. This completes the proof of the claim. \square

CLAIM. *The function \widehat{h} is an embedding.*

Proof of claim. First we prove that \widehat{h} is injective. Assume by way of contradiction that $\widehat{h}(x) = \widehat{h}(y)$ for some $x \neq y$. Note that for every $z \in T^n \setminus 2\mathring{A}$, we have $\widehat{h}(z) \in B_{\varepsilon_1}(z)$. In particular, we have $d(\widehat{h}(x), x) < \varepsilon_1$ and $d(\widehat{h}(y), y) < \varepsilon_1$, or put differently, $x, y \in B_{\varepsilon_1}(\widehat{h}(x))$ because we assumed that $\widehat{h}(x) = \widehat{h}(y)$. Since $\alpha|_{B_{\varepsilon_1}(\widehat{h}(x))}$ is a homeomorphism (by definition of ε_1) and $x \neq y$, we deduce that $\alpha(x) \neq \alpha(y)$. Since h is a homeomorphism, this implies that $h(\alpha(x)) \neq h(\alpha(y))$. Using the definition of \widehat{h} , this can be written as $\alpha(\widehat{h}(x)) \neq \alpha(\widehat{h}(y))$. This contradicts the fact that $\widehat{h}(x) = \widehat{h}(y)$, and therefore shows that \widehat{h} is injective.

As a continuous, injective map from a compact space to a Hausdorff space \widehat{h} is further a closed map, and therefore by the closed map lemma it is an embedding. \square

Finally, we note that \widehat{h} and h agree on $\widetilde{B} := [\varepsilon_3, \frac{1}{2} - \varepsilon_3]^n \subseteq B \subseteq T^n \setminus 2\mathring{A}$. To see this observe that α is fixed on B , and thus for $x \in \widetilde{B}$, we have that $h(x) \in B$ since $|h\alpha(x) - \alpha(x)| = |h(x) - x| < \frac{\varepsilon_3}{2}$. Since α is fixed on B , $\alpha|_B(h(x)) = h(x)$ so $\widehat{h}(x) = \alpha|_B^{-1}(h(x)) = h(x)$ for $x \in \widetilde{B}$.

STEP 8. *Extend the embedding $\widehat{h}: T^n \setminus 2\mathring{A} \hookrightarrow T^n \setminus \mathring{A}$ to a homeomorphism $\bar{h}: T^n \xrightarrow{\cong} T^n$, as in the middle two squares of the diagram in (15.2).*

Note that $\widehat{h}(\partial 3A)$ is a bicollared $(n-1)$ -sphere in T^n . By Schoenflies theorem for the n -torus for $n \geq 3$ (Proposition 15.7), this sphere bounds an embedded ball in T^n ; since $\widehat{h}(T^n \setminus 3\mathring{A})$ is clearly not a ball, the other component of $T^n \setminus \widehat{h}(\partial 3A)$, call it C , must be homeomorphic to a ball. We can now use the Alexander coning trick (Proposition 15.3.0) to extend the homeomorphism $\widehat{h}|_{T^n \setminus 3\mathring{A}}$ of S^{n-1} to a homeomorphism $\bar{h}: T^n \xrightarrow{\cong} T^n$ of D^n , as required (that is, over $3A$ in the domain and C in the codomain). We leave it to the reader to consider the cases $n \leq 2$.

STEP 9. *Show that \bar{h} is isotopic to the identity Id_{T^n} .*

Since the universal cover of T^n is contractible, $\pi_i(T^n) = 0$ for $i > 1$ and thus T^n is a $K(\mathbb{Z}^n, 1)$. Now, homotopy classes of maps between Eilenberg-MacLane spaces correspond to the induced maps on the homotopy groups. Since \bar{h} may not preserve basepoints, we must consider the induced map on the outer automorphism group of the fundamental group (since changing the basepoint corresponds to an inner automorphism). Now, as $\pi_1(T^n)$ is abelian, it suffices to show that \bar{h} is homotopic to Id_{T^n} it suffices to prove that \bar{h} preserves free homotopy classes of loops.

To this end, consider a copy γ of $S^1 \times \{*\} \times \dots \times \{*\} \subseteq T^n \setminus 3\mathring{A}$ and let us show that $\bar{h}(\gamma)$ is freely homotopic to γ . Since we have $\alpha(\bar{h}(\gamma)) = h(\alpha(\gamma))$ it will suffice to check the following.

CLAIM. *There is a homotopy $\Gamma: S^1 \times [0, 1] \rightarrow \mathbb{R}^n$ from $\Gamma_0 = h(\alpha(\gamma))$ to $\Gamma_1 = \alpha(\gamma)$ such that Γ_t is at most distance ε for all $t \in [0, 1]$.*

Indeed, such a homotopy can be lifted to a free homotopy from $\widehat{h}(\gamma)$ (and thus also from $\bar{h}(\gamma)$) to γ , as desired.

Proof of claim. For all $y \in S^1$ we have $d(h\alpha(y), \alpha(\gamma)) \leq d(h\alpha(y), \alpha(y)) < \varepsilon$, for our chosen constant $\varepsilon := \frac{\varepsilon_3}{2}$ from Step 6. Therefore, $h(\alpha(\gamma)) \subseteq N_\varepsilon(\alpha(\gamma)) \subseteq \alpha(T^n \setminus \mathring{A})$. We define Γ as the straight line homotopy

$$(y, t) \mapsto th(\alpha(y)) + (1-t)\alpha(y),$$

and observe that $\Gamma_t \subseteq N_\varepsilon(\alpha(\gamma)) \subseteq \alpha(T^n \setminus \mathring{A})$ for all $t \in [0, 1]$. Indeed, for all $y \in \gamma$ we have

$$d(F_t(y), \alpha(\gamma)) \leq d(F_t(y), \alpha(y)) = t|h\alpha(y) - \alpha(y)| < \varepsilon. \quad \square$$

STEP 10. *Conclude the proof.*

Define $\tilde{h}: \mathbb{R}^n \rightarrow \mathbb{R}^n$ to be the map on universal covering spaces induced by $\bar{h}: T^n \rightarrow T^n$, also ensuring that $B \subseteq \mathbb{R}^n$ is mapped onto $B \subseteq T^n$ by the “identity”. Indeed, recall that the universal covering map $e: \mathbb{R}^n \rightarrow T^n$ denotes the exponential map, so this is in a way automatic by our identification of S^1 with $[0, 1] / \sim$.

Since \bar{h} is isotopic to the identity, by Lemma 15.5 the induced homeomorphism $\tilde{h}: \mathbb{R}^n \rightarrow \mathbb{R}^n$ on the universal covers is bounded distance from the identity. By Proposition 15.2 we deduce that \tilde{h} is isotopic to $\text{Id}_{\mathbb{R}^n}$.

On the other hand, we claim that h and \tilde{h} agree on the ball

$$\tilde{B} := [2\varepsilon, \frac{1}{2} - 2\varepsilon] \subseteq B := [0, \frac{1}{2}]^n \subseteq T^n \setminus 3\mathring{A}.$$

Indeed, let $x \in \tilde{B}$. Then $h(x) \in B$ because $|h(x) - x| < \varepsilon$ and $\alpha(x) = x$ and $\alpha|_B(h(x)) = h(x)$, as α fixes B . Now the definition of \hat{h} now gives

$$\hat{h}(x) = \alpha|_B^{-1} h \alpha(x) = \alpha|_B^{-1} h(x) = h(x).$$

implying also $\tilde{h}(x) = h(x)$. Consequently, \tilde{h} and h are isotopic by Proposition 15.3.v, and so h is also isotopic to the identity. This concludes the proof of Černavskii-Kirby Theorem 15.4. \square

15.2.1. Recap of the torus trick. Since the proof in the previous section contained many details, we recap its salient features. See Fig. 15.2.

We began with an immersion α into \mathbb{R}^n of the punctured torus $T^n \setminus \text{pt}$, which has specified regions B and $A \subseteq 2A \subseteq 3A$. We chose ε so that the image of $T^n \setminus 2\mathring{A}$ under h lies within the unit disc D^n , for any $h \in \text{Homeo}(\mathbb{R}^n)$ satisfying $|h(x) - x| < \varepsilon$ for all $x \in D^n$. This enabled us to define the lift $\hat{h}: T^n \setminus 2\mathring{A} \rightarrow T^n \setminus \mathring{A}$, see the middle row in Fig. 15.2.

Then by the Schoenflies theorem and the Alexander trick we extended $\hat{h}|_{T^n \setminus 3\mathring{A}}$ to a homeomorphism of the whole torus, $\bar{h}: T^n \rightarrow T^n$. We checked that \bar{h} is homotopic to Id_{T^n} , as T^n is a $K(\mathbb{Z}^n, 1)$ and, roughly speaking, h does not move generators of $\pi_1(T^n)$ too much.

Finally, \bar{h} induces a homeomorphism \tilde{h} of \mathbb{R}^n which only moves fundamental domains by a small amount, so it is bounded distance from the identity, and therefore is isotopic to the $\text{Id}_{\mathbb{R}^n}$. On the other hand, we arranged that \tilde{h} and h agree on an open subset of B , so by an Alexander isotopy h and \tilde{h} are isotopic. Therefore, we conclude that h is isotopic to $\text{Id}_{\mathbb{R}^n}$, as desired.

15.3. Local contractibility

As mentioned at the beginning of this section, the key use of Theorem 15.4 is in proving that $\text{Homeo}(\mathbb{R}^n)$ is locally contractible.

Definition 15.10. A space X is *locally contractible* at $x \in X$ if for every neighbourhood $U \ni x$ there is a neighbourhood $x \in V \subseteq U$ and a map $H: V \times [0, 1] \rightarrow U$ such that $H(y, 0) = y$ and $H(y, 1) = x$ for all $y \in V$. We say X is *locally contractible* if the previous is true at every $x \in X$.

COROLLARY 15.11 ([Č73],[Kir69]). $\text{Homeo}(\mathbb{R}^n)$ is locally contractible.

Proof. For $\varepsilon, \delta > 0$, let D_δ^n be the closed disc of radius δ at the origin and define

$$V(D_\delta^n, \varepsilon) := \{f \in \text{Homeo}(\mathbb{R}^n) \mid d(f(x), x) < \varepsilon \text{ for every } x \in D_\delta^n\}.$$

This is a neighbourhood of $\text{Id}_{\mathbb{R}^n} \in \text{Homeo}(\mathbb{R}^n)$ under compact open topology – actually, such sets comprise a basis for the compact open topology on $\mathcal{C}(M, N)$, see Exercise 15.2 below.

Given $U \ni x$ choose ε, δ such that $V(D_\delta^n, \varepsilon) \subseteq U$. Our goal is to produce a homotopy

$$H: V(D_\delta^n, \varepsilon) \times [0, 1] \rightarrow V(D_\delta^n, \varepsilon) \subseteq U$$

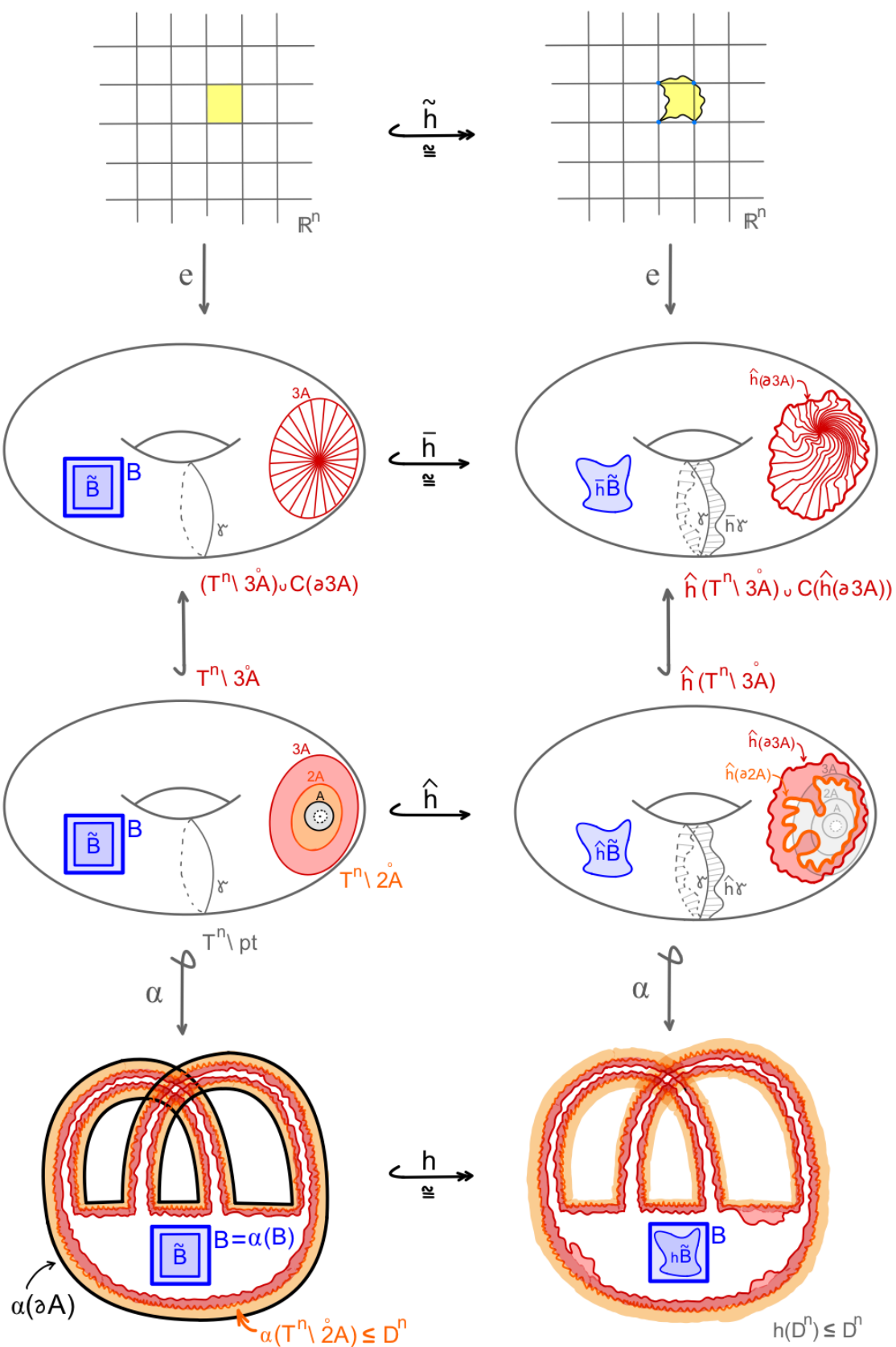

FIGURE 15.2. Recap of the proof of Theorem 15.4.

such that $H_0 = \text{Id}$ and $H_1 = \{\text{Id}_{\mathbb{R}^n}\}$. In other words, for $h \in V(D_\delta^n, \varepsilon)$ the path $H_t(h)$ is an isotopy from h to $\text{Id}_{\mathbb{R}^n}$. Note that Theorem 15.4 provides such paths, but it remains to see that they glue together into a continuous map H , i.e. we need to make sure that all constructions in the proof of Theorem 15.4 were *canonical* in terms of h .

This can be done, see ? for details. In particular, the application of Schoenflies theorem in Step 4 is also canonical, meaning that the map

$$\text{Emb}^{\text{bicoll}}(S^{n-1}, S^n) \rightarrow \text{Emb}(D^{n-1}, S^n)$$

given by the Schoenflies theorem is continuous. For Brown's proof of that theorem, this was shown carefully by Gauld [Gau71].

Therefore, $\text{Homeo}(\mathbb{R}^n)$ is locally contractible at $\text{Id}_{\mathbb{R}^n}$. The rest of the proof is completed by the next exercise. \square

EXERCISE 15.1. (PS7.2) Let M be a manifold. Show that $\text{Homeo}(M)$ is locally contractible at each $f \in \text{Homeo}(M)$ if and only if it is locally contractible at Id_M .

EXERCISE 15.2. (PS7.1) Let M and N be manifolds. Let d be a metric on N . Show that the collection of sets of the form

$$W(f, K, \varepsilon) := \{f \in \mathcal{C}(M, N) \mid d(f(x), g(x)) < \varepsilon \text{ for all } x \in K\}$$

where $K \subseteq M$ is compact and $\varepsilon > 0$ is a basis for the compact open topology on $\mathcal{C}(M, N)$.

Let us point out that $\text{Homeo}(\mathbb{R}^n)$ is not globally contractible.

EXERCISE 15.3. (PS6.2)

- (i) The space of homeomorphisms of \mathbb{R}^2 is not contractible.
- (ii) The space of orientation preserving homeomorphisms of \mathbb{R}^2 is not contractible.

Hint: recall from Corollary 7.5 that $\text{ev}: M \times \text{Homeo}(M) \rightarrow M$, $\text{ev}(x, f) = f(x)$ is continuous, and from Lemma 8.12 that $\text{Homeo}_0(\mathbb{R}^2) \hookrightarrow \text{Homeo}(\mathbb{R}^2)$ is a homotopy equivalence; then construct a loop of homeomorphisms that does not contract to a point.

Remark 15.12. Kneser [Kne26] (see also [Fri73]) showed that $\text{Homeo}(\mathbb{R}^2) \simeq O(2)$. Further, we know that $O(2) \cong S^1 \sqcup S^1$.

Later in the course we will sketch the proof that $\text{Homeo}(M)$ for every compact manifold M is locally contractible [Č73, EK71a]. However, the corresponding fact for noncompact manifolds is not true, as demonstrated by the following exercise.

EXERCISE 15.4. (PS7.3) For $i \in \mathbb{N}$, let B_i denote the ball of radius $\frac{1}{3}$ centred at $(i, 0) \in \mathbb{R}^2$. Define $M := \mathbb{R}^2 \setminus \bigcup_i B_i$.

Let $h_i \in \text{Homeo}(M)$ be a homeomorphism which is the identity outside the disc of radius 1 centred at $(i + \frac{1}{2}, 0)$, and which maps B_i to B_{i+1} and vice versa. Why does such a homeomorphism exist?

Show that h_i is not homotopic to the identity for any i , but $\{h_i\}$ converges to the identity in the compact open topology on $\text{Homeo}(M)$.

Conclude that $\text{Homeo}(M)$ is not locally contractible, nor locally path connected.

The torus trick in low dimensions

Daniel Galvin, Weizhe Niu, and Benjamin Matthias Ruppik

Structure of the chapter. The goal of Section 16.1 is to give an exposition of three explicit constructions of immersions of punctured tori that appeared in the literature. We start by visualizing such an immersion in dimensions 2 and 3 in Section 16.1.1. Then we look at Milnor's inductive argument in Section 16.1.2, continue with Ferry's explicit version in Section 16.1.3 and finish with Barden-Siebenmann's construction Section 16.1.4 as presented in Rushing's work.

Hatcher's application to smooth structures on surfaces is taken up in Section 16.2. PL structures on 3-manifolds following Hamilton are treated in Section 16.3.

16.1. Explicit immersions of the n -torus into \mathbb{R}^n

An important ingredient for the torus trick, is an immersion of a punctured n -torus into \mathbb{R}^n . For this section, we work in the smooth category, where a *smooth immersion* is a smooth map $f: M \rightarrow N$ between the smooth manifolds M, N such that its differential $T_x(f): T_x(M) \rightarrow T_{f(x)}(N)$ is injective at every point $x \in M$. An equivalent condition would be to require that the map f is locally a smooth embedding. Note that an injective immersion is not necessarily a (global) embedding, because an embedding is required to be a homeomorphism onto its image. Wrapping a half-open interval onto a circle, $[0, 1) \rightarrow S^1$ is an example of this (an injective immersion which is not a homeomorphism onto its image).

There is a notion of a *topological immersion* between topological manifolds, where the defining property is that every point in the source has a neighborhood on which the map restricts to an embedding.

Remark 16.1. A *smooth submersion* $s: M \rightarrow N$ between the smooth manifolds M, N is a smooth map $f: M \rightarrow N$ between the smooth manifolds M, N such that its differential $T_x(f): T_x(M) \rightarrow T_{f(x)}(N)$ is surjective at every point $x \in M$. For a map between manifolds of the same dimension, the notions of immersion and submersion coincide. In particular, our immersions $\mathbb{T}^n - \{\text{pt}\} \hookrightarrow \mathbb{R}^n$ are in this codimension 0 setting. In his letter Milnor uses the 'submersion' terminology, but here we plan to stick with 'immersion'.

The existence of an immersion $\mathbb{T}^n - \{\text{pt}\} \hookrightarrow \mathbb{R}^n$ can be concluded from Smale-Hirsch theory, which is a tool to study the homotopy type of embedding spaces. In particular, a theorem of Hirsch claims that a smooth, open, parallelizable n -manifold (for example, a punctured n -torus) can be smoothly immersed into \mathbb{R}^n .

16.1.1. Pictures in dimensions 2 and 3. We write \mathbb{T}_0^n for the n -torus where an n -cell has been removed. Observe that it does not make a difference whether we remove a point or a closed n -cell.

The 2-torus \mathbb{T}^2 has a handle decomposition with one 0-handle, two 1-handles and one 2-handle. An immersion of the 0-handle $D^2 \times D^0$ together with the two 1-handles ($D^1 \times D^1$ attached along $S^0 \times D^1$) into the plane is shown in Figure 16.1. Since the images of the 1-handles cross, this map is not injective. We can also describe the image of this immersion as the union of two annuli $S^1 \times [0, 1] \cup S^1 \times [0, 1]$, where one of the overlapping squares takes the role of the 0-handle, while the other square is the region of intersection of the 1-handles.

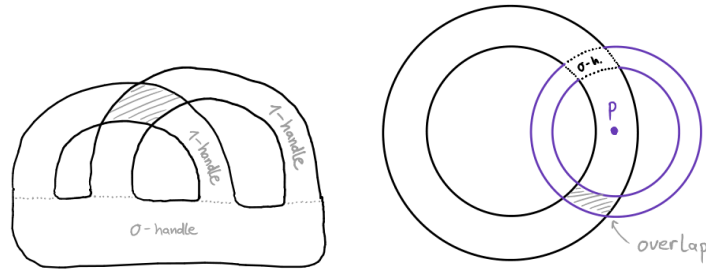

FIGURE 16.1. Two pictures of an immersion of a punctured 2-torus into the plane.

Trying to visualize the 3-dimensional case

$$\mathbb{T}^3 - \mathbb{D}^3 \hookrightarrow \mathbb{R}^3$$

Can embed 1-skeleton into \mathbb{R}^3

\rightsquigarrow Now have to add the three 2-handles

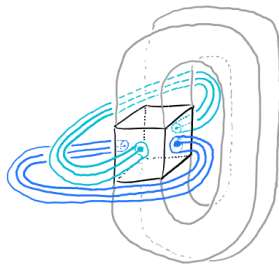

$$\mathbb{T}^3 = \underbrace{0\text{-h.} \cup \bigcup^3 1\text{-h.} \cup \bigcup^3 2\text{-h.}}_{\mathbb{T}^3 - \mathbb{D}^3} \cup 3\text{-h.}$$

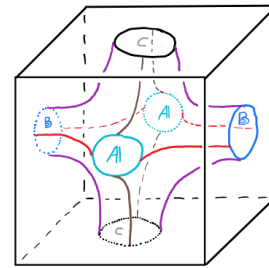

Heegaard diagram of \mathbb{T}^3 :

another circle labeled C on the outside

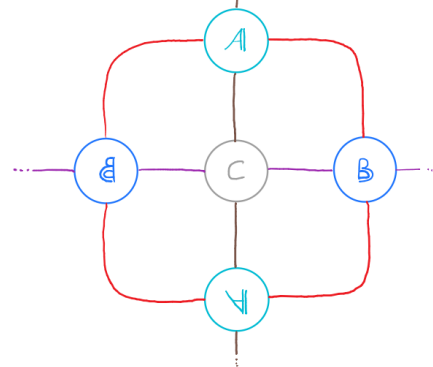

FIGURE 16.2. Embedding the 1-skeleton of the 3-torus into 3-space.

The 3-torus \mathbb{T}^3 has a handle decomposition with one 0-handle, three 1-handles, three 2-handles (which are attached along pairwise commutators of the 1-handles) and a single 3-handle. We would like to immerse everything except the top-dimensional handle into 3-space. The 1-skeleton

$$h^0 \cup h_a^1 \cup h_b^1 \cup h_c^1 = D^3 \bigcup_{S^0 \times D^2}^3 D^1 \times D^2$$

homeomorphic to a 3-dimensional handlebody $\natural^3 S^1 \times D^2$ can be embedded into \mathbb{R}^3 as for example in Figure 16.2. Attaching the 2-handles $D^2 \times D^1$ along $S^1 \times D^1$ so that the attaching spheres $S^1 \times \{0\}$ read off the words $aba^{-1}b^{-1}$, $bc b^{-1}c^{-1}$ and $cac^{-1}a^{-1}$ will introduce (self-)intersections.

The following indication of an immersion $\mathbb{T}^3 - 3\text{-handle} \hookrightarrow \mathbb{R}^3$ is inspired by Ryan Budney's answer [Bud]. We would like to describe the image of the immersion as the union

$$S^1 \times S^1 \times [0, 1] \cup S^1 \times [0, 1] \times S^1 \cup [0, 1] \times S^1 \times S^1$$

of thickened tori (the interval factor $[0, 1]$ corresponding to the thickening), where we have to arrange the overlaps so that we can suitably interpret them as handles and double or triple point

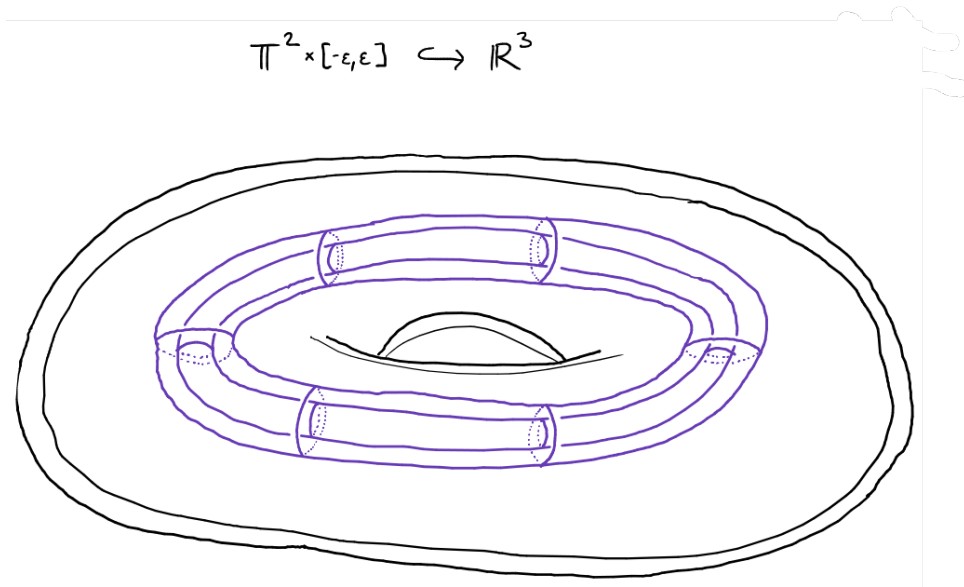

FIGURE 16.3. Thickened 2-torus with boundary of tubular neighborhood around longitude. This looks like the spin of the immersion in Figure 16.1.

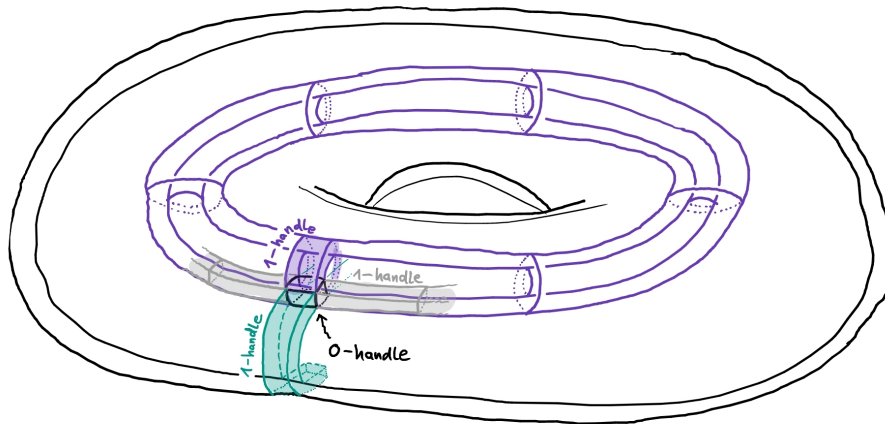

FIGURE 16.4. Seeing part of the handle decomposition of the 3-torus in the overlaps of the immersion in Figure 16.3.

regions. For example Figure 16.3, shows an immersion of the union $S^1 \times S^1 \times [0, 1] \cup S^1 \times [0, 1] \times S^1$ with overlaps compatible to the handle decomposition of the 3-torus, see also Fig. 16.4. We would still have to add another 2-handle to the picture to complete the immersion of the punctured 3-torus, but we will stop here and move on to the proofs giving general constructions.

16.1.2. Milnor’s inductive argument.

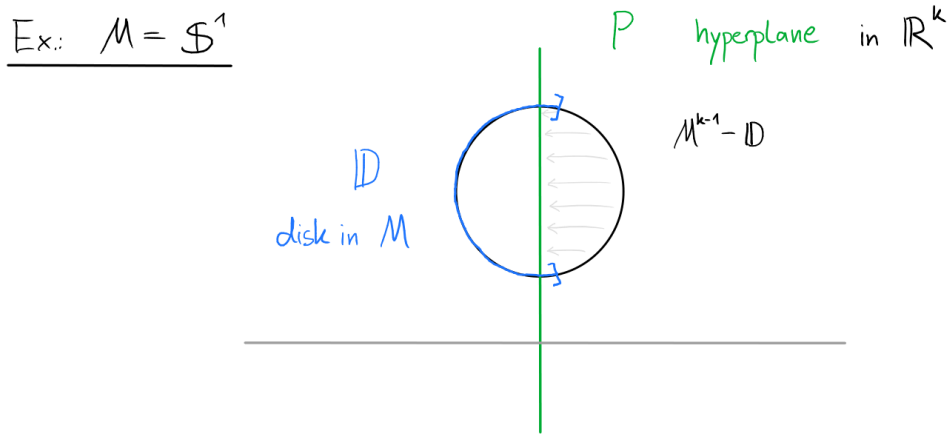

FIGURE 16.5. The circle S^1 satisfies Milnor’s property \mathfrak{J} .

Main idea: Milnor’s letter printed in [KS77b, Essay I, Appendix B]

- Suppose M_k can be embedded in Euclidean space so that projection onto a hyperplane defines an immersion $M_k - \text{disk} \hookrightarrow \mathbb{R}^k$
- Will show that then also $M_{k+1} = M_k \times S^1$ has this condition
- Starting with $M_1 = S^1$ inductively get immersions of punctured torus

Slogan: Spin and perturb (now can immerse by projecting), or keep going to spin and perturb (and project), ...

Definition 16.2 (Property \mathfrak{J}). Let M^{k-1} be a smooth manifold. We say that M satisfies Property \mathfrak{J} if it has a codimension 1 embedding into Euclidean space $M^{k-1} \hookrightarrow \mathbb{R}^k$ so that for some smooth closed disk $\mathbb{D} \subset M$ there exists a $k - 1$ -dimensional hyperplane $P \subset \mathbb{R}^k$ so that the orthogonal projection $\text{pr}_P: M - \mathbb{D} \rightarrow P$ is an immersion.

PROPOSITION 16.3. *The circle S^1 satisfies property \mathfrak{J} .*

Proof. The proof is by picture in Figure 16.5. □

THEOREM 16.4. *If M satisfies Property \mathfrak{J} , then so does the product with a circle $M \times S^1$.*

Let us assume the inductive Theorem 16.4 for now, then the immersion of the punctured torus can be built as follows. Inductively, the n -dimensional torus $\mathbb{T}^n = (S^1)^{\times n-1} \times S^1$ satisfies Property \mathfrak{J} , so that the orthogonal projection

$$\mathbb{T}_0^n \cong \mathbb{T}^n - \mathbb{D} \rightarrow \mathbb{R}^{n+1} \xrightarrow{\text{pr}_P} P \cong \mathbb{R}^n$$

gives the immersion of the punctured torus.

Proof of Theorem 16.4. Let us make some simplifying assumptions on the embedding of $M^{k-1} \subset \mathbb{R}^k$: We will arrange it so that we can pick the hyperplane $P = \{x_1 = 0\}$ for the immersion of $M - \mathbb{D}$ and that the image of M lies in the open “slab” $\{0 < x_k < \beta\}$ of \mathbb{R}^k .

Think of \mathbb{R}^{k+1} with its open book decomposition with binding \mathbb{R}^{k-1} and pages the half-spaces \mathbb{R}_+^k , as in Figure 16.6. We can “spin” the subset $M \subset \mathbb{R}^k$ to obtain an embedding

$$M \times S^1 \hookrightarrow \mathbb{R}^{k+1}$$

$$((x_1, \dots, x_{k-1}, x_k), \theta) \mapsto (x_1, \dots, x_{k-1}, x_k \cdot \cos \theta, x_k \cdot \sin \theta)$$

Here $\theta \in [0, 2\pi]/0 \sim 2\pi \cong S^1$ is the coordinate on the circle.

We still need a slight deformation of this embedding to check property \mathfrak{J} , and find the hyperplane into which we want to immerse.

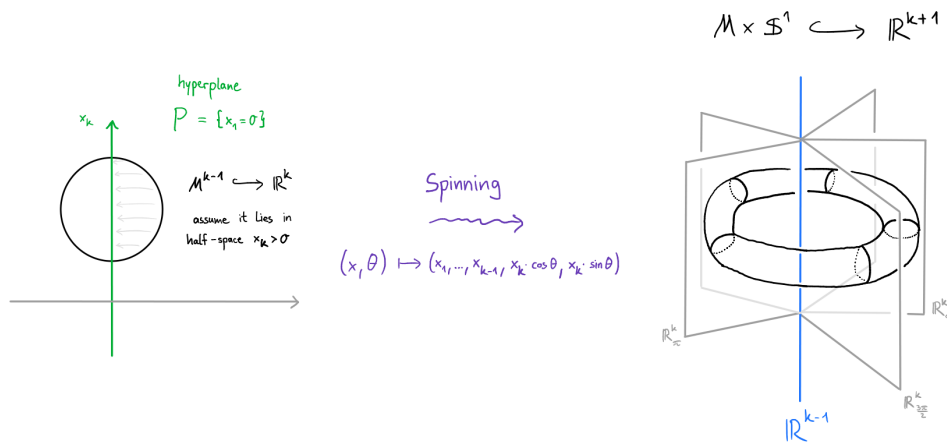

FIGURE 16.6. Spinning the embedding $M^{k-1} \hookrightarrow \mathbb{R}^k$ (assuming it lies in the half-space $\{x_k > 0\}$) to obtain an embedding $M^{k-1} \times S^1 \hookrightarrow \mathbb{R}^{k+1}$.

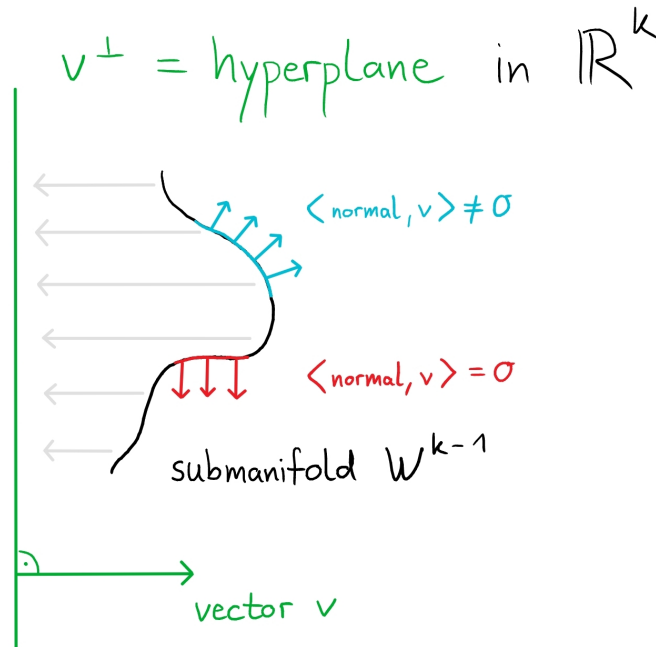

FIGURE 16.7. Checking that the projection to a hyperplane is an immersion of a submanifold by looking at the normal vector.

Let us set up the notation to describe projections to hyperplanes: A normal vector $v \in \mathbb{R}^{k+1}$ determines the hyperplane $v^\perp = \{x \in \mathbb{R}^{k+1} \mid \langle v, x \rangle = 0\}$. Orthogonal projection to v^\perp will give an immersion of a submanifold $W \subset \mathbb{R}^{k+1}$ as long as the normal vector p_w to W at $w \in W$ is not orthogonal to the vector v describing the hyperplane v^\perp , see Figure 16.7. In other words, in our perturbation attempts we want to choose an orthogonal projection direction v so that $\langle p_w, v \rangle > 0$ at all points $w \in W$.

As an Ansatz, look in the direction of the first unit vector $e_1 = (1, 0, \dots, 0) \in \mathbb{R}^{k+1}$, and then tilt your head slightly away from the last unit vector $e_{k+1} = (0, \dots, 0, 1) \in \mathbb{R}^{k+1}$. We will try to project to the plane orthogonal to

$$v = e_1 - \alpha e_{k+1}$$

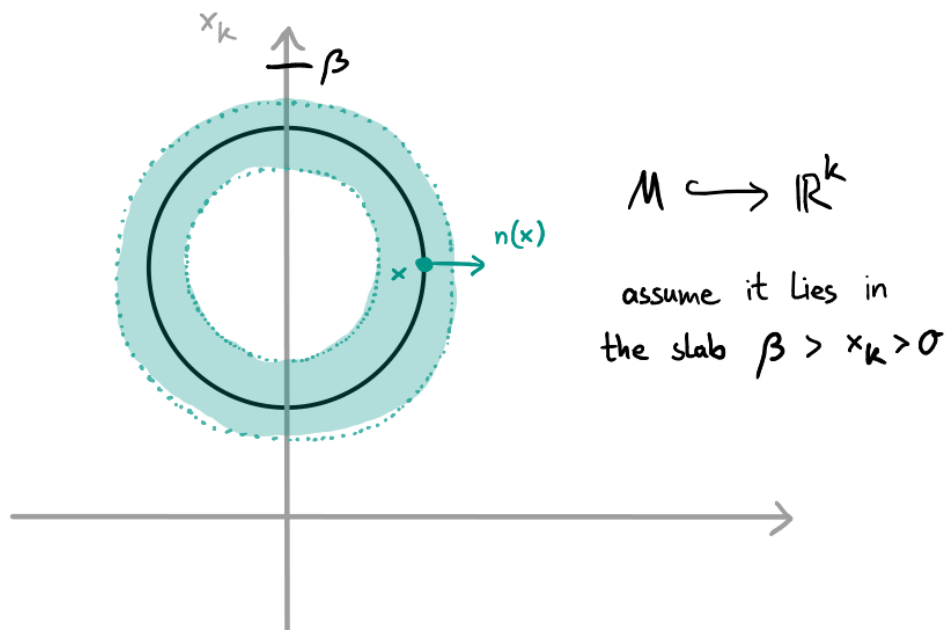

FIGURE 16.8. Embedding a neighborhood $M^{k-1} \times (-\varepsilon, \varepsilon)$ into \mathbb{R}^k .

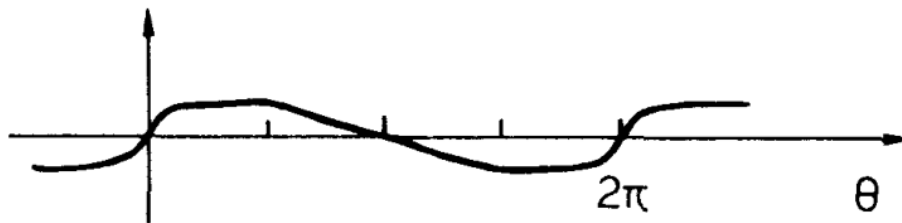

FIGURE 16.9. An example for the function $t: S^1 \rightarrow (-\varepsilon, \varepsilon)$. (© Milnor's letter in [KS77b])

$$(M \times S^1) - (D \times [\eta, 2\pi - \eta]) \rightarrow v^\perp \text{ hyperplane}$$

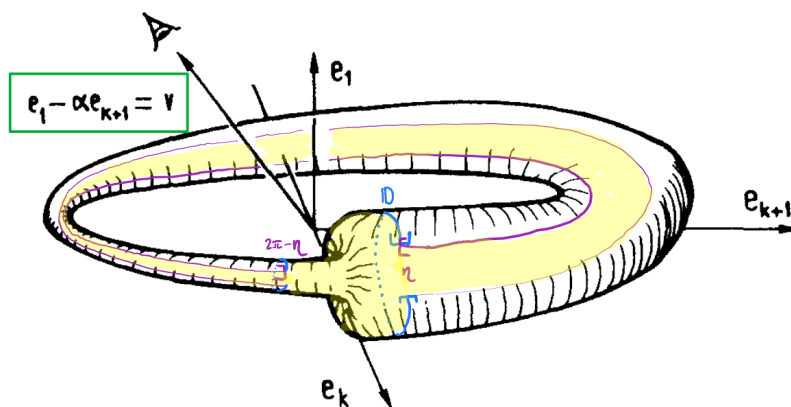

FIGURE 16.10. Schematic of Milnor's perturbation of the spin. (© Milnor's letter in [KS77b])

The second summand B is non-negative by our construction of the function t . So on this set, $\langle p(x, \theta), v \rangle > 0$

- For all $x \in M$, but $\theta = 0$: Here $A \geq -\beta$ and $B \geq \alpha \frac{2\beta}{\alpha}$. This shows $\langle p(x, 0), v \rangle > 0$ and by continuity $\langle p(x, \theta), v \rangle > 0$ for all θ which are sufficiently close to 0, say for $|\theta| \leq \eta$, $\eta > 0$.

In conclusion, projecting to the hyperplane v^\perp is an immersion on

$$(M \times S^1) - (\mathbb{D} \times [\eta, 2\pi - \eta]) \looparrowright v^\perp$$

which is $M \times S^1$ without a disk. This concludes the proof that $M \times S^1$ satisfies property \mathfrak{J} . \square

Remark 16.5. Milnor cites the paper [Gra74] which contains another explicit construction of an immersion, but unfortunately we were not able to track down this reference.

16.1.3. Ferry's explicit version.

Main idea: [Fer74b]

- Define a “standard embedding” $\mathbb{T}^n \times (0, 1) \hookrightarrow \mathbb{R}^{n+1}$ via explicit coordinates
- Perturb the image of $\mathbb{T}^n \times \{0\}$ in its normal bundle
- projection to \mathbb{R}^n is an immersion in a neighborhood of the $(n-1)$ -skeleton of \mathbb{T}^n (which is a punctured torus)

Slogan: Spin iteratively until we embedded the torus, then after one perturbation at the end we can project to the first coordinates

We will use the coordinates

$$\vec{\theta} = (\theta_1, \dots, \theta_n) \in \mathbb{T}^n = (S^1)^{\times n}$$

with $\theta_i \in S^1 \cong [0, 2\pi]/0 \sim 2\pi$ to describe points on the n -torus, where we usually pick the representative to lie in the interval $\theta_i \in [0, 2\pi)$.

We will now describe the standard embedding of $\mathbb{T}^n \times (-1, 1)$ into \mathbb{R}^{n+1} via an iterated spinning construction. The idea of the spinning is the same as appeared in Milnor's construction, but the difference here is that we will perturb the image only once at the end, and not after each spinning step. The advantage of this is that we can write down the spinning in explicit coordinates.

Start with the standard embedding of the thickened 1-torus

$$\begin{aligned} S^1 \times (-1, 1) &\hookrightarrow \mathbb{R}^2 \\ (\theta_1, t) &\mapsto ((1+t) \cdot \cos \theta_1, (1+t) \cdot \sin \theta_1 + 2) \end{aligned}$$

Nos suppose we have constructed an embedding

$$\begin{aligned} \mathbb{T}^n \times (-1, 1) &\hookrightarrow \mathbb{R}^{n+1} \\ (\vec{\theta}, t) &\mapsto (f_1(\vec{\theta}, t), \dots, f_n(\vec{\theta}, t), f_{n+1}(\vec{\theta}, t)) \end{aligned}$$

where we assume that we have shifted the last coordinate so that $f_{n+1}(\vec{\theta}, t) > 0$. This assumption on the last coordinate is the reason for the $+2$ in the standard embedding of the 1-torus. Then by spinning we can construct a new embedding

$$\begin{aligned} \mathbb{T}^{n+1} \times (-1, 1) &\hookrightarrow \mathbb{R}^{n+2} \\ (\vec{\theta}, t) &\mapsto (f_1(\vec{\theta}, t), \dots, f_n(\vec{\theta}, t), f_{n+1}(\vec{\theta}, t) \cdot \cos \theta_{n+1}, f_{n+1}(\vec{\theta}, t) \cdot \sin \theta_{n+1},) \end{aligned}$$

where after each spinning stage, add 2^n to the last coordinate to force the last coordinate to be > 0 . Here are the first steps in this construction:

$$\begin{aligned} \mathbb{T}^1 \times (-1, 1) &\hookrightarrow \mathbb{R}^2 \\ (\vec{\theta} = (\theta_1), t) &\mapsto ((1+t) \cdot \cos \theta_1, (1+t) \cdot \sin \theta_1 + 2) \end{aligned}$$

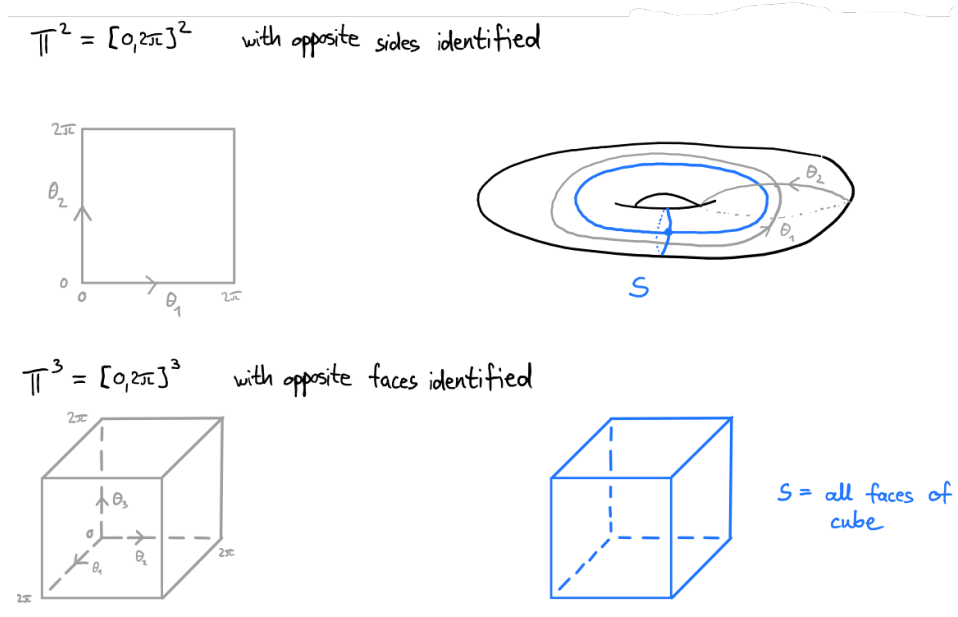

FIGURE 16.11. The 1-skeleton of the 2-torus $\mathbb{T}^2_{(1)}$ and the 2-skeleton of the 3-torus $\mathbb{T}^3_{(2)}$.

$$\mathbb{T}^2 \times (-1, 1) \hookrightarrow \mathbb{R}^3$$

$$(\vec{\theta} = (\theta_1, \theta_2), t) \mapsto ((1+t) \cdot \cos \theta_1, ((1+t) \cdot \sin \theta_1 + 2) \cdot \cos \theta_2, ((1+t) \cdot \sin \theta_1 + 2) \cdot \sin \theta_2 + 4)$$

$$\mathbb{T}^3 \times (-1, 1) \hookrightarrow \mathbb{R}^4$$

$$(\vec{\theta} = (\theta_1, \theta_2, \theta_3), t) \mapsto ((1+t) \cdot \cos \theta_1, ((1+t) \cdot \sin \theta_1 + 2) \cdot \cos \theta_2, ((1+t) \cdot \sin \theta_1 + 2) \cdot \sin \theta_2 + 4) \cdot \cos \theta_3, (((1+t) \cdot \sin \theta_1 + 2) \cdot \sin \theta_2 + 4) \cdot \sin \theta_3 + 8)$$

In the circle coordinates, we can explicitly describe the $(n-1)$ -skeleton of the n -torus as

$$\mathbb{T}^n_{(n-1)} = \{(\theta_1, \dots, \theta_n) \in \mathbb{T}^n \mid \theta_i = 0 \text{ for some } i \in \{1, \dots, n\}\}$$

Observe that an open neighborhood of $\mathbb{T}^n_{(n-1)} \subset \mathbb{T}^n$ is everything except a closed disk in the n -cell of \mathbb{T}^n . See also Figure 16.11 for an illustration in low dimensions.

Our goal now will be to perturb $\mathbb{T}^n \times \{0\}$ in the normal t -direction so that projecting to the first n coordinates, i.e. to $\mathbb{R}^n \times \{0\} \subset \mathbb{R}^{n+1}$, is an immersion on an open tubular neighborhood of $\mathbb{T}^n_{(n-1)}$. See Figure 16.12 for a schematic illustration. Here the perturbation contains $\varepsilon > 0$ as a small positive parameter, and we pick the function

$$\varphi: \mathbb{T}^n \rightarrow \mathbb{R}$$

$$\vec{\theta} \mapsto \frac{\sin \theta_1 \cdot \sin \theta_2 \cdot \dots \cdot \sin \theta_n}{2^n} + \frac{\sin \theta_2 \cdot \dots \cdot \sin \theta_n}{2^{n-1}} + \dots + \frac{\sin \theta_{n-1} \cdot \sin \theta_n}{2^2} + \frac{\sin \theta_n}{2}$$

to determine by how much we wiggle in the normal direction. Putting this together, we have the following:

$$\mathbb{T}^n \times (-1, 1) \rightarrow \mathbb{R}^{n+1}$$

$$(\vec{\theta}, t) \mapsto (f_1(\vec{\theta}, t), \dots, f_n(\vec{\theta}, t), f_{n+1}(\vec{\theta}, t))$$

$$\rightsquigarrow \text{pert: } \mathbb{T}^n \rightarrow \mathbb{R}^{n+1}$$

$$\vec{\theta} \mapsto (f_1(\vec{\theta}, \varepsilon \cdot \varphi(\vec{\theta})), \dots, f_n(\vec{\theta}, \varepsilon \cdot \varphi(\vec{\theta})), f_{n+1}(\vec{\theta}, \varepsilon \cdot \varphi(\vec{\theta})))$$

$$\rightsquigarrow \text{pr} \circ \text{pert: } \mathbb{T}^n \rightarrow \mathbb{R}^n$$

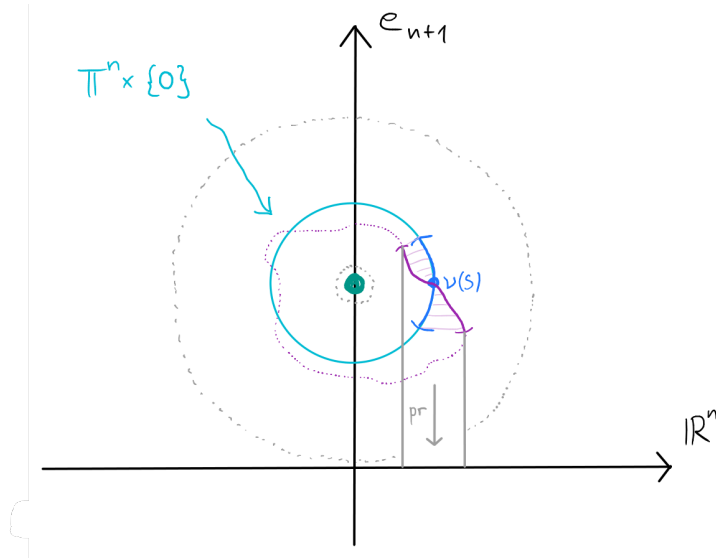

FIGURE 16.12. Schematic of the projection of the perturbed torus in Ferry’s proof

$$\vec{\theta} \mapsto (f_1(\vec{\theta}, \varepsilon \cdot \varphi(\vec{\theta})), \dots, f_n(\vec{\theta}, \varepsilon \cdot \varphi(\vec{\theta})))$$

Showing that this composition of the perturbation with the projection has injective differential in a neighborhood of the $(n - 1)$ -skeleton would prove that it restricts to an immersion of $\mathbb{T}^n - D^n$ into \mathbb{R}^n as desired.

We will skip the calculation, but now it is possible to compute that the differential of the map $\text{pr} \circ \text{pert}$ at points $\vec{\theta} \in \mathbb{T}_{(n-1)}^n$ and $t = \varepsilon \cdot \varphi(\vec{\theta}) = 0$ is given by

$$\frac{-\varepsilon}{2^n} \cdot \det(Df)$$

where Df is the determinant of the Jacobian of the standard embedding of the n -torus into \mathbb{R}^n . For details of the computation see Barden’s paper [Fer74b]. Here we will be content with observing that this Jacobian of the standard embedding is non-singular, and so by continuity of the differential the determinant of $D(\text{pr} \circ \text{pert})$ is non-zero in a small open neighborhood of $\mathbb{T}_{(n-1)}^n$ and for small parameters ε . This concludes our exposition of Ferry’s construction.

16.1.4. Barden’s inductive proof.

Main idea: [Rus73a, Immersion Lemma 5.6.1]

- Inductively build immersions $\mathbb{T}^n \times [0, 1] \looparrowright \mathbb{R}^n \times [0, 1]$
- they restrict to a product map on $(\mathbb{T}^n - n\text{-cell}) \times [0, 1]$
- the first factor of the product map gives the desired immersion

Slogan: Add an extra dimension useful for the induction, then restrict to the first factor

This section closely follows Chapter 5 in Rushing’s book [Rus73a]. The proof originates from Barden, with contributions to the exposition by Edwards and Siebenmann.

We write \mathbb{T}_0^n for the n -torus where an n -cell has been removed.

PROPOSITION 16.6 ((Bard_n) = Inductive statement in dimension n). *There exists an immersion*

$$f: \mathbb{T}^n \times [-1, 1] \looparrowright \mathbb{R}^n \times [-1, 1]$$

such that the restriction to $\mathbb{T}_0^n \times [-1, 1]$ is a product map, that is

$$f|_{\mathbb{T}_0^n \times [-1, 1]} = \alpha \times \text{Id}_{[-1, 1]}: \mathbb{T}_0^n \times [-1, 1] \looparrowright \mathbb{R}^n \times [-1, 1]$$

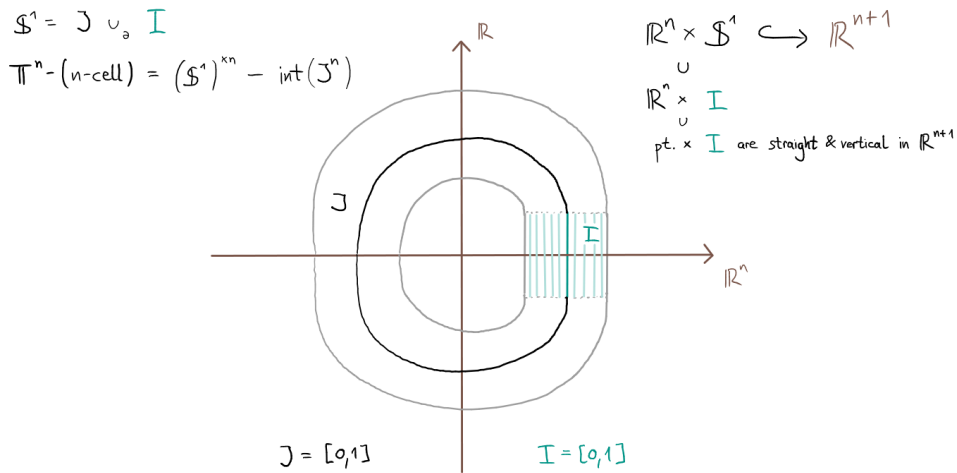

FIGURE 16.13. Setting up the notation for the subsets of the n -torus, where the circle factors are $S^1 = I \cup_{\partial} J$. Also pictures is an embedding $\mathbb{R}^n \times S^1 \hookrightarrow \mathbb{R}^{n+1}$, where the I -fibres $\{\text{pt.}\} \times I \subset \mathbb{R}^n \times I \subset \mathbb{R}^n \times S^1$ are straight and vertical in \mathbb{R}^{n+1} .

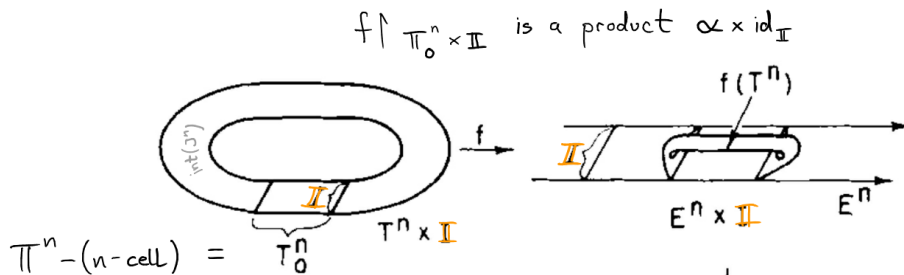

FIGURE 16.14. Base case: An immersion $f: \mathbb{T}^1 \times [-1, 1] \looparrowright \mathbb{R}^1 \times [-1, 1]$ such that the restriction to $\mathbb{T}_0^1 \times [-1, 1] = I \times [-1, 1]$ is a product map. (© [Rus73a])

We will prove Proposition 16.6 inductively. Then $\alpha: \mathbb{T}_0^n \looparrowright \mathbb{R}^n$ is the immersion of the punctured torus that we are looking for.

PROPOSITION 16.7 ((Bard₁) = Base case). *There exists an immersion*

$$f: \mathbb{T}^1 \times [-1, 1] \looparrowright \mathbb{R}^1 \times [-1, 1]$$

such that the restriction to $\mathbb{T}_0^1 \times [-1, 1]$ is a product map, that is

$$f|_{\mathbb{T}_0^1 \times [-1, 1]} = \alpha \times \text{Id}_{[-1, 1]}: \mathbb{T}_0^1 \times [-1, 1] \looparrowright \mathbb{R}^1 \times [-1, 1]$$

We will use this opportunity to set up some notation for the inductive step, also see Figure 16.13. We will write the circle $S^1 = I \cup_{\partial} J$ as the endpoint-union of two interval segments $I = [-1, 1] = J$. Then, we can use J^n as the n -cell of the product $\mathbb{T}^n = (S^1)^{\times n}$, and identify $\mathbb{T}_0^n = \mathbb{T}^n - J^n$. Figure 16.13 also shows an embedding $\mathbb{R}^n \times S^1 \hookrightarrow \mathbb{R}^{n+1}$ where the I -fibres $\{\text{pt.}\} \times I \subset \mathbb{R}^n \times I \subset \mathbb{R}^n \times S^1$ are straight and vertical in \mathbb{R}^{n+1} .

Proof of base case (Bard₁) in Proposition 16.7. The immersion which is a product on the punctured 1-torus is pictured in Figure 16.14. □

Proof sketch of the inductive step (Bard_n) \Rightarrow (Bard_{n+1}) for Proposition 16.6. Assume $f: \mathbb{T}^n \times [-1, 1] \looparrowright \mathbb{R}^n \times [-1, 1]$ is given so that $f|_{\mathbb{T}_0^n \times [-1, 1]} = \alpha \times \text{Id}_{[-1, 1]}: \mathbb{T}_0^n \times [-1, 1] \looparrowright \mathbb{R}^n \times [-1, 1]$

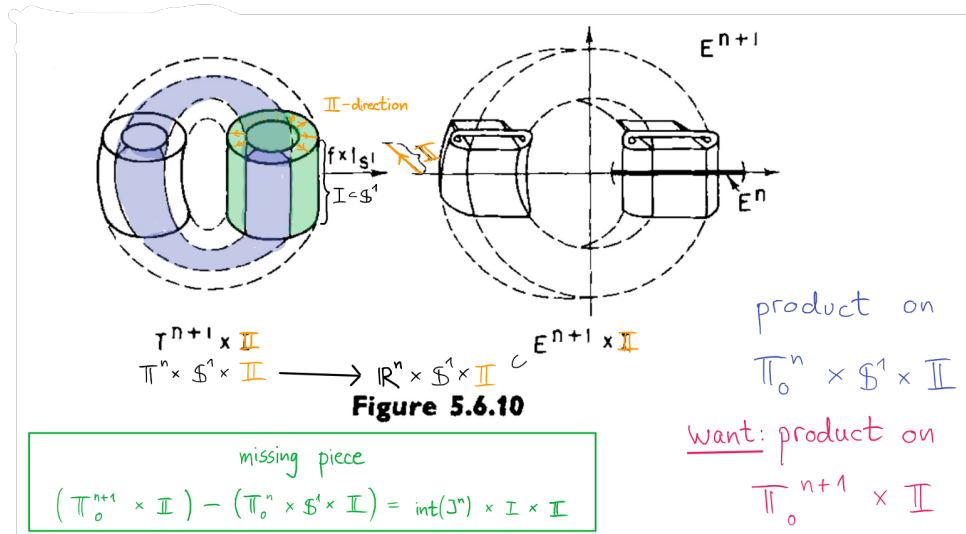

FIGURE 16.15. Inductive step. (© [Rus73a])

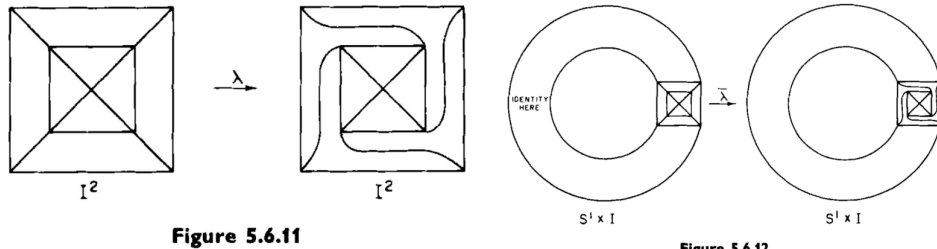

FIGURE 16.16. The homeomorphism $\lambda: [-1, 1]^2 \rightarrow [-1, 1]^2$ which is the identity on the boundary $\partial([-1, 1]^2)$, and a $\frac{\pi}{2}$ -rotation on the smaller square $[-\frac{2}{3}, \frac{2}{3}]^2$. On the right is a picture of extending the map via the identity to a homeomorphism $\bar{\lambda}: S^1 \times [-1, 1] \rightarrow S^1 \times [-1, 1]$. (© [Rus73a])

is a product map. By crossing with another circle factor and composing with the embedding $\mathbb{R}^n \times S^1 \hookrightarrow \mathbb{R}^{n+1}$ from Figure 16.13 we can construct an immersion

$$\tilde{f}: \mathbb{T}^n \times S^1 \times [-1, 1] \xrightarrow{f \times \text{Id}_{S^1}} \mathbb{R}^n \times S^1 \times [-1, 1] \hookrightarrow \mathbb{R}^{n+1} \times [-1, 1]$$

For an illustration of the inductive step, see Figure 16.15. Check that \tilde{f} is a product on $\mathbb{T}_0^n \times S^1 \times [-1, 1]$. We want to construct an immersion which is a product on $\mathbb{T}_0^{n+1} \times [0, 1]$, so we have to correct for this on the missing piece

$$(\mathbb{T}_0^{n+1} \times [0, 1]) - \mathbb{T}_0^n \times S^1 \times [-1, 1] = \text{Int } J^n \times I \times [-1, 1]$$

We will do this by conjugating with a 90 degree rotation on the $I \times [-1, 1]$ factor, which is possible because $\tilde{f}|_{\mathbb{T}_0^n \times I \times [-1, 1]}$ is a product on the $I \times [-1, 1]$ factor.

For convenience, assume that the map $f: \mathbb{T}^n \times [-1, 1] \looparrowright \mathbb{R}^n \times [-1, 1]$ satisfies $f(\mathbb{T}^n \times [-\frac{1}{2}, \frac{1}{2}]) \subset \mathbb{R}^n \times [-\frac{2}{3}, \frac{2}{3}]$. Now see Figure 16.16 for a description of the “rotation homeomorphism” $\bar{\lambda}: S^1 \times [-1, 1] \rightarrow S^1 \times [-1, 1]$ by which we will conjugate. With this setup, we consider the following immersion

$$h: \mathbb{T}^n \times S^1 \times [-1, 1] \looparrowright \mathbb{R}^{n+1} \times [-1, 1]$$

$$h = (\text{Id}_{\mathbb{R}^n} \times \bar{\lambda}^{-1}) \circ \tilde{f} \circ (\text{Id}_{\mathbb{T}^n} \times \bar{\lambda})$$

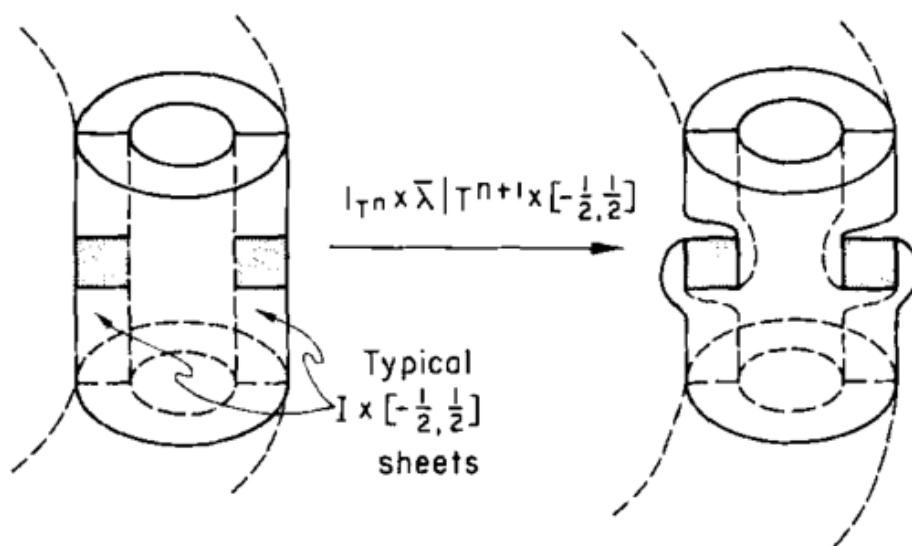

Figure 5.6.13

FIGURE 16.17. Conjugation with λ applied to several squares. (© [Rus73a])

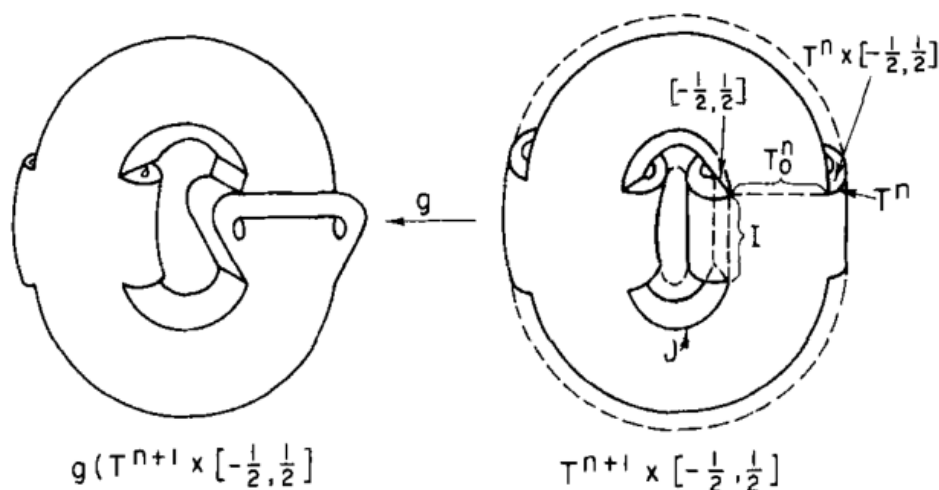

Figure 5.6.14

FIGURE 16.18. The global situation in the final construction. (© [Rus73a])

The remaining ideas are contained in Figure 16.17 and Figure 16.18, see the reference [Rus73a] for the concluding arguments. □

16.2. Torus trick for surfaces

A slogan that is often heard in manifold theory is that 'the categories are the same' in dimension ≤ 3 . That is to say there is no difference between smooth, PL, or topological manifolds in these low dimensions. The aim of this section is to elucidate this idea in dimension 2, i.e. for surfaces. This will be achieved via proving the following two theorems, the proofs of which will use the torus trick. The discussion will follow [Hat13b].

THEOREM 16.8. *Every topological surface can be given a smooth structure.*

THEOREM 16.9. *Every homeomorphism of smooth surfaces is isotopic to a diffeomorphism.*

Putting these two theorems together, we get the immediate corollary:

COROLLARY 16.10. *Every topological surface can be given a smooth structure, which is unique up to diffeomorphism.*

This result is the precise statement hiding behind the slogan ‘the categories are the same’. We can also use this result to classify topological surfaces, since it means that the topological classification immediately follows from the smooth classification of surfaces. The proofs of these theorems will use the handle smoothing theorem which we will state and use in Section 16.2.1.

16.2.1. Handle smoothing. Here we will state the handle smoothing theorem and use it to prove Theorem 16.8 and Theorem 16.9. We will prove the handle smoothing theorem in Section 16.2.3.

THEOREM 16.11. *Let n and k be non-negative integers such that $n + k = 2$ and let $h: B^k \times \mathbb{R}^n \rightarrow \mathbb{R}^2$ be a topological embedding which is smooth in a neighbourhood of $\partial(B^k \times \mathbb{R}^n)$. Then h may be (topologically) isotoped to a smooth embedding on $B^k \times B^n$, staying fixed near $\partial(B^k \times \mathbb{R}^n)$ and outside a larger neighbourhood of $B^k \times \{0\}$.*

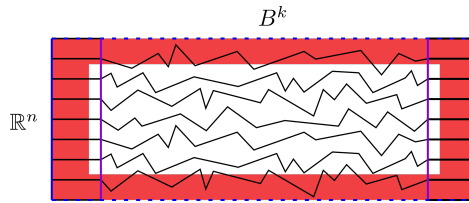

FIGURE 16.19. Smoothing a handle $B^k \times \mathbb{R}^n$ which is already smooth near $\partial B^k \times \mathbb{R}^n$, staying fixed in the red region.

LEMMA 16.12. *An open set $W \subset \mathbb{R}^2$ admits a triangulation such that the size of the simplices approaches 0 on the (topological) boundary of W .*

Proof. We prove this by simply constructing such a triangulation. Divide \mathbb{R}^2 into unit squares by drawing lines parallel to the x and y -axis.

- Step 1: Throw away all squares that lie entirely outside of W .
- Step 2: Divide squares that lie partially inside W into four $\frac{1}{2} \times \frac{1}{2}$ squares each.

Repeat these steps indefinitely (see Fig. 16.20). The union of the remaining squares is now W and the size of these squares approaches 0 on the (topological) boundary of W . We then turn this into a triangulation by adding a single vertex at the centre of every square and adding in a new edge connecting this central vertex to each other vertex on the square. \square

We now prove the existence of smooth structures on surfaces. Note that we always have local smooth structures on surfaces, induced by the standard Euclidean neighbourhoods about points. The difficulty is in piecing together all of these local structures into a single global structure.

Proof of Theorem 16.8. We first consider the closed case. Let S be a closed surface, and $h_i: \mathbb{R}^2 \rightarrow S$ be (topological) embeddings such that $h_i(\mathbb{R}^2)$, $i = 0, 1, 2, \dots$ form an open cover of S . We now proceed via induction, our base case being covered by the existence of local smooth structures. Assume there exists a smooth structure on $U_{n-1} = \bigcup_{i=1}^{n-1} h_i(\mathbb{R}^2)$, and we want to extend this to a smooth structure on $U_n = \bigcup_{i=1}^n h_i(\mathbb{R}^2)$. Let $W := h_n^{-1}(U_{n-1})$. Since h_n is continuous and U_{n-1} is open, W is an open set and we can use Lemma 16.12 to construct a

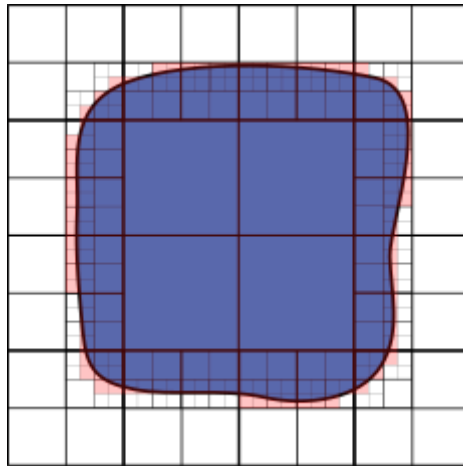

FIGURE 16.20. Four iterations of steps 1-2 shown for an open set in \mathbb{R}^2 (shown in blue). The squares that have not been thrown away are shaded in red.

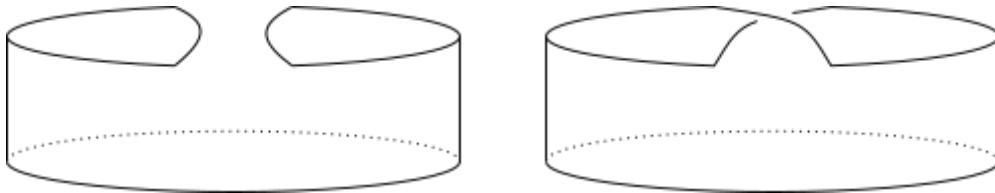

FIGURE 16.21. Pair of trousers (left) and twisted pair of trousers (right).

triangulation of W with the size of simplices approaching 0 on the (topological) boundary. This triangulation gives us an induced handle decomposition for W , and we can apply the handle smoothing theorem in turn on each handle to smooth h_n on W . This gives us an isotopy h_n^t such that $h_n^0 = h_n|_W$ and h_n^1 is smooth on W and we need to extend this isotopy onto all of \mathbb{R}^2 . This is possible since the size of the simplices of our triangulation approaches 0 on the (topological) boundary of W , which means that the isotopy approaches the constant isotopy, and thus can be extended onto all of \mathbb{R}^2 via the constant isotopy. Now we have extended the smooth structure onto U_n , and this completes the induction.

The case with boundary is similar, but starts with the existence of a collar neighbourhood of the boundary. This collar is of the form $\partial M \times I$, where ∂M is a closed 1-manifold. Since all 1-manifolds are smoothable (see Section 16.2.4), we know that we can give ∂M a smooth structure and can extend this onto the whole collar. At this point the proof proceeds identically to the closed case, where we start by setting $U_1 := \partial M \times I$. \square

We now move to proving the uniqueness of smooth structures on surfaces, but first we state and prove another lemma.

LEMMA 16.13. *A smooth surface S admits a smooth triangulation.*

By a *smooth triangulation* we mean there exists a simplicial complex S , such that S is homeomorphic to X and the inclusion map $\Delta \rightarrow X$ is a smooth embedding for every simplex $\Delta \in S$. We say that a map $\Delta \rightarrow X$ is smooth if there exists a smooth extension of the map to an open set $U \supset X$ in \mathbb{R}^2 .

Proof. The idea of this proof is to construct a smooth cellulation which we then turn into a smooth triangulation. We start by picking a Morse function on our surface S . We can then cut along non-critical levels of our Morse function to cut our surface into smaller pieces. If we only

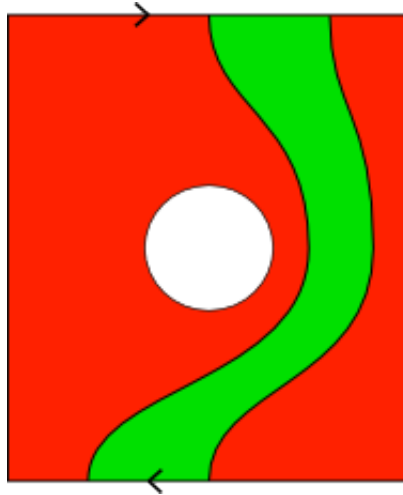

FIGURE 16.22. Twisted pair of trousers cut along a circle to give a Möbius band (green) and a normal pair of trousers (red).

allow a maximum of one critical point to lie between our cuts, then the pieces we can obtain are as follows: if no critical point lies between our cuts, we obtain an annulus; if one index 0 or 2 critical point lies between our cuts, we obtain a disc; if one index 1 critical point lies between our cuts, we obtain either a pair of trousers or a twisted pair of trousers, depending on whether the 1-handle was twisted when attached (see Figure 16.21). A twisted pair of trousers can be thought of as a punctured Möbius band, and so we can further cut a twisted pair of trousers into a regular pair of trousers and a Möbius band by cutting along a circle that winds twice around the band, avoiding the puncture (see Figure 16.22).

We now have a decomposition on S into discs, annuli, pairs of trousers, and Möbius bands. This can be turned into a smooth cellulation by adding in one vertex to each boundary circle on every piece, and then adding in edges depending on the type of piece. For discs, we add no edges; for annuli, we add a single edge connected the two vertices directly; for pairs of trousers, we add in two edges connecting two of the boundary circles to the third; for a Möbius band, we add in a single edge connecting the sole vertex to itself, winding all the way along the band. This cuts all of our pieces into polygons, giving us a smooth cellulation. We can then further cut these polygons into triangles by adding an extra vertex in the interior of each piece and connecting it to all other vertices by edges (this step isn't necessary for the Möbius band, which has already been cut into a triangle). This gives us the required smooth triangulation of S . \square

Proof of Theorem 16.9. Let $f: S \rightarrow S'$ be a homeomorphism of smooth surfaces. We want to show that f is isotopic to a diffeomorphism. We start by considering the closed case $\partial S = \emptyset$. Lemma 16.13 gives us a smooth triangulation of S . We can then apply Theorem 16.11 successively. First, we smooth f near the vertices of our triangulation. Every vertex in S has a B^2 neighbourhood which f (topologically) embeds inside a copy of $\mathbb{R}^2 \subset S'$ and hence we can use the Theorem 16.11 to smooth f on this neighbourhood. Next we smooth f near the edges of our triangulation in the analogous manner. Since f is already smooth near the vertices at the ends of each edge, we can isotop f to be smooth on a $B^1 \times B^1$ neighbourhood of the edge and the isotopy stays fixed near the vertices, hence keeping the smoothness of f that we have already achieved. The final step is to smooth f on the faces of our triangulation, and again we can do this precisely because we have already smoothed f near all of the edges and vertices of our triangulation. f is now locally a smooth embedding, and hence a local diffeomorphism. f is also

still injective by its construction and so is a global (topological) embedding of homeomorphic surfaces, and hence must be surjective. Therefore we have isotoped f to a global diffeomorphism.

Now assume ∂S is non-empty. Pick a smooth collar for S , and then glue on another smooth collar $\partial S \times I$, extending f onto it via the identity. We now have a smooth collar such that f is constant with respect to the collar parameter on a smaller sub-collar. Now f restricted to ∂S is a homeomorphism of smooth 1-manifolds and hence is isotopic to a diffeomorphism (see Section 16.2.4). We can then extend this isotopy onto the sub-collar such that it is constant on the internal boundary of the sub-collar, allowing us to extend the isotopy onto the rest of S as the constant isotopy. We now have that f is already smooth on a collar of S , and we can then proceed with exactly the same method for the empty boundary case to smooth f on the rest of S , provided that we ensure our smooth triangulation of S restricts to a smooth triangulation of the collar. \square

16.2.2. Studying surfaces using graphs. To prove the handle smoothing theorem, we will need to employ a number of techniques for dealing with smooth surfaces. In this section we will describe the general scheme in which this will be done, which develops the ideas used in the proof of Lemma 16.13.

Let S be a smooth surface, possibly with boundary and choose a Morse function f for S . As in the proof of Lemma 16.13, we cut along non-critical levels of f to obtain pieces P_i , which are discs, annuli, pairs of trousers or Möbius bands. Note that if we allow for non-compact surfaces, then we can get more types of pieces: open-discs, half-open discs ($D^1 \times \mathbb{R}$) etc., but the general idea is the same. We now have a decomposition of our surface into pieces P_i , which are joined together by circles which we will denote by C_j .

We now construct a graph from our surface. Let Γ_S be the graph such that Γ_S has one vertex for every piece P_i and two vertices are connected by an edge for each boundary circle C_j that they share. We then have a natural map $p: S \rightarrow \Gamma_S$ that maps product neighbourhoods of C_j to their corresponding edges and collapses the remaining portions of the P_j to their corresponding vertices (see Figure 16.23). Consider the induced map on fundamental groups $p_*: \pi_1(S) \rightarrow \pi_1(\Gamma_S)$. Since the pieces P_i are path-connected, we can construct well-defined loops in S (up to homotopy) mapping to any loops in Γ_S , so this map must be split surjective. Note that when choosing the segment of the loop in each piece P_i , if the piece is not simply-connected the segment should be chosen such that it is trivial in $\pi_1(P_i)$. Hence, we can conclude that there exists a subgroup of $\pi_1(S)$ which is isomorphic to $\pi_1(\Gamma_S)$.

The strength of this viewpoint is that we can simplify our graphs homotopically and have the simplifications pull back to simplifications of our surface. If we have an index-1 vertex on Γ_S , we can remove it and its corresponding edge, leaving a homotopy equivalent graph. Now we see how this change can be pulled back to S . At each C_j , the pieces are glued together via a diffeomorphism of S^1 , which up to isotopy are either the identity or the inverse map $z \mapsto z^{-1} = z^*$. When one of the pieces corresponds to an index-1 vertex, this piece must be a disc and this diffeomorphism makes no difference to the diffeomorphism type of the resulting surface. This means that we can alter our Morse function to remove this disc piece, provided that the other piece was not also a disc. If the disc was attached to an annulus, we simply decrease the level at which the index-2 critical point occurs, whereas if the disc was attached to a pair of trousers, we cancel out the index-2 critical point with the index-1 critical point in the pair of trousers. The upshot of this is that we can always simplify finite sub-trees in Γ_S , with the result representing a diffeomorphic surface to S . We illustrate this technique, and end this subsection, with an example.

Example 16.14. Consider a topological torus with some smooth structure \mathcal{S} , denoted $T_{\mathcal{S}}$. We want to show that $T_{\mathcal{S}}$ is diffeomorphic to the standard torus T , and we will do this using the graph $\Gamma_{T_{\mathcal{S}}}$. Since $\pi_1(T_{\mathcal{S}}) \cong \mathbb{Z} \oplus \mathbb{Z}$ is abelian, and $\pi_1(\Gamma_{T_{\mathcal{S}}})$ is a free subgroup, we know that $\pi_1(\Gamma_{T_{\mathcal{S}}})$ is isomorphic to either \mathbb{Z} or the zero group. If it is the zero group, then $\Gamma_{T_{\mathcal{S}}}$ is a tree

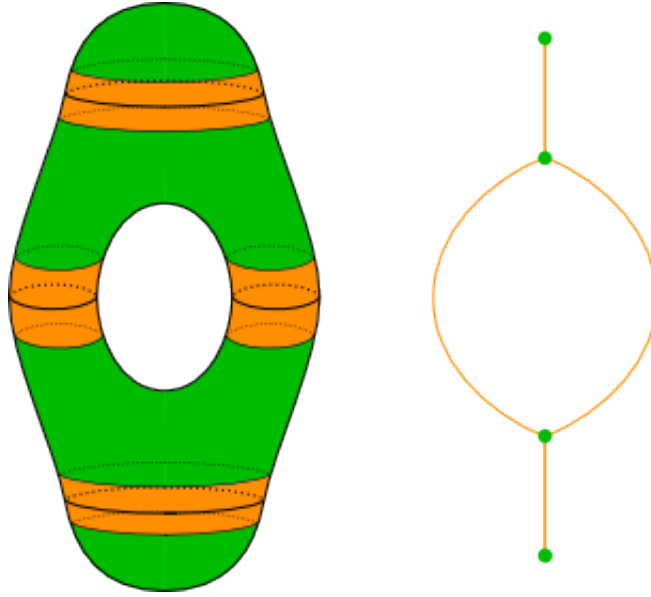

FIGURE 16.23. Constructing a graph from a torus, cut along four circles into four pieces.

and we can cancel sub-trees until we end up with the graph with two vertices connected by a single edge. This must correspond to T_S being diffeomorphic to a sphere, which cannot be true as the fundamental group of T_S is non-trivial. So, the group must be \mathbb{Z} , which implies that Γ_{T_S} is a circle with finitely many sub-trees attached. Again, we can cancel these sub-trees to obtain a circular graph, which corresponds to T_S being made of finitely many annuli glued together in a circle, corresponding to either a standard Klein bottle or the standard torus (depending on the type of the glueing diffeomorphisms on the C_j). Since $\pi_1(T_S)$ does not match that of a Klein bottle, we must conclude that T_S is diffeomorphic to the standard torus.

16.2.3. Proof of the handle smoothing theorem. We will now prove Theorem 16.11, using the techniques we have just developed along with the torus trick. We will take the cases $k = 0, 1, 2$ separately, as their proofs are very different.

Proof of Theorem 16.11.

$k = 0$ case, or 0-handle smoothing: It may be useful to refer to Fig. 16.24 throughout this proof to visualise the sequence of steps. We begin at the bottom of the diagram, and work our way up to the top. Let $h: B^0 \times \mathbb{R}^2 = \mathbb{R}^2 \rightarrow S$ be the embedding that we wish to smooth and suppose we are given a fixed (topological) immersion $T^2 \setminus * \hookrightarrow \mathbb{R}^2$. Such immersions were explicitly constructed in the previous section. We can pull back the smooth structure on S to give a smooth manifold structure on $T^2 \setminus *$ that we will denote as $(T^2 \setminus *)_S$. We want to be able to extend this to a smooth structure on the whole torus, but to do so we need to prove that it is standard near the puncture.

First, we create the graph Γ for $(T^2 \setminus *)_S$ as in Section 16.2.2. Since $\pi_1((T^2 \setminus *)_S)$ is finitely generated, $\pi_1(\Gamma)$ must be also, which means that there exists a finite subgraph Γ_0 such that the closure of $\Gamma \setminus \Gamma_0$ is a disjoint union of finitely many trees. The key here is that since $(T^2 \setminus *)_S$ has only one end, one and only one of these trees must be infinite. Simplify the graph by removing the finite trees and simplify the infinite tree by removing any finite subtrees. These simplifications are simultaneously realised on the surface, which means that there exists a compact set whose complement is diffeomorphic to $S^1 \times \mathbb{R}$, i.e. an infinite number of annuli glued together. This proves that the smooth structure was standard near the puncture, and hence we can extend our smooth structure onto T^2 to give T_S^2 .

$$\begin{array}{ccc}
 \mathbb{R}^2 & \xrightarrow{\tilde{G}} & \mathbb{R}^2 \\
 \uparrow & & \uparrow \\
 B^2 & \xrightarrow{G} & B^2 \\
 \uparrow & & \uparrow \\
 \mathbb{R}_S^2 & \xrightarrow{\tilde{g}} & \mathbb{R}^2 \\
 \downarrow & & \downarrow \\
 T_S^2 & \xrightarrow{g} & T^2 \\
 \uparrow & & \\
 (T^2 \setminus *)_S & & \\
 \downarrow \rho & & \\
 \mathbb{R}^2 & \xleftarrow{h} & S
 \end{array}$$

FIGURE 16.24. Torus trick diagram for the 0-handle case

From Example 16.14 we know that all smooth structures on a torus are diffeomorphic, so there exists a diffeomorphism $g: T_S^2 \rightarrow T^2$. We want to lift this diffeomorphism up to a diffeomorphism $\tilde{g}: \mathbb{R}_S^2 \rightarrow \mathbb{R}^2$ of the universal covers, but we first need to normalise g so that it induces the identity map on the fundamental groups. Firstly, we may assume that g maps the basepoint to the basepoint, by rotating the S^1 factors in either the domain or the codomain. Then, note that g being a diffeomorphism implies that the induced map on fundamental groups $\pi_1(g)$ is an isomorphism. $\pi_1(g)^{-1} \in GL_2(\mathbb{Z})$ corresponds naturally to diffeomorphism on T^2 given by the action of $GL_2(\mathbb{Z})$ on $T^2 = \mathbb{R}^2/\mathbb{Z}^2$. Post-composing g with this diffeomorphism allows us to assume that g induces the identity map on fundamental groups.

We now have lifted our diffeomorphism g to a diffeomorphism $\tilde{g}: \mathbb{R}_S^2 \rightarrow \mathbb{R}^2$. We would like to extend this to a homeomorphism $G: B^2 \rightarrow B^2$ that is the identity on the boundary. One way to prove that this is possible is to show that \tilde{g} is bounded, i.e. to show that the set $\{|\tilde{g}(x) - x| \mid x \in \mathbb{R}^2\}$ is bounded above. But this is easy, since we know that \tilde{g} is bounded on $[0, 1] \times [0, 1]$ by compactness, and thus is bounded on \mathbb{R}^2 by periodicity.

If we consider B^2 as the unit disc in \mathbb{R}^2 , we can then extend G onto \mathbb{R}^2 by extending via the identity to construct a map $\tilde{G}: \mathbb{R}^2 \rightarrow \mathbb{R}^2$. By the Alexander trick, we know this is (topologically) isotopic to the identity, so there exists an isotopy \tilde{G}_t where $\tilde{G}_1 = \tilde{G}$ and $\tilde{G}_0 = Id$. We now claim that $h_t = G_t^{-1} \circ h$ is the required isotopy that we wanted to construct originally. Clearly $h_0 = h$, so it suffices to show that h_1 is smooth near 0 and that $h_t = h$ far away from 0. Since \tilde{G}_t is the identity outside of B^2 , this second condition is obviously satisfied. To see why the first is satisfied, note that \tilde{G}_1 is a diffeomorphism from the smooth structure \mathcal{S} to the standard smooth structure near 0, and that h is (by definition) smooth on the \mathcal{S} smooth structure. This implies that h_1 is smooth near 0, completing the proof.

$k = 1$ case, or 1-handle smoothing: Let $h: B^1 \times \mathbb{R} \rightarrow S$ be a topological embedding that is already smooth near $\partial B^1 \times \mathbb{R}$. We want to smooth this embedding near $B^1 \times \{0\}$ with an isotopy that stays fixed near $\partial B^1 \times \mathbb{R}$ and outside some larger neighbourhood of $B^1 \times \{0\}$. We can pull the smooth structure on S back to $B^1 \times \mathbb{R}$ to give it a smooth structure which is standard near the boundary. Denote this smooth manifold by $(B^1 \times \mathbb{R})_S$.

We now construct a diffeomorphism $f: (B^1 \times \mathbb{R})_S \rightarrow B^1 \times \mathbb{R}$. Consider the projection $\pi: B^1 \times \mathbb{R} \rightarrow \mathbb{R}$. We can perturb this to a Morse function h on $(B^1 \times \mathbb{R})_S$ with $h = \pi$ near $\partial B^1 \times \mathbb{R}$, since π was already smooth there. Note that all of the critical points of h lie in

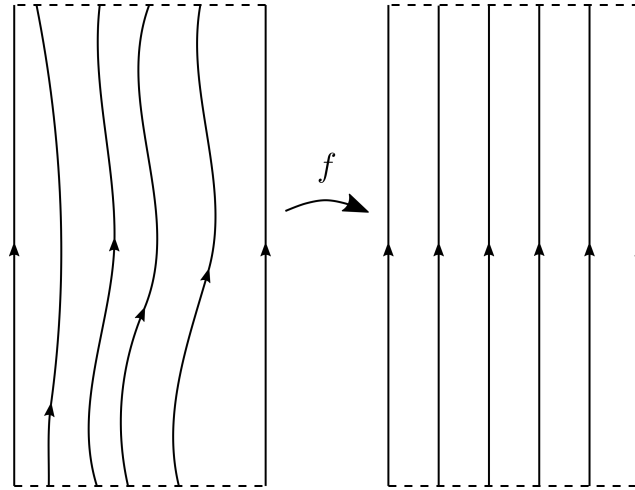

FIGURE 16.25. The diffeomorphism $f: (B^1 \times \mathbb{R})_S \rightarrow B^1 \times \mathbb{R}$ fixing a neighbourhood of $\partial B^1 \times \mathbb{R}$ and sending flow lines of h to flow lines of π .

the interior of the smooth manifold by construction. We then construct the graph Γ as in Section 16.2.2. Since $\pi_1(B^1 \times \mathbb{R}) = 0$, our graph must be a tree. Since $B^1 \times \mathbb{R}$ has two ends, this must be an infinite tree in two directions, with finite sub-trees attached. We can cancel out these finite sub-trees to leave Γ being homeomorphic to \mathbb{R} . Our Morse function h is correspondingly altered (staying fixed near $\partial B^1 \times \mathbb{R}$, to remove all critical points). We then use the flow lines of h to construct our required diffeomorphism. Any point $x \in B^1 \times \mathbb{R}$ lies on a unique flow line l_x which passes through a point p_x on $B^1 \times \{0\}$. We then define $f(x) := (p_x, h(x))$, which is the identity near $\partial B^1 \times \mathbb{R}$ since the flow lines of h are standard there.

This means we can extend our smooth structure onto $B^1 \times S^1$ such that there exists a diffeomorphism $g: (B^1 \times S^1)_S \rightarrow B^1 \times S^1$ which is the identity near $\partial B^1 \times S^1$. We then proceed in a similar manner to the $k = 0$ case by normalising g such that it induces the identity on fundamental groups and then lifting to a diffeomorphism $\tilde{g}: (B^1 \times \mathbb{R})_S \rightarrow B^1 \times \mathbb{R}$. By the same argument for the $k = 0$ case, \tilde{g} must be bounded and hence we can radially reparameterise on the second factor and extend by the identity to receive a map $G: B^1 \times B^1 \rightarrow B^1 \times B^1$ which is the identity near $\partial B^1 \times B^1$ and matches g near $B^1 \times \{0\}$.

The final step is to then extend G by the identity to a diffeomorphism $\tilde{G}: B^1 \times \mathbb{R} \rightarrow B^1 \times \mathbb{R}$. Then apply the Alexander trick to $B^1 \times B^1$ to construct an isotopy \tilde{G}_t from $\tilde{G}_1 = \tilde{G}$ to $\tilde{G}_0 = \text{Id}$. Since \tilde{G} is already the identity outside of $B^1 \times B^1$ and near $\partial B^1 \times \mathbb{R}$, we may assume the isotopy fixes both of these regions. Thus, $h_t = h \circ \tilde{G}_t^{-1}$ is the desired smoothing isotopy, completing the proof.

$k = 2$ case, or 2-handle smoothing: Let $h: B^2 \rightarrow S$ be a topological embedding that is already smooth near ∂B^2 . We want to smooth this embedding completely with an isotopy that stays fixed near ∂B^2 . First, pull the smooth structure on S back onto B^2 to form B_S^2 which has the standard smooth structure near ∂B^2 . We do not have any form of torus trick available to us so we will have to construct a diffeomorphism that satisfies our requirements on our own.

Let $r: B^2 \rightarrow [0, 1]$ be the radial function on B^2 . If we consider the restriction of r to a neighbourhood of ∂B^2 we can extend this to a Morse function $\tilde{r}: B_S^2 \rightarrow [0, 1]$ since the smooth structure is standard near ∂B^2 . Since we understand the behaviour of \tilde{r} near the boundary, we know that all the critical points of \tilde{r} must lie in the interior of the disc. We can then construct Γ for B_S^2 as before. Since $\pi_1(B^2) = 0$, we know that Γ is a tree and hence we can simplify it down to a single point. This means that \tilde{r} can be simplified to have only a single critical point of index 0. We then construct a diffeomorphism $g: B_S^2 \rightarrow B^2$. Every point x in B_S^2 aside from

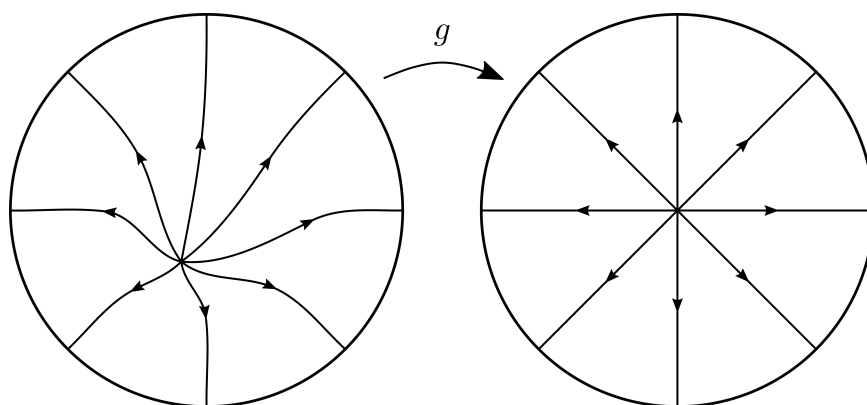

FIGURE 16.26. The diffeomorphism $g: B_S^2 \rightarrow B^2$ fixing a neighbourhood of ∂B^2 and sending flow lines for \tilde{r} to flow lines of r .

the critical point of \tilde{r} lies on a unique flow line l_{p_x} ending at a point $p_x \in \partial B^2$ and g maps x to $g(x)$ where $g(x)$ lies on the unique flow line ending at the point p_x for the radial function on B^2 such that $r(g(x)) = \tilde{r}(x)$. Finally, the critical point of \tilde{r} is mapped to $0 \in B^2$. By construction, this map must be a diffeomorphism that fixes a neighbourhood of the boundary.

Now the Alexander trick gives us an isotopy G_t of g to the identity which we may assume to be fixed near ∂B^2 , i.e. $G_0 = \text{Id}$, $G_1 = g$. Our required isotopy is then given by $h \circ G_t^{-1}$. This finishes the $k = 2$ case and hence finishes the whole proof. \square

16.2.4. Smoothing and classifying one-dimensional topological manifolds. In our proofs of Theorem 16.8 and Theorem 16.9 we used that analogous results hold for 1-manifolds. Here we give the outline of how to prove these results. It is much easier than the surfaces case and so the treatment will be less detailed (so as to not labour the point). We will discuss how to prove a 1-dimensional handle smoothing theorem, leaving it to the reader to apply it to obtain existence and uniqueness of smooth structures for topological 1-manifolds. We will use the smooth classification of 1-manifolds to do this (for a proof of this, see [Mil97a, appendix]).

0-handle smoothing: Let $h: \mathbb{R} \hookrightarrow \mathcal{O}$ be a topological embedding into a smooth 1-manifold \mathcal{O} . We can pull the smooth structure on \mathcal{O} back onto \mathbb{R} . Now consider a topological ‘immersion’ $S^1 \setminus * \hookrightarrow \mathbb{R}$, which must in fact be a topological embedding of an open interval. We can then pull the smooth structure induced by h onto this open interval to form $(S^1 \setminus *)_{\mathcal{O}}$, which by the classification of smooth 1-manifolds must be diffeomorphic to the standard interval. Hence we can extend this smooth structure onto the circle to form a smooth manifold $S_{\mathcal{O}}^1$. Again by the classification of smooth 1-manifolds, there exists a diffeomorphism $f: S_{\mathcal{O}}^1 \rightarrow S^1$. We then normalise f so that it maps $1 \in S^1$ to itself, and since f already must induce the identity homomorphism on π_1 , this means that f lifts to a map on the universal covers $\tilde{f}: \mathbb{R}_{\mathcal{O}} \rightarrow \mathbb{R}$.

It is not hard to see now, following the proof of 0-handle smoothing for surfaces, how we can construct a diffeomorphism $\tilde{F}: \mathbb{R} \rightarrow \mathbb{R}$ isotopic to the identity, such that \tilde{F} is the identity outside of D^1 and $h \circ \tilde{F}^{-1}$ is a smooth embedding.

1-handle smoothing: Let $h: I \hookrightarrow \mathcal{O}$ be a topological embedding that is smooth near ∂I . We can pull the smooth structure on \mathcal{O} back onto I , to form a smooth manifold $I_{\mathcal{O}}$ which will have the standard structure near ∂I . We can then decompose $I_{\mathcal{O}}$ as $I \cup \tilde{I} \cup I$, two standard smooth intervals glued to either end of a possibly non-standard interval. But by the classification of smooth 1-manifolds, \tilde{I} is diffeomorphic to the standard interval, and so, possibly after smoothing gluing points, we have a diffeomorphism $f: I_{\mathcal{O}} \rightarrow I$ which is the identity near the boundary. By the Alexander trick, f is topologically isotopic to the identity, and this isotopy gives the required smoothing.

Using this handle smoothing to obtain existence and uniqueness results for smooth structures on topological 1-manifolds, this allows us to now classify topological 1-manifolds. Since the smooth classification of 1-manifolds says that there are only four such manifolds: the circle, the open interval, the closed interval and the half-open interval, these must also be the only topological 1-manifolds.

16.3. Torus trick for 3-manifolds

In this section we present a version of the torus trick for 3-manifolds due to Hamilton [Ham76b]. In particular, we will describe an alternative proof of the theorem that every topological 3-manifold admits a unique PL structure up to isotopy using the torus trick. As we will see, this follows from a 3-dimensional version of the handle straightening theorem. By default, we assume that a manifold is second-countable.

16.3.1. The 3-dimensional handle straightening theorem. Recall that in lectures we discussed a CAT handle straightening theorem where CAT is PL or DIFF for manifolds of dimension 5 or higher (see Theorem 19.1 in the lecture notes). In Section 16.2 we describe a similar result for surfaces for CAT=DIFF. In this section, we prove a PL-handle straightening theorem for 3-manifolds.

We call an PL n -manifold *irreducible* if every PL $(n - 1)$ -sphere bounds a PL n -ball. The following Alexander's theorem says that \mathbb{R}^3 is irreducible.

THEOREM 16.15 (Alexander's theorem). *Every PL-embedded 2-sphere in \mathbb{R}^3 bounds a PL 3-ball.*

THEOREM 16.16. *Let $h: B^k \times \mathbb{R}^n \rightarrow \mathbb{R}^3$ be a topological embedding where $n + k = 3$ such that h is PL in a neighbourhood of the boundary $\partial(B^k \times \mathbb{R}^n)$, then there exists a (topological) isotopy h_t from h to an embedding h_1 such that*

- (1) h_1 is PL on $B^k \times B^n \subset B^k \times \mathbb{R}^n$
- (2) $h_t = h$ on $\partial(B^k \times \mathbb{R}^n)$ and $B^k \times (\mathbb{R}^n \setminus 2B^n)$ for all t .

As we shall see later, $B^k \times \mathbb{R}^n$ will be viewed as an open k -handle lies in a chart of an ambient manifold. The proof of the theorem relies on a number of lemmas, most of which are specific to 3-manifolds. First recall that a *PL-immersion* is a local PL-embedding. The next result is proved by Whitehead in 1961.

LEMMA 16.17. *Every PL n -manifold ($n \leq 3$) with no compact, unbounded components admits PL immersions in \mathbb{R}^n .*

Indeed, we will only apply Lemma 16.17 to $\mathbb{T}^n \setminus *$ for $n \leq 3$ so one can also just quote results from Section 16.1 which gives explicit smooth immersions of the n -torus for all n hence PL-immersions. The proof of Lemma 16.17 is fairly combinatorial and relies on properties of simplicial complexes, so is very different in flavour compared to the explicit immersions of the tori in Section 16.1.

A 3-manifold is *1-connected at infinity* if every compact subset is contained in another with 1-connected complement.

LEMMA 16.18. *Let M be a PL 3-manifold which is 1-connected at infinity and has compact boundary. Let K be a compact subset of the interior of M , then M contains a compact PL-submanifold A with $\partial A = \partial M \sqcup S^2 \subset M$ such that K is contained in the interior of A .*

Proof sketch. Without loss of generality we assume that $M \setminus K$ is simply-connected. Let N be a regular neighbourhood of K which is contained in finitely many simplices and $W = M \setminus \text{int}N$ connected. Label the components of $\partial N = \partial W$ by Q_1, \dots, Q_r . Each component of $N \setminus K$ contains just one Q_i , for suppose Q_1 and Q_2 are in the same component, we can join them by

two arcs, one in N and one in W , and this gives a non-trivial loop in $M \setminus K$. We label the component containing Q_i by C_i . We would like to do some modifications such that all induced maps $\alpha_i: \pi_1(Q_i) \rightarrow \pi_1(C_i)$ and $\beta_i: \pi_1(Q_i) \rightarrow \pi_1(W)$ become injective. Once we have done this, we can apply Van-kampen and conclude that all Q_i 's are simply connected hence spheres. Once we've done this, we can tubing them together and add the tubes to N to make it into one single sphere and the theorem is proved.

To do this, let g_i denotes the genus of Q_i and define non-negative integers $c_1 = \sum g_i$ and $c_2 = \sum \text{Max}(g_i - 1, 0)$. Suppose $\alpha_1(\beta_1)$ is not injective, then Dehn's lemma(see below, lemma16.23) provides an embedded disk in C_1 (respectively W) meeting Q_1 at the boundary circle which is an non-trivial element of $\pi_1(Q_1)$. Thicken D^2 up to a 3-cell meeting Q_1 at $S^1 \times I$, then we replace N by $N - D^2 \times \text{int}I$ (respectively by $N \cup D^2 \times \text{int}I$. Now $\partial N = Q'_1 \cup \dots \cup Q_r$ with $Q'_1 = Q_1 - (S^1 \times I) \cup (D^2 \times \partial I)$.

There are two cases: if S^1 is a separating curve, then c_2 decreases by 1; if S^1 is not separating, then c_1 decreases by 1. In any case, we can continue this procedure until all α_i and β_i 's are injective. □

We remark that the result clearly also holds in the smooth case.

Definition 16.19. A properly embedded connected surface S in a 3 manifold is called *incompressible* if it is not S^2 and has trivial normal bundle, and for each 2-disk D in M with $D \cap S = \partial D$, there exists a 2-disk D' in S with $\partial D = \partial D'$. The disk D is sometimes called a compressing disk.

Notice that some authors also exclude D^2 such that surgery on an incompressible surface only splits off a copy of S^2 . But we will allow D^2 for our purpose.

Definition 16.20. A PL 3-manifold M is called *sufficiently large* if it contains an incompressible surface.

A useful criteria of determining incompressible surface is the following: given a surface S other than S^2 with trivial normal bundle, if the induced map $\pi_1(S) \rightarrow \pi_1(M)$ on fundamental groups is injective, then S is incompressible. This is because every nullhomotopic circle in a surface bounds a disk. In fact, the converse is also true: suppose the induced map is not injective, let f be a null-homotopy of a non-trivial loop in S . We can deform f such that it is tranverse to S . The preimage $f^{-1}(S)$ consists of some circles which we can assume all non-trivial by redefine f if necessary. Then the restriction to the disk bounded by the inner most circle gives a null-homotopy of a non-trivial circle in S . Now Dehn's lemma(Lemma 16.23) gives a disk D in M with $D \cap S = \partial D$ and ∂D non-trivial in S . So S cannot be incompressible.

If we further require irreducibility then the manifold is called *Haken*. It is easy to see that $B^k \times \mathbb{T}^n$ is sufficiently large for $k = 0, 1, 2$ (for $k = 0, 1$, take the obvious embedded torus; for $k = 2$, take a properly embedded non-separating disk, for example, any standard disk bounded by a meridian in the solid torus).

LEMMA 16.21. *Let M and N be orientable, compact, irreducible PL 3-manifolds with N sufficiently large and let $\phi: M \rightarrow N$ be a proper PL homotopy equivalence such that $\phi|_{\partial M}$ is a PL homeomorphism, then ϕ is homotopic relative boundary to a PL homeomorphism.*

The proof of this lemma is non-trivial and involves the properties of incompressible surfaces in 3-manifolds and also properties of Haken manifolds, namely they have a hierarchy. Therefore, we will not go into the proof but just note that it can be generalised to the smooth case without much difficulty.

LEMMA 16.22 (Alexander's isotopy: PL-version). (1) If h_0 and h_1 are two PL-homeomorphisms of B^n that agree on the boundary S^{n-1} , then there exists a PL-isotopy h_t between them that fixes S^{n-1} .



FIGURE 16.27. Two possible singularities

(2) Every PL-homeomorphism of S^{n-1} extends to a PL-homeomorphism of B^n .

Proof sketch. The second statement follows directly by coning. For the first one, notice that $B^n \times [-1, 1] \cong v * (S^{n-1} \times [-1, 1] \cup B^n \times \{-1, 1\})$ where $*$ denotes the join operation. Let $H: S^{n-1} \times [-1, 1] \cup B^n \times \{-1, 1\} \rightarrow S^{n-1} \times [-1, 1] \cup B^n \times \{-1, 1\}$ by $H|_{S^{n-1} \times [-1, 1] \cup B^n \times \{-1, 1\}}$ and $H|_{B^n \times \{1\}} = h_1 h_0^{-1}$. Then apply coning. \square

As a remark, in fact, this statement do hold in the smooth case for $n = 3$ but it's non-trivial. Indeed, we have $\text{Diff}(S^n) \simeq O(n + 1) \times \text{Diff}(D^n, \partial)$ and Smale and Cerf proved that actually $\text{Diff}(D^3, \partial) \simeq \text{Diff}(S^2) \simeq O(3)$. This is called the Smale conjecture. See Hatcher's survey [Hat12].

LEMMA 16.23 (Generalised Dehn's lemma). *Let M be a connected orientable 3-manifold and $f: S \rightarrow M$ be a map from a sphere with n punctures with boundary circles (C_1, \dots, C_n) to M such that S is PL-embedded near its boundary. Then a non-vacuous subset of $T = \{C_1, \dots, C_n\}$, say (C_1, \dots, C_r) , $r \leq n$ constitute the boundary of an embedded surface S' agrees with S near T .*

Proof. (Sketch) We will only indicate a few ideas but not go into all details. First we claim without proof that under good conditions, $f(S)$ can be isotoped to be 'canonical', i.e., only have the following types of singularities: double curves and triple points. See Figure 16.27. For a proof, see lemma 3.2 of [Pap57].

For simplicity, we only show the case $n = 1$. First not that we can assume that M is compact and deformation retracts to $f(S)$. If not, take a subcomplex of M containing $f(S)$ and by subdivision if necessary and taking the union of the derived complexes containing all vertices in the boundary of $f(S)$, we can find a compact submanifold deformation retracts to $f(S)$.

Next, we show that the lemma is true if V has no 2-sheeted cover. By assumption, $H_1(V)$ is finite, otherwise we will have an induced surjective homomorphism from $\pi_1(v)$ to \mathbb{Z}_2 with an index 2 kernel. It follows from the universal coefficient theorem and Poincare duality that ∂V is a union of spheres so we are done.

Now suppose V has a 2-sheeted cover $p: V_1 \rightarrow V$ and let τ be the non-trivial deck transformation. Then $p^{-1}(C) = C_1 \cup \tau(C_1)$ where C_1 is a curve in V_1 . It turns out that if C_1 satisfies the lemma for V_1 , then C satisfies the lemma for V . To see this, let D_1 be an embedded disk in V_1 with boundary C_1 and let $D = P(D_1)$. We claim(without proof) that in this case D can be assumed to be canonical. Then since our cover is 2-sheeted, D can't have triple either so the only singularity we need to consider is double curve and one can avoid this but cutting along the double curves and analyse locally(again, details are in [Pap57]).

Now, let $d((f(S)))$ denote the number of double curves and induct on d by taking double covers repeatedly, we have the result.

The proof of the general case is similar but more complicated and involves a calculation of the Euler characteristic and we omit here.([SW58]). \square

Note that when $r = 1$ this reduces to the usual Dehn's lemma. Also, we remark that the proof works equally well in the smooth case.

Recall that a 3-manifold is called *prime* if it can not be written as a connected sum of two manifolds with neither of them is S^3 . The next result is standard:

LEMMA 16.24 (Prime decomposition theorem). *Every PL compact, orientable 3-manifold is a unique finite connected sum of prime 3-manifolds up to insertion or deletion of S^3 's.*

LEMMA 16.25. *For $(B^k \times \mathbb{T}^n)_\Sigma$ ($k = 0, 1, 2$) where Σ is some PL structure coincides with the standard structure on $B^k \times B^n$, there exists a PL structure Σ' with $\Sigma' = \Sigma$ on $B^k \times B^n$ such that $(B^k \times \mathbb{T}^n)_{\Sigma'}$ is irreducible.*

Proof. By the prime decomposition theorem, $(B^k \times \mathbb{T}^n)_\Sigma$ is a connected sum of PL irreducible manifolds. But every PL 2-sphere in $B^k \times \mathbb{T}^n$ bounds a topological 3-ball (to see this, lift to the universal cover) so all but one prime factors are topological 3-spheres. Therefore, $(B^k \times \mathbb{T}^n)_\Sigma = A \cup Q$ where Q is a topological 3-ball with $A \cap Q = \partial Q \cong S^2$. Extend the identity map of A by coning gives a homeomorphism of $B^k \times \mathbb{T}^n$ and induces a PL structure Σ' with $(B^k \times \mathbb{T}^n)_{\Sigma'}$ irreducible and $\Sigma' = \Sigma$ on A . We will show that $B^k \times B^n$ can be assumed to be contained in A .

For $k = 0$, $(\mathbb{T}^3 \setminus B^3)_\Sigma$ is 1-connected at infinity so apply Lemma 16.18 to $\mathbb{T}^3 \setminus B^3$ gives a PL 2-sphere bounding a PL 3-ball containing B^3 in \mathbb{T}^3 . Now choose the prime decomposition such that D is contained in A .

For $k = 1, 2$, the generalised Dehn's lemma provides k surfaces of type $(0, n)$ in $(B^k \times (2B^n \setminus B^n))_\Sigma$ with boundary $(\partial B^k \times \partial 1.5B^n)_\Sigma$. The union of the surface(s) and $(\partial B^k \times 1.5B^n)_\Sigma$ is a PL 2-sphere in $(B^k \times 2B^n)_\Sigma$ bounding a PL 3-ball D containing $(B^k \times B^n)_\Sigma$. Now choose a prime decomposition of $(B^k \times \mathbb{T}^n)_\Sigma \setminus D$ and reattach D to the corresponding summand, we get a desired decomposition. \square

We are now ready to prove the handle straightening theorem.

Proof of Theorem 16.16. Let $\mathbb{T}^n \setminus *$ be a punctured torus. Let $\Sigma = h^{-1}$ (standard structure on $B^k \times \mathbb{R}^n$). For $k = 3$, $h: (B^3)_\Sigma \rightarrow \mathbb{R}^3$ is PL and by coning the identity map of ∂B^3 we get a PL homeomorphism $g: (B^3)_\sigma \rightarrow B^3$ that is identity near the boundary. Here we used the fact that h is PL near ∂B^3 so $(B^3)_\Sigma$ is standard near ∂B^3 . By Lemma 16.22, we get an isotopy g_t from the identity to g . Then one checks that hg_t^{-1} is the desired ambient isotopy.

For $k = 0, 1, 2$, we constructed a torus trick diagram as follows:

- (1) Take an immersion ϕ_1 of $\mathbb{T}^n \setminus *$ in \mathbb{R}^3 . Let $\alpha: B^k \times (\mathbb{T}^n \setminus *) \rightarrow B^k \times \mathbb{R}^n$ be the product of ϕ_1 and identity. By choosing our immersion carefully, we can assume that the bottom triangle of Figure 16.28 commutes. Define $\Sigma_1 = \alpha^{-1}(\Sigma)$. By construction, Σ_1 coincides with the standard structure on $B^k \times B^n$.
- (2) Extend Σ_1 to $\partial B^k \times \mathbb{T}^n$ by letting it be the standard structure near an open collar $N(\partial B^k \times \mathbb{T}^n)$. Now $(B^k \times (\mathbb{T}^n \setminus *) \cup N(\partial B^k \times \mathbb{T}^n))_{\Sigma_1}$ is 1-connected at infinity, so by Lemma 16.18, it contains a compact PL submanifold K with boundary $(\partial B^k \times \mathbb{T}^n)_{\Sigma_1}$ and a 2-sphere S such that $B^k \times 2B^n$ is contained in its interior. By lifting to universal covers and apply the Schoenflies theorem, S bounds a topological 3-ball in $B^k \times \mathbb{T}^n$. Extend the identity map of K by coning over S gives a homeomorphism of $B^k \times \mathbb{T}^n$ which induces a PL structure Σ_2 on $B^k \times \mathbb{T}^n$. Note that since K is compact, coning must fill up all of $B^k \times \mathbb{T}^n$. By Lemma 16.25, we may assume that $(B^k \times \mathbb{T}^n)_{\Sigma_2}$ is irreducible. By applying simplicial approximation to the identity map $(B^k \times \mathbb{T}^n)_{\Sigma_2} \rightarrow B^k \times \mathbb{T}^n$ and apply Lemma 16.21, the identity map is homotopic relative to boundary to a PL homeomorphism g as in Figure 16.28.
- (3) Pull Σ_2 back to a PL structure Σ_3 on $B^k \times \mathbb{R}^n$ via the universal covering map. By arranging the inclusion $B^k \times 2B^n$ appropriately we can make sure every thing still commutes. Lift g to a PL homeomorphism \tilde{g} which is identity on the boundary. By lemma 10.5 in the lecture notes, \tilde{g} has bounded distance from identity.

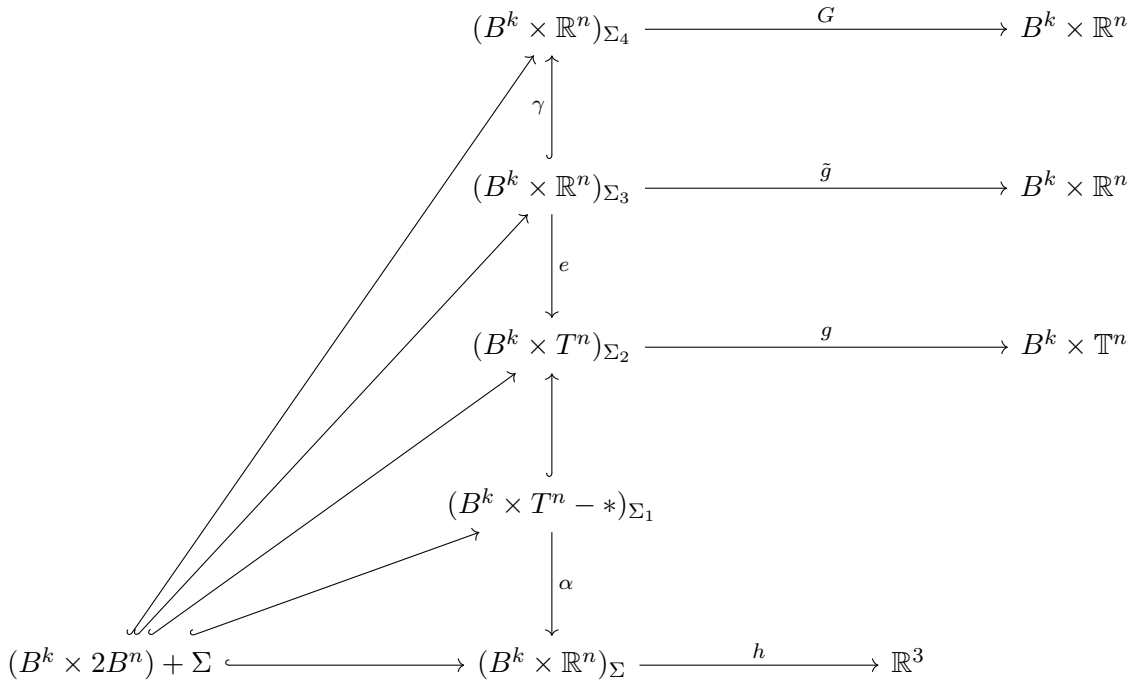

FIGURE 16.28. Torus trick diagram

- (4) Let $\gamma: B^k \times \mathbb{R}^n \rightarrow B^k \times \mathbb{R}^n$ be a PL embedding that maps onto $(B^k \times 2B^n) \setminus \{0\} \times \partial 2B^n$ and restricts to identity on $B^k \times B^n$. (This is very similar to what Hatcher did for surfaces). Let $G = \gamma \tilde{g} \gamma^{-1}$ defined on $(B^k \times 2B^n) \setminus \{0\} \times \partial 2B^n$ and extend it by identity to a homeomorphism of $B^k \times B^n$ that is identity on the boundary. (Similar to the proof of theorem 19.1 of lecture notes). Extend G further by identity gives a homeomorphism of $B^k \times \mathbb{R}^n$. Define $\Sigma_4 = G^{-1}$ (Standard structure). By construction, $\Sigma_4 = \Sigma_3$ on $B^k \times B^n$.

Now define an isotopy

$$G_t = \begin{cases} \text{Alexander isotopy from the identity to } G & \text{on } B^k \times 2B^n \\ \text{Id} & \text{Otherwise} \end{cases}$$

One checks that $hG_0^{-1} = h$, hG_1^{-1} is PL on $B^k \times B^n$ and $hG_t^{-1} = h$ on $(B^k \times \mathbb{R}^n \setminus B^k \times 2B^n) \cup \partial B^k \times \mathbb{R}^n$ (recall that \tilde{g} is identity on the boundary. Thus hG_t^{-1} is the desired isotopy. \square

Note that if we replace the simplicial approximation theorem by a version of the smooth approximation theorem and apply all the smooth versions of our lemmas, we can prove a handle smoothing theorem as we did in part 2 for surfaces.

16.3.2. Triangulation of 3-manifolds.

THEOREM 16.26. (1) Every topological 3-manifold M admits a PL-structure hence a triangulation.

- (2) If Σ_1 and Σ_2 are two PL-structures on M , there exists an ambient isotopy of M from identity to a PL-homeomorphism between M_{Σ_1} and M_{Σ_2} .

We will need a general fact from point-set topology. Recall that a topological space is called **normal** if every two disjoint closed sets have disjoint open neighborhoods. Note that topological manifolds are normal (for example, one can check this by noticing that they are metrizable).

LEMMA 16.27 (Shrinking lemma). *Let X be a normal space and $\mathcal{U} = \{U_i\}$ be a locally finite open cover, then there exists another open cover $\mathcal{W} = \{W_i\}$ such that the closure of W_i is contained in U_i for all i .*

By the classification of surfaces (instead, one can also quote the results from Section 16.2), every topological 3-manifold with boundary admits a PL structure on a collar of its boundary. Moreover, if Σ_1 and Σ_2 are two PL-structures on M , then every homeomorphism $f: M_{\Sigma_1} \rightarrow M_{\Sigma_2}$ is isotopic to one that is PL on a collar of ∂M (for example, by applying the isotopy extension theorem)

Proof of Theorem 16.26. We prove existence first. The idea is to build up a PL structure inductively by patching up the local PL structures in each chart. Let $\mathcal{U} = \{U_i\}$ be a locally finite (hence countable, since we assume that M is second countable hence Lindelöf, which gives us countability) cover. By the paragraph before this proof, the subset U_0 of boundary charts can be assumed to be PL compatible. Relabel the elements of U_0 as $\dots, U_{-2}, U_{-1}, U_0$ and the rest charts by U_1, U_2, \dots

We proceed by induction. Suppose a PL structure has been constructed on $V_r = \bigcup_{i=-\infty}^{i=r} U_i$ and let $V = U_{r+1} \cap V_r$ with the PL structure inherited from U_{r+1} . U_{r+1} intersects finitely many charts $\{U_i\}_{i \in I}$ where I is some indexing set. Apply Lemma 16.27, we can replace U_i by an open subset of U_i whose closure is contained in U_i for all $i \in I$ and get a refined cover $\mathcal{W} = \{W_i\}$. By triangulating V we get a handle decomposition of V_r . Let K be the union of all closed 3-simplices with non-empty intersection with $\bigcup_{i \in I \cap \{-\infty, \dots, r+1\}} \overline{W}_i$. Apply Theorem 16.16 to handles corresponding to K in the order of 0, 1, 2 and 3-handles, we get a homeomorphism h of V that is PL on K and identity out side a compact neighbourhood $N(K)$ of K . Then $\bigcup_{i=-\infty}^{i=r+1} W_i$ has a well-defined PL-structure inherited from V_r on $\bigcup_{i=-\infty}^{i=r} W_i$, from U_{r+1} on $V_{r+1} \setminus N(K)$, and from h on $W_{r+1} \cap V$.

For uniqueness, first isotope the identity map to a homeomorphism that is PL on some collar c of ∂M . Triangulate $M \setminus \partial M$ and subdivide such that every simplex is contained in some Σ_2 -chart of M . This gives a handle decomposition such that each handle lies in a Σ_2 -chart. Apply Theorem 16.16 to all 0-handles with non-empty intersection with $M \setminus c$ and we get an ambient isotopy that is identity on a smaller collar. Now do the same thing successively for higher dimensional handles and this gives the desired isotopy. \square

As we explained along the way, we could have done the whole proof in the smooth case: Lemma 16.21, Lemma 16.22, Lemma 16.23, Lemma 16.24 hold in the smooth category. Furthermore, Lemma 16.12 can be easily generalised to dimension 3 with a similar proof, so our proof of Theorem 16.26 can be easily modified to a smooth version. However, Lemma 16.22 is a relatively deep result in the smooth case so this approach is not necessarily an easy one. Instead, one can construct directly a smooth structure for a PL 3-manifold by defining a version of tangent space for PL manifolds called weldings. In summary, we now have an understanding of the sentence: for dimension lower or equal than 3, PL, smooth and topological categories are equivalent. Note that in dimension 4, this version of the handle straightening theorem must not be true because of the known exotic phenomena.

Remark 16.28. In dimensions ≤ 7 , every PL-structure can be upgraded to a smooth structure, and for dimension ≤ 6 this associated smooth structure is unique up to isotopy, [Mil11, Thm. 2].

Further reading

- Andrew Ranicki’s slides: ‘High dimensional manifold topology, then and now’ (2005)
- Lurie’s lecture notes on Whitehead’s theorem that smooth manifolds admit PL triangulations

Stable homeomorphisms and the annulus theorem

Danica Kosanović, Mark Powell, and Arunima Ray

We now turn our attention to the following fundamental result.

THEOREM 17.1 (Annulus Theorem (AC_n)). *If $h: D^n \hookrightarrow \text{Int } D^n \subseteq D^n$ is a locally collared embedding, then*

$$D^n \setminus h(\text{Int } D^n) \cong S^{n-1} \times [0, 1].$$

As before, by Brown’s theorem (Corollary 4.6), locally bicollared codimension one embeddings are globally bicollared, so nothing is lost by considering collared embeddings of D^n in $\text{Int } D^n$, see Fig. 17.1. Note that this is not true if we omit locally bicollared condition – a counterexample is the Alexander gored ball mentioned in Remark 4.7.

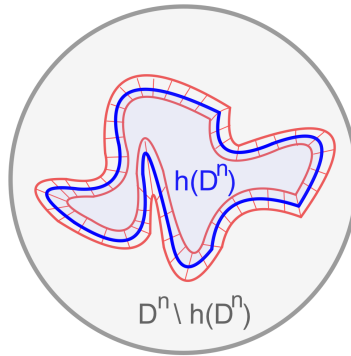

FIGURE 17.1. The Annulus Theorem asserts that $D^n \setminus h(\text{Int } D^n)$, the closed grey region in the picture, is homeomorphic to an annulus.

For the smooth and PL versions of this theorem see ???. For $n = 2, 3$ the above result follows from the classical fact that surfaces and 3-manifolds have canonical triangulations/smoothings, as shown by Radó [Rad24] and Moise [Moi52b] respectively. Kirby [Kir69] proved the case $n \geq 5$ using the torus trick, and we will explain this proof shortly. The case $n = 4$ is due to Quinn [Qui82a], and uses very different techniques.

After the Schoenflies problem, which shows that a locally bicollared codimension one sphere Σ in S^n separates S^n into two balls, the following problem is a natural extension.

Question 17.2. Let Σ, Σ' be locally bicollared disjoint codimension one spheres in S^n . By the Jordan Brouwer separation theorem (Corollary 2.9), the space $S^n \setminus (\Sigma \cup \Sigma')$ has three components, two of which are homeomorphic to an open ball by the Schoenflies theorem. Is the third region, i.e. the region “between” Σ and Σ' , homeomorphic to an annulus?

Using the Schoenflies theorem (twice), we can see that this question is indeed equivalent to the annulus problem.

Let us extend the given bicollared embedding $h: D^n \hookrightarrow \text{Int } D^n \subseteq D^n$ to a homeomorphism $h: \mathbb{R}^n \rightarrow \mathbb{R}^n$ which agrees with it on $D^n \subseteq \mathbb{R}^n$. Namely, we may include the codomain in \mathbb{R}^n

to get $h: D^n \hookrightarrow \mathbb{R}^n$, and then extend to a homeomorphism $h: \mathbb{R}^n \rightarrow \mathbb{R}^n$ using the Schoenflies theorem and the Alexander trick (Proposition 15.3.0). More specifically, the Schoenflies theorem implies that the complement of $h(D^n)$ in \mathbb{R}^n is a punctured disc, so we extend h over $\mathbb{R}^n \setminus \text{Int } D^n$, seen as the unit disc minus the center, by coning off $h|_{\partial D^n}$ and forgetting the cone points.

LEMMA 17.3. *For $h \in \text{Homeo}(\mathbb{R}^n)$ with $h(D^n) \subseteq \text{Int } D^n$ we have that $D^n \setminus h(\text{Int } D^n)$ is homeomorphic to an annulus if and only if for some $K \geq 1$ we have $KD^n \setminus h(\text{Int } D^n)$ is homeomorphic to an annulus, where KD^n is the closed disc of radius K .*

Proof. Adding $KD^n \setminus D^n$ to $D^n \setminus h(\text{Int } D^n)$ just adds a collar to the boundary of the latter manifold. The following remark shows that this cannot change its homeomorphism type. \square

Remark 17.4. Adding or subtracting a boundary collar does not change the homeomorphism type of manifolds with boundary. More precisely, if M is a manifold with boundary and

$$M' := M \cup_{\substack{m \rightarrow (m,0) \\ m \in \partial_1 M}} (\partial_1 M) \times [0, 1].$$

where $\partial_1 M \subseteq \partial M$ is a component of the boundary of M , then $M' \cong M$. This follows from the fact that manifold boundaries have collars (Theorem 4.5).

Conversely, if M' is a manifold with boundary with a collar $\phi: \partial_1 M' \times [0, 1] \hookrightarrow M'$ and $M := M' \setminus \phi(\partial_1 M' \times [0, 1])$, where $\partial_1 M' \subseteq \partial M'$ is a component of the boundary of M' , then assuming that M is a manifold with boundary we have $M' \cong M$. This can be seen similarly to the previous paragraph, since M' is the result of adding a collar to M . It is imperative that M be a manifold for this assertion to be true. For a counterexample, see the discussion of the Alexander gored ball from Remark 4.7.

Definition 17.5. Given $h \in \text{Homeo}(\mathbb{R}^n)$ we say that AC_n holds for h if $KD^n \setminus h(\text{Int } D^n)$ is an annulus for some $K > 0$.

From the preceding discussion we see that AC_n would be true if AC_n holds for each $h: \mathbb{R}^n \rightarrow \mathbb{R}^n$ satisfying $h(D^n) \subseteq \text{Int } D^n$.

Before describing our proof strategy, we discuss some situations where we may directly spot an annulus in \mathbb{R}^n . Firstly, for $0 < r < R \in \mathbb{R}$, the region $\overline{B_R(0)} \setminus B_r(0) = \{(\theta, t) \mid \theta \in [0, 2\pi), t \in [r, R]\}$ is explicitly homeomorphic to an annulus using polar coordinates, see Fig. 17.2a. By translation the same is true for concentric round spheres centred at any point in \mathbb{R}^n . Similarly, the region between any two nested round spheres as in Fig. 17.2b is an annulus. The subtlety in the annulus problem is that the ‘inner’ sphere is not necessarily round. Since topological embeddings, even bicollared ones, can be quite complicated, it is no longer obvious how to find the coordinates to see that the region between the two spheres is an annulus.

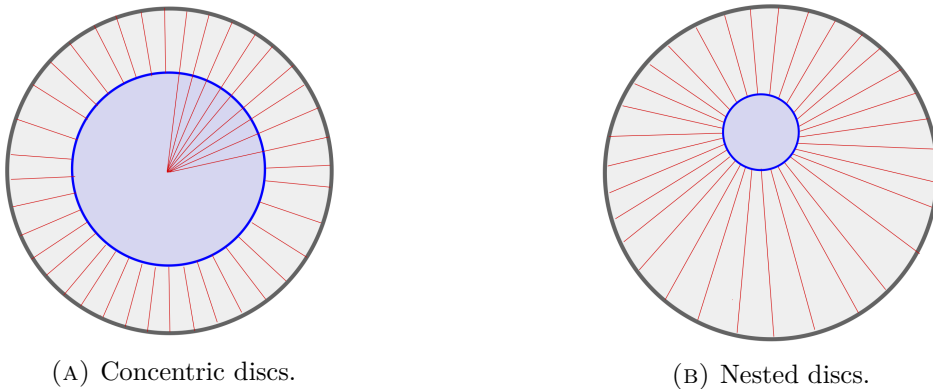

FIGURE 17.2. Examples of annuli in \mathbb{R}^n (for $n = 2$).

It is instructive to see how far the Schoenflies theorem can take us. Given a homeomorphism $h: \mathbb{R}^n \rightarrow \mathbb{R}^n$ we saw earlier that the complementary region $\mathbb{R}^n \setminus h(\text{Int } D^n)$ is a punctured disc, namely an annulus (open at one end). By truncating, we find many many closed annuli with one of the two desired boundary components. But the second boundary component is not ‘round’. Indeed our goal is to see that some $KD^n \setminus h(\text{Int } D^n)$ is an annulus, so we precisely require the second boundary component to be round.

17.1. Stable homeomorphisms

Both Kirby’s proof of AC_n for $n \geq 5$ and Quinn’s for $n = 4$ proceed via proving the stable homeomorphism theorem and then using results of Brown and Gluck, as we now explain.

Definition 17.6. A homeomorphism h of \mathbb{R}^n is *stable* if it can be written as a composition $h = h_k \circ \dots \circ h_1$ of homeomorphisms $h_i \in \text{Homeo}(\mathbb{R}^n)$ such that for all $1 \leq i \leq k$ there exists an open set $U_i \neq \emptyset$ with $h_i|_{U_i} = \text{Id}_{U_i}$.

Remark 17.7. We do not need to restrict ourselves to \mathbb{R}^n here. Given any homeomorphism $h: M \rightarrow M$ of a manifold M , we say h is stable if it can be written as a composition $h = h_k \circ \dots \circ h_1$ of homeomorphisms $h_i \in \text{Homeo}(M)$ such that for all $1 \leq i \leq k$ there exists an open set $U_i \neq \emptyset$ with $h_i|_{U_i} = \text{Id}_{U_i}$. See [BG64b, Section 4] for more details. For now we focus on the case of homeomorphisms of \mathbb{R}^n , since those are most relevant to us.

It is a standard result that any orientation preserving diffeomorphism of \mathbb{R}^n is stable, as well as any PL-homeomorphism (see Proposition 17.15). In contrast, the following is harder to prove.

THEOREM 17.8 (Stable homeomorphism theorem (SH_n)). *Every orientation preserving homeomorphism of \mathbb{R}^n is stable.*

As mentioned, this was proven by Kirby [Kir69] for $n \geq 5$, and by Quinn [Qui82a] for $n = 4$. Stable homeomorphisms were defined and systematically studied by Brown and Gluck in a sequence of papers in 1964 [BG63, BG64c, BG64b, BG64a], explicitly as a means of attacking the Annulus Theorem 17.1 (then conjecture, AC_n). In particular, they establish the following key relationship.

THEOREM 17.9. *For any $n \geq 1$ the following implications hold.*

$$(17.1) \quad SH_n \implies AC_n$$

$$(17.2) \quad \bigcup_{k \leq n} AC_k \implies SH_n$$

Proof of $SH_n \implies AC_n$. It will suffice to show that AC_n holds for every stable homeomorphism $h \in \text{Homeo}(\mathbb{R}^n)$ (we are using the reformulation of AC_n from Lemma 17.3). First we consider the case when $h|_U = \text{Id}$ for some open set U . The goal is to find $L > 0$ so that $LD^n \setminus h(\text{Int } D^n)$ is (homeomorphic to) an annulus.

We will choose L large enough so that $\text{Int}(LD^n) \supseteq h(D^n)$ and $LD^n \cap U \neq \emptyset$. In order to do this, note that $h(D^n)$ is bounded, so it is contained in some large enough round ball centred at the origin. If U is also bounded, choose L large enough so that LD^n contains both $h(D^n)$ and U . Otherwise, if U is unbounded, choose a bounded subset of U and apply the same reasoning.

Let us show that for this choice of L the space $LD^n \setminus h(\text{Int } D^n)$ is an annulus. We will use to auxiliary discs B and $h(KD^n)$, see Figure 17.3. Namely, since $\text{Int}(LD^n) \cap U$ is open we can pick $B \subseteq \text{Int}(LD^n) \cap U$ a standard round closed ball in \mathbb{R}^n . Moreover, choose $K > 0$ large enough such that $\text{Int}(h(KD^n)) \supseteq LD^n$. This is possible since LD^n is bounded and the sequence $\{h(iD^n)\}_{i \geq 1}$ is a compact exhaustion of \mathbb{R}^n .

First let us show that $h(KD^n) \setminus \text{Int } B$ is an annulus (yellow region in the first picture in Fig. 17.4a). We have $h(KD^n) \setminus \text{Int } B = h(KD^n \setminus \text{Int } B)$, since h is the identity on $U \supseteq B$ by

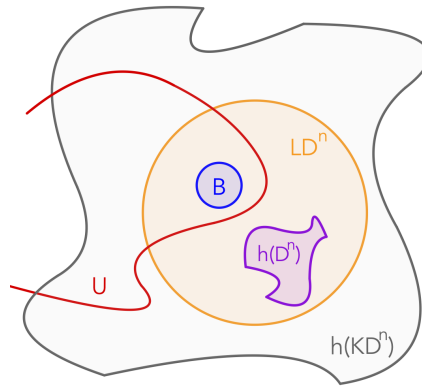

FIGURE 17.3. The setup in the proof of $SH_n \implies AC_n$ from Theorem 17.9.

hypothesis. Moreover, $KD^n \setminus \text{Int } B$ is an annulus, being the region between two nested round spheres, and h is a homeomorphism, so $h(KD^n \setminus \text{Int } B)$ is also an annulus.

Secondly, $LD^n \setminus \text{Int } B$ is also an annulus, again as the region between two nested round spheres (yellow region in the second picture in Fig. 17.4a).

From this and Remark 17.4 it follows that $h(KD^n) \setminus \text{Int}(LD^n)$ is an annulus, since it is a manifold with boundary obtained by subtracting a boundary collar, namely $LD^n \setminus \text{Int } B$, from $h(KD^n) \setminus B$ (the first row of Fig. 17.4a). That $h(KD^n) \setminus \text{Int}(LD^n)$ is a manifold with boundary follows from the fact that ∂LD^n is bicollared in $\text{Int}(h(KD^n))$.

Next, $h(KD^n) \setminus \text{Int}(h(D^n)) = h(KD^n \setminus \text{Int } D^n)$ is the homeomorphic image of an annulus, thus an annulus itself. Now another application of Remark 17.4 shows that $LD^n \setminus h(\text{Int } D^n)$ is an annulus, see Fig. 17.4b. Namely, it is the manifold with boundary obtained by subtraction of a boundary collar, namely $h(KD^n) \setminus \text{Int}(LD^n)$, from the annulus $h(KD^n) \setminus \text{Int } h(D^n)$.

We have thus shown that $LD^n \setminus h(\text{Int } D^n)$ is an annulus, proving AC_n for h . The case of a general stable homeomorphism follow immediately from the following claim. \square

CLAIM. *If AC_n holds for homeomorphisms $h, k: \mathbb{R}^n \rightarrow \mathbb{R}^n$, then it holds for $h \circ k$.*

Proof. By hypothesis, there exists $K > 0$ large enough so that $KD^n \setminus k(\text{Int } D^n)$ is an annulus. Then

$$Y := h(KD^n) \setminus h \circ k(\text{Int } D^n) = h(KD^n \setminus k(\text{Int } D^n))$$

is also an annulus since h is a homeomorphism.

Again by hypothesis, there exists $L > 0$ large enough so that $LD^n \setminus h(\text{Int } D^n)$ is an annulus. By choosing a larger L if necessary, we assume further that $\text{Int}(LD^n)$ contains $h(KD^n)$. Then we claim that

$$Z := LD^n \setminus h(\text{Int } KD^n)$$

is also an annulus by Remark 17.4. To see this, observe that

$$Z \cup \left(h(KD^n) \setminus h(\text{Int } D^n) \right) = LD^n \setminus h(\text{Int } D^n)$$

is an annulus, so Z is a manifold with boundary obtained by removing a boundary collar from an annulus. Here we used the fact that $h(KD^n \setminus \text{Int } D^n)$ is an annulus, since it is the homeomorphic image of the region between concentric round spheres, see Fig. 17.2a.

Now

$$LD^n \setminus h \circ k(\text{Int } D^n) = LD^n \setminus h(\text{Int } KD^n) \cup h(KD^n) \setminus h \circ k(\text{Int } D^n) = Z \cup Y$$

is obtained by gluing two annuli together along a common boundary component, so is also an annulus, showing that AC_n holds for $h \circ k$. \square

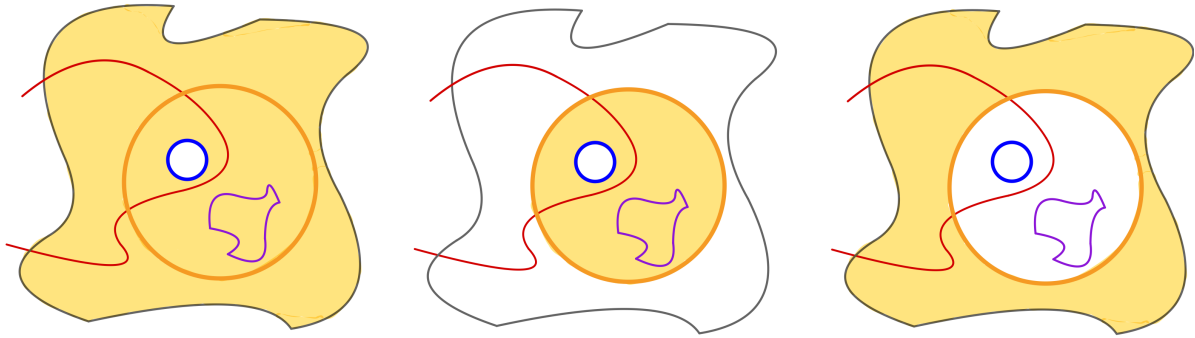

(A) As $h(KD^n) \setminus \text{Int } B$ and $LD^n \setminus \text{Int } B$ are annuli, their difference $h(KD^n) \setminus \text{Int}(LD^n)$ is as well.

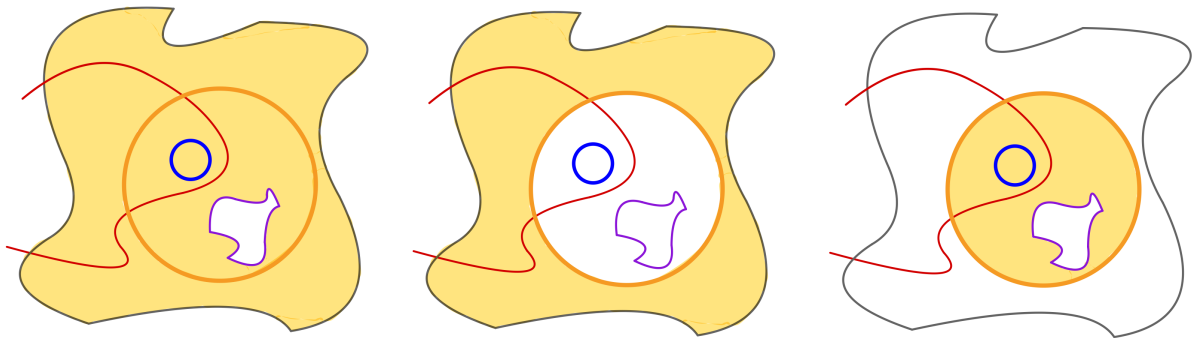

(B) As $h(KD^n) \setminus h(\text{Int } D^n)$ and $h(KD^n) \setminus \text{Int}(LD^n)$ are annuli, their difference $LD^n \setminus h(\text{Int } D^n)$ is as well.

FIGURE 17.4. Arguments in the proof of $SH_n \implies AC_n$.

17.1.1. Properties of stable homeomorphisms. Before giving Kirby’s proof of SH_n for $n \geq 5$ we gather together the relevant facts about stable homeomorphisms, starting with the following pleasant property of stable homeomorphisms.

PROPOSITION 17.10. *Every stable $h \in \text{Homeo}(\mathbb{R}^n)$ is isotopic to Id.*

Proof. Write $h = h_k \circ \dots \circ h_1: \mathbb{R}^n \rightarrow \mathbb{R}^n$ as in the definition. Since each h_i agrees with $\text{Id}_{\mathbb{R}^n}$ on some open set, it is isotopic to it by Proposition (15.3.v). Therefore, the composite map $h = h_k \circ \dots \circ h_1$ is isotopic to $\text{Id}_{\mathbb{R}^n}$ as well. \square

We now show that stability is a ‘local’ property of homeomorphisms, namely, that if a homeomorphism agrees with a stable homeomorphism on an open set, it must itself be stable.

LEMMA 17.11. *Let $h, k \in \text{Homeo}(\mathbb{R}^n)$ be such that there exists a nonempty open set U with $h|_U = k|_U$. Then h and k are either both stable or both unstable.*

Proof. We can write $k = h \circ (h^{-1} \circ k)$, where $(h^{-1} \circ k)|_U = \text{Id}$, so $h^{-1} \circ k$ is stable. Then h stable implies that k is stable, since the composition of stable maps is stable. A similar argument shows that k stable implies h stable. \square

Since stability is a ‘local’ property, the following is a natural notion of stability for maps between subsets of \mathbb{R}^n .

Definition 17.12. Let $U, V \subseteq \mathbb{R}^n$ be open. A homeomorphism $h: U \rightarrow V$ is *stable* if every $x \in U$ has a neighbourhood $W_x \subseteq U$ such that $h|_{W_x}$ extends to a stable homeomorphism of \mathbb{R}^n .

In particular, the restriction of a stable homeomorphism of \mathbb{R}^n is stable in the above sense. Since we will use the torus trick in the upcoming proof of SH_n the following result is reassuring.

PROPOSITION 17.13 ([Con63, Lem. 5, p. 335]). *If $h \in \text{Homeo}(\mathbb{R}^n)$ is bounded distance from the identity, then h is stable.*

We begin with a helpful lemma.

LEMMA 17.14. *Translations of \mathbb{R}^n are stable.*

Proof. Consider a translation $t: \mathbb{R}^n \rightarrow \mathbb{R}^n$ and a strip $S_1 := \mathbb{R} \times [-1, 1]^{n-1}$ aligned with the direction of the translation, and another strip $S_2 := \mathbb{R} \times [-2, 2]^{n-1}$ containing it. Construct two homeomorphisms, the first that fixes S_1 and moves $\mathbb{R}^n \setminus S_2$ by the translation. The second homeomorphism fixes $\mathbb{R}^n \setminus S_2$ and applies the translation to S_1 . In the difference $S_2 \setminus S_1$, we interpolate, so that the composition of the two homeomorphisms is the given translation. \square

Proof of Proposition 17.13. By Lemma 17.14, since compositions of stable maps are stable, we may assume, without loss of generality, that $h(0) = 0$. Let $\rho: [0, \infty) \rightarrow [0, 2)$ be a homeomorphism with $\rho|_{[0,1]} = \text{Id}$. Then we define the homeomorphism

$$\begin{aligned} \gamma: \mathbb{R}^n &\xrightarrow{\cong} \text{Int}(2D^n) \\ \vec{x} &\mapsto \rho(|\vec{x}|) \frac{\vec{x}}{|\vec{x}|} \end{aligned}$$

Observe that by construction, $\gamma|_{D^n} = \text{Id}$. Next we define a homeomorphism

$$\begin{aligned} H: \mathbb{R}^n &\xrightarrow{\cong} \mathbb{R}^n \\ x &\mapsto \begin{cases} \gamma h \gamma^{-1}(x) & x \in \text{Int } 2D^n \\ x & x \in \mathbb{R}^n \setminus \text{Int } 2D^n. \end{cases} \end{aligned}$$

We leave it to the reader to verify that H is continuous and a homeomorphism. The continuity uses that h is bounded distance from the identity.

We assert that h and H agree in a neighbourhood of 0. Specifically, h and H agree on the nonempty open set $U := h^{-1}(\text{Int } D^n) \cap \text{Int } D^n$, as we now show. First we know that $0 \in U$ since $h(0) = 0$, so $U \neq \emptyset$. Let $x \in U$. Then $\gamma^{-1}(x) = x$ since $\gamma|_{D^n} = \text{Id}$. Next we know that $h\gamma^{-1}(x) = h(x) \in \text{Int } D^n$ since $U \subseteq h^{-1}(\text{Int } D^n)$. Finally we use again that $\gamma|_{D^n} = \text{Id}$ to see that $H(x) := \gamma h \gamma^{-1}(x) = \gamma h(x) = h(x)$.

By definition, we have that $H|_{\mathbb{R}^n \setminus 2D^n} = \text{Id}$, so H is stable. Then by Lemma 17.11, the homeomorphism h must also be stable. \square

17.2. Stable homeomorphism in the smooth and PL categories

Recall that our present goal is to prove that every homeomorphism of \mathbb{R}^n is stable. The next proposition shows this is only interesting in the topological category.

PROPOSITION 17.15. *Every orientation preserving diffeomorphism of \mathbb{R}^n is stable. Every orientation preserving PL homeomorphism is stable.*

We will use the *smooth isotopy extension theorem*, see e.g. [Hir94, Chap. 8] or [Lee13b].

THEOREM 17.16 ((Smooth) isotopy extension theorem). *Let $U \subseteq M$ be an open subset of a smooth manifold, and let $A \subseteq U$ compact. Let $F: U \times [0, 1] \rightarrow M$ be a smooth isotopy such that the track of the isotopy*

$$\begin{aligned} \widehat{F}: U \times [0, 1] &\rightarrow M \times [0, 1] \\ (x, t) &\mapsto (F(x, t), t) \end{aligned}$$

has open image. Then there is an isotopy $H: M \times [0, 1] \xrightarrow{\widehat{H}} M \times [0, 1] \xrightarrow{proj} M$ with H_t a diffeomorphism for all t , H has compact support (i.e. $H_t = \text{Id}$ outside some compact set for each t) and there exists a neighbourhood $V \supseteq A \times [0, 1]$ such that $\widehat{H}|_V = \widehat{F}|_V$.

Sketch proof. Use tangent vectors to the curves $\widehat{F}(x \times [0, 1]) \subseteq M \times [0, 1]$ to get a vector field on $\widehat{F}(U \times [0, 1])$. Extend the latter to all of $M \times [0, 1]$, with compact support, and then integrate. \square

There is also a PL isotopy extension theorem (see, e.g. [RS82]).

Proof of Proposition 17.15. First we address the smooth case. Recalling that translations are stable (Lemma 17.14), it suffices to consider $h: \mathbb{R}^n \rightarrow \mathbb{R}^n$ a diffeomorphism with $h(0) = 0$. Define a smooth isotopy

$$\begin{cases} \frac{1}{t}h(tx) & 0 < t \leq 1 \\ dh|_{x=0} & t = 0 \end{cases}$$

from h to a linear map. Recall that $\text{GL}_n(\mathbb{R})$ has two path components detected by $\det > 0$ (if orientation preserving) or $\det < 0$ (if orientation reversing). Choose a smooth path in $\text{GL}_n(\mathbb{R})$ from the linear map to Id . Putting the last two steps together, we have produced a smooth isotopy $H: \mathbb{R}^n \times [0, 1] \rightarrow \mathbb{R}^n$, satisfying $H_0 = \text{Id}$ and $H_1 = h$, where H_t diffeomorphism for all t .

Let $U \ni 0$ be open. Apply the smooth isotopy extension theorem to $H|_{U \times [0, 1]}$ to get \widehat{H} . Here $H|_{U \times [0, 1]}$ has open image since it is the restriction of an ambient isotopy,

$$\begin{array}{ccc} \mathbb{R}^n \times [0, 1] & & \\ \text{incl.} \uparrow & \searrow H & \\ U \times [0, 1] & \xrightarrow{H|_{U \times [0, 1]}} & \mathbb{R}^n \\ \downarrow \text{incl.} & \nearrow \widehat{H} & \\ \mathbb{R}^n \times [0, 1] & & \end{array}$$

In the above diagram, the top triangle commutes, and there exists a neighbourhood V of $0 \times [0, 1]$, such that the bottom triangle commutes on V , i.e. $\widehat{H}|_V = (H|_{U \times [0, 1]})|_V = H|_V$. Since the isotopy extension theorem provides an isotopy with compact support, we know in particular that \widehat{H}_1 restricts to the identity outside some compact set.

Since \widehat{H}_1 agrees with Id on some nonempty open set, we see that \widehat{H}_1 is stable by definition. Moreover, $h = H_1$ agrees with \widehat{H}_1 on $proj(V)$, so h is also stable by Lemma 17.11. This completes the proof of the first statement.

For the *PL* statement, we will use a similar argument. First we know that every orientation preserving *PL* embedding of D^n in \mathbb{R}^n is isotopic to the identity [RS82]. The *PL* isotopy extension theorem then shows that a germ near 0 can be extended to a homeomorphism which is the identity outside some compact set, as in the previous argument. \square

We need a definition of stability for *PL* homeomorphisms.

Definition 17.17. A homeomorphism $h: M \rightarrow N$ between oriented, *PL* manifolds is *stable* at $x \in \text{Int } M$ if there are *PL* coordinate charts $\phi: \Delta^n \rightarrow M$, with $x \in \phi(\overset{\circ}{\Delta}^n)$ and $\psi: \Delta^n \rightarrow N$, with $h(x) \in \psi(\overset{\circ}{\Delta}^n)$, with $h(\phi(\overset{\circ}{\Delta}^n)) \cap \psi(\overset{\circ}{\Delta}^n) \neq \emptyset$ such that the composition

$$\psi^{-1}h\phi|: \phi^{-1}h^{-1}\psi(\Delta^n) \rightarrow \mathbb{R}^n$$

extends to a stable homeomorphism of \mathbb{R}^n .

Observe that h is only assumed to be a homeomorphism in the above definition. We know already from Proposition 17.15 that orientation preserving *PL* homeomorphisms are stable.

Similar to above, we may define a notion of stability for diffeomorphisms of connected, oriented, smooth manifolds, but we omit this, since we will not need it.

Remark 17.18. We have restricted ourselves to defining stability of PL homeomorphisms. However, we may also define a notion of stable manifolds. Similar to how PL and smooth manifolds are defined by describing the allowed transition maps, a stable manifold is one where the transition maps are stable, in the sense of Definition 17.12. See [BG63, BG64c, BG64b, BG64a] for further details. In particular, every orientable smooth or PL manifold admits a stable structure [BG64b, Theorem 10.4]. The above definition indicates the correct notion of stability for a homeomorphism of a manifold with a stable structure.

Next we show that whether a given homeomorphism is stable is a local property, namely we need only check for stability at a single (arbitrary) point. For this we first need a lemma.

LEMMA 17.19. *Let M be a connected PL manifold. For any given pair $x, y \in \text{Int } M$ there exists a PL coordinate chart with image containing both x and y .*

More precisely, for $x, y \in \text{Int } M$ and a PL coordinate chart $\phi: \Delta^n \rightarrow M$ giving a neighbourhood of x , there exists an orientation preserving PL homeomorphism $f: M \rightarrow M$ such that $f^{-1}\phi$ is a PL coordinate chart giving a neighbourhood of both x and y .

Proof. Let $\phi: \Delta^n \rightarrow M$ be a PL coordinate chart with $x \in \phi(\overset{\circ}{\Delta}^n)$. Choose $b \in \phi(\overset{\circ}{\Delta}^n)$ with $b \neq x$. Choose an open set $W \ni x, y$ with $x \notin W$.

There exists an orientation preserving PL homeomorphism $f: M \rightarrow M$ with $y \mapsto b$ and $f|_{M \setminus W} = \text{Id}$. Since $x \notin W$, we know that $f(x) = x$. Then $f^{-1}(\phi(\overset{\circ}{\Delta}^n)) \ni y, x$ and $f^{-1} \circ \phi: \Delta^n \rightarrow M$ is a PL coordinate chart with $x, y \in f^{-1} \circ \phi(\overset{\circ}{\Delta}^n)$, as claimed. \square

PROPOSITION 17.20 ([BG64b, Theorem 7.1]). *Let M and N be connected, oriented, PL manifolds. A homeomorphism $h: M \rightarrow N$ is stable at some $x \in \text{Int } M$ if and only if it is stable at every $x \in \text{Int } M$.*

Proof. Assume that h is stable at $x \in \text{Int } M$ with respect to PL coordinate charts ϕ at x and ψ at $h(x)$. In other words, the composition

$$\psi^{-1}h\phi: \phi^{-1}h^{-1}\psi(\overset{\circ}{\Delta}^n) \rightarrow \mathbb{R}^n$$

extends to a PL homeomorphism of \mathbb{R}^n . Choose $y \in \text{Int } M$ with $y \neq x$. We will show that h is stable at y , which will complete the proof.

We claim that h is stable at x with respect to $f^{-1}\phi$ and ψ at $h(x)$, for f as in the lemma. To see this, we must consider the composition $\psi^{-1}hf^{-1}\phi = \psi^{-1}h\phi \circ \phi^{-1}f\phi$, when both functions are defined. Here we know by hypothesis that $\psi^{-1}h\phi$ is stable, and also that $\phi^{-1}f\phi$ is since f is an orientation preserving PL homeomorphism. The composition of stable homeomorphisms is stable, and therefore, h is stable at x with respect to $f^{-1}\phi$ and ψ at $h(x)$.

But then h is stable at every point in $f^{-1}\phi(\overset{\circ}{\Delta}^n)$, and so h is also stable at $y \in M$. \square

Lest the reader be concerned that we have two distinct notions of stability for a homeomorphism, the following proposition should lay the mind at ease.

PROPOSITION 17.21 ([BG64b, Theorem 13.1]). *For homeomorphisms of \mathbb{R}^n , Definition 17.6 and Definition 17.17 agree. For the second definition, we fix some PL structure on \mathbb{R}^n . In particular, the statement shows that the choice is irrelevant, assuming one exists.*

Indeed, the two definitions agree in general (see Remark 17.7), assuming a PL structure exists on the given manifold. This shows that for a given manifold M , a given homeomorphism is stable regardless of the PL structure on M . However, we must still choose the same PL structure on both domain and codomain (in this case, both are M). Specifically, given two distinct PL structures Σ and Σ' on a manifold M , denoting the corresponding PL manifolds as M_Σ and $M_{\Sigma'}$ respectively, even the identity map $\text{Id}: M_\Sigma \rightarrow M_{\Sigma'}$ need not be stable.

Proof of Proposition 17.21. It is clear that Definition 17.6 implies Definition 17.17 by the definition of a PL structure.

Suppose a homeomorphism $h: \mathbb{R}^n \rightarrow \mathbb{R}^n$ is stable under Definition 17.17 at some $x \in \mathbb{R}^n$ with respect to some PL structure on \mathbb{R}^n . Let $\phi: \Delta^n \rightarrow \mathbb{R}^n$ be a PL coordinate chart with $x, h(x) \in \phi(\Delta^n)$. Such a chart exists by Lemma 17.19. By hypothesis, $\phi^{-1}h\phi$ is stable at $\phi^{-1}(x) \in \mathbb{R}^n$. It is shown in [BG64b] that $\phi^{-1}h\phi|$ restricted to some neighbourhood of $\phi^{-1}(x)$ extends to a homeomorphism h' of \mathbb{R}^n such that $h'|_{\partial\Delta^n} = \text{Id}$. Then $\phi h' \phi^{-1}: \phi(\Delta^n) \xrightarrow{\cong} \phi(\Delta^n)$ agrees with h on a neighbourhood of x , since on such a neighbourhood, $h' = \phi^{-1}h\phi$ and so $\phi h' \phi^{-1} = \phi \phi^{-1} h \phi \phi^{-1} = h$. Moreover, on $\phi(\partial\Delta^n)$, we have that $\phi h' \phi^{-1} = \phi \phi^{-1} = \text{Id}$. Extend by the identity to get a homeomorphism $h_1: \mathbb{R}^n \rightarrow \mathbb{R}^n$.

Then observe that h_1 agrees with the identity on an open set and thus h_1 is stable in the sense of Definition 17.6. We also know that h_1 agrees with h on a neighbourhood of x , and so h_1 is stable in the sense of Definition 17.6 by Lemma 17.11. \square

We need one final property of stable homeomorphisms for use in the proof of the stable homeomorphism theorem.

PROPOSITION 17.22. *Let $M, N, \widetilde{M}, \widetilde{N}$ be connected oriented PL manifolds. If in a commutative diagram*

$$\begin{array}{ccc} \widetilde{M} & \xrightarrow[\cong]{\widetilde{f}} & \widetilde{N} \\ \alpha \downarrow & & \downarrow \beta \\ M & \xrightarrow[\cong]{f} & N \end{array}$$

the vertical arrows α and β are local PL homeomorphisms, then the homeomorphism \widetilde{f} is stable if and only if the homeomorphism f is stable.

Note that codimension zero PL immersions and PL covering maps are local PL homeomorphisms.

Proof. Suppose that \widetilde{f} is stable. Let ϕ and ψ be coordinate charts for \widetilde{M} and \widetilde{N} respectively, so that the composition $\psi^{-1} \circ \widetilde{f} \circ \phi|$ extends to a stable homeomorphism of \mathbb{R}^n . Observe that suitable small restrictions of $\alpha\phi$ and $\beta\psi$ are PL coordinate charts for M and N respectively. Then a suitably small restriction of $\psi^{-1}\beta^{-1}f\alpha\phi$ extends to a stable homeomorphism of \mathbb{R}^n , since $\psi^{-1}\beta^{-1}f\alpha\phi$ agrees with $\psi^{-1} \circ \widetilde{f} \circ \phi|$ on a small enough neighbourhood. In light of Proposition 17.20, this finishes the proof of one direction. The other direction is similar. \square

17.3. Proof of the stable homeomorphism theorem

We now have the ingredients to prove the stable homeomorphism theorem for $n \geq 5$, that every orientation preserving homeomorphism of \mathbb{R}^n is stable [Kir69].

Proof. We begin with an orientation preserving homeomorphism $f: \mathbb{R}^n \rightarrow \mathbb{R}^n$. As before, the proof consists of building from the bottom up the maps in the following diagram, where all manifolds are endowed with PL structures – those without subscripts have their standard PL structure, while nonstandard PL structures are denoted by subscripts and will be defined shortly.

We begin with a PL immersion $\alpha: T^n \setminus x \rightarrow \mathbb{R}^n$ for some $x \in T^n$, as provided by Corollary 15.6. Here we are using the fact that a smooth map induces a PL map as described in Chapter 13.

Since f is a homeomorphism, the composition $f \circ \alpha$ is a topological immersion.

$$(17.3) \quad \begin{array}{ccc} \mathbb{R}^n & \xrightarrow{\tilde{h}} & \mathbb{R}^n \\ \downarrow e & & \downarrow e \\ T^n & \xrightarrow[\cong]{\bar{h}} \tilde{T}_\Sigma^n & \xrightarrow[\cong_{PL}]{g^{-1}} T^n \\ \downarrow & & \downarrow \\ T^n & \xrightarrow[\cong]{\hat{h}} T_\Sigma^n & \\ \uparrow & & \uparrow \\ T^n \setminus \mathring{B} & \xrightarrow{h|} (T^n \setminus \mathring{B})_\Sigma & \\ \uparrow & & \uparrow \\ T^n \setminus A & \xrightarrow{h|} (T^n \setminus A)_\Sigma & \\ \downarrow & & \downarrow \\ T^n \setminus x & \xrightarrow{h} (T^n \setminus x)_\Sigma & \\ \downarrow \alpha & & \downarrow f\alpha \\ \mathbb{R}^n & \xrightarrow[\cong]{f} & \mathbb{R}^n \end{array}$$

Let $(T^n \setminus x)_\Sigma$ denote the topological manifold $T^n \setminus x$ endowed with a PL structure Σ induced by the immersion $f \circ \alpha$. In other words, with respect to this induced PL structure, the map $f \circ \alpha: (T^n \setminus x)_\Sigma \hookrightarrow \mathbb{R}^n$ is a PL immersion. The map h completes the square. On the level of topological manifolds h is the identity map. We use a different symbol here in an attempt to avoid confusion – Since Σ is not equivalent to the standard PL structure on $T^n \setminus x$, the map h is not *a priori* a stable map. Observe that by Proposition 17.22 the map h is stable if and only if f is stable.

Let A be an open ball around $x \in T^n$. Then $A \setminus x$ is an open submanifold of $(T^n \setminus x)_\Sigma$ and therefore inherits a PL structure; we denote the corresponding manifold by $(A \setminus x)_\Sigma$. Observe that $A \setminus x$ is homeomorphic to $S^{n-1} \times \mathbb{R}$. By Theorem 13.5, we know that $(A \setminus x)_\Sigma$ is PL homeomorphic to $S^{n-1} \times \mathbb{R}$, the latter with its standard PL structure. Choose one of those radial copies of S^{n-1} in $(A \setminus x)_\Sigma$ and call it S . This sphere S is bicollared in T^n and therefore by the Schoenflies theorem on the n -torus (Proposition 15.7), since $n \geq 3$, bounds a closed ball B in T^n . The sphere $S = \partial B \subseteq (T^n \setminus x)_\Sigma$ carries the standard PL structure on S^{n-1} and therefore we can glue together $(T^n \setminus \mathring{B})_\Sigma$ and D^n carrying its standard PL structure (inducing the standard PL structure on its boundary, to produce a PL structure on T^n . We still call this Σ . The torus T^n endowed with this PL structure, that is the PL manifold T_Σ^n occurs in the second and third line of the diagram. Here we used the Alexander trick (Proposition 15.3) to extend the map $h|: T^n \setminus \mathring{B} \rightarrow (T^n \setminus \mathring{B})_\Sigma$ to a homeomorphism $\hat{h}: T^n \rightarrow T_\Sigma^n$. In particular, while the map h was only the identity map under an alias, the map \hat{h} may not be the identity everywhere (of course it agrees with h on $T^n \setminus \mathring{B}$).

Next we need another tool from PL topology. Specifically, we know from Theorem 13.6 that we can lift both T^n and T_Σ^n along finite-sheeted PL covering maps so that the induced map $\bar{h}: T^n \rightarrow \tilde{T}_\Sigma^n$ is homotopic to a PL homeomorphism $g: T^n \rightarrow \tilde{T}_\Sigma^n$. Here we have used the fact that every finite sheeted cover of T^n is also T^n . The inverse of the PL homeomorphism g appears in the second line of the diagram.

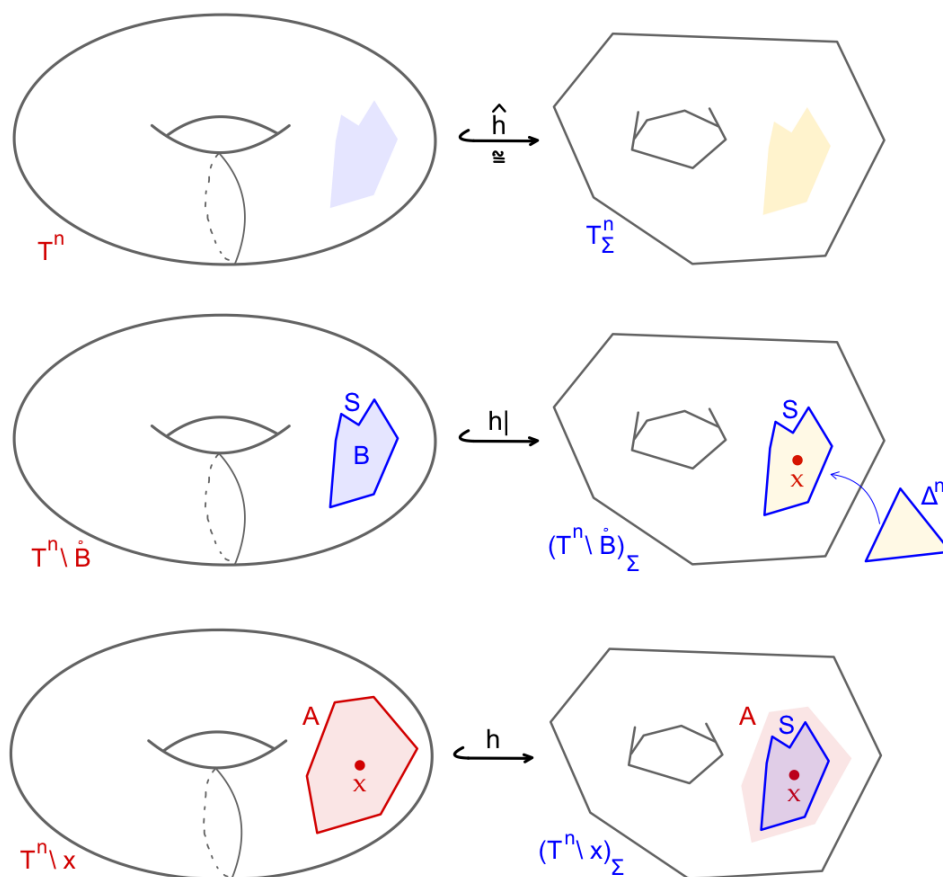

FIGURE 17.5. The proof of the stable homeomorphism theorem.

Since \bar{h} and g are homotopic, we know that $g^{-1} \circ \bar{h}$ is homotopic to the identity. By Lemma 15.5 the map $\tilde{h}: \mathbb{R}^n \rightarrow \mathbb{R}^n$, induced by the universal covering map $e: \mathbb{R}^n \rightarrow T^n$, is bounded distance from Id . Then by Proposition 17.13 it follows that \tilde{h} is stable.

Having reached the top of the diagram, now we climb back down. Since \tilde{h} is stable, we know that $g^{-1} \circ \bar{h}$ is stable by Proposition 17.22. Next, we know that the map g is a PL homeomorphism, which we may further assume to be orientation preserving by \cdot . The composition of stable maps is stable so $\bar{h} = g \circ (g^{-1} \circ \bar{h})$ is stable. Then \hat{h} is stable by Proposition 17.22. A restriction of a stable map is stable, so h is stable, and then finally f is stable. This completes the proof. \square

Remark 17.23. In Kirby’s paper proving the stable homeomorphism theorem [Kir69], he initially only reduced it to the Hauptvermutung for tori, that is to a conjecture regarding the number of PL structures on the n -torus. The key insight that one could pass to finite sheeted covers is credited to Siebenmann. Indeed, as we will soon see there do exist nonstandard PL structures on the n -torus for $n \geq 5$, so the step cannot be bypassed. Therefore perhaps Siebenmann deserves some nontrivial credit for the result.

Remark 17.24. Why can we not use the proof above in dimension four? For one thing, the input from PL manifold theory depended on the powerful machinery of surgery theory, which does not work in dimension four. However, as mentioned before, AC_n as well as SH_n is indeed true in dimension four, as proved by Quinn [Qui82a].

Remark 17.25. Why do we need to resort to PL technology in the above proof? Is it possible to use just smooth technology? The key difference between the smooth and PL categories that we exploit in the proof is that the PL Poincaré conjecture is true in all dimensions (recall this was

used in the proofs of the results of Wall [Wal67] and Browder [Bro65]), but in many dimensions is known to be false in the smooth category.

17.4. Consequences of SH_n and AC_n

We present a couple of important consequences of these theorems, namely that orientation preserving homeomorphisms of both \mathbb{R}^n and S^n are isotopic to the identity, for $n \geq 5$, and that for dimension at least six, connected sum of manifolds is well-defined in the same sense as this holds in the PL and smooth categories.

THEOREM 17.26. *For $n \geq 5$ every orientation preserving homeomorphism of \mathbb{R}^n is isotopic to the identity.*

Proof. Every orientation preserving homeomorphism is stable and stable homeomorphisms are isotopic to the identity. Use the Alexander trick for each homeomorphism in the composite, each of which is the identity on an open subset. \square

THEOREM 17.27. *For $n \geq 5$ every orientation preserving homeomorphism of S^n is isotopic to the identity.*

Proof. Consider an orientation preserving homeomorphism $f: \mathbb{R}^n \cup \{\infty\} = S^n \xrightarrow{\cong} S^n = \mathbb{R}^n \cup \{\infty\}$. Isotope f so that $f(\infty) = \infty$ (for example, via a rotation). The restriction $f|_{\mathbb{R}^n}$ is an orientation preserving homeomorphism, so $f|_{\mathbb{R}^n}$ is stable and thus $f: S^n \rightarrow S^n$ is stable. So $f = f_1 \circ \dots \circ f_k$ with $f_i|_{U_i} = \text{Id}$, where $U_i \subseteq S^n$ open. Now use Alexander trick to isotope f_i to Id and conclude that f isotopic to Id . \square

Remark 17.28. There exist orientation preserving diffeomorphisms of S^n that are not smoothly isotopic to the identity. For example, Milnor's exotic spheres can be built by gluing together two copies of D^7 along an orientation preserving diffeomorphism of S^6 . It is an open question whether every orientation preserving diffeomorphism of S^4 is smoothly isotopic to the identity.

THEOREM 17.29. *Let $n \geq 6$.*

- (1) *Connected sum of a pair of oriented, connected topological n -manifolds is well-defined.*
- (2) *Connected sum of connected topological n -manifolds is well-defined provided at least one of the two manifolds is nonorientable.*

Example 17.30. The choices of orientation are important, since $\mathbb{C}\mathbb{P}^{2n} \# \mathbb{C}\mathbb{P}^{2n}$ and $\mathbb{C}\mathbb{P}^{2n} \# \overline{\mathbb{C}\mathbb{P}^{2n}}$ are not even homotopy equivalent.

We restrict to $n \geq 6$ in Theorem 17.29 because we will use Theorem 17.27 for S^{n-1} in the proof. In fact Theorem 17.27 holds for all n , but since we are focusing on the high dimensional development here, we only state and prove the theorem in dimension at least six.

To make sense of Theorem 17.29, we need to define connected sum. Since the most subtleties occur in the oriented case, we work in that case from now on.

Definition 17.31. Let M_1 and M_2 be connected, oriented n -manifolds. Let $\phi: D^n \rightarrow M_1$ be an orientation preserving locally collared embedding, and let $\psi: D^n \rightarrow M_2$ be an orientation reversing locally collared embedding. Then we define

$$M_1 \# M_2 := \frac{M_1 \setminus \text{Int } \phi(D^n) \sqcup M_2 \setminus \text{Int } \psi(D^n)}{\phi(\theta) \sim \psi(\theta), \theta \in S^{n-1}}.$$

So the content of Theorem 17.29 is the following proposition.

PROPOSITION 17.32. *For $n \geq 6$ the manifold $M_1 \# M_2$ is independent of the choice of ϕ and ψ .*

Proof. It suffices to prove that the connected sum is independent of the choice of ϕ . So let $\phi' : D^n \rightarrow M_1$ be another orientation preserving locally collared embedding. We aim first to construct a homeomorphism $h : M_1 \rightarrow M_1$ such that $h \circ \phi'$ and ϕ have the same image.

Step 1: There is an orientation preserving homeomorphism $h_1 : M_1 \rightarrow M_1$ sending $\phi'(0)$ to $\phi(0)$. Namely, manifolds are homogeneous: for any two points in the interior of a manifold, there is an orientation preserving homeomorphism sending one point to the other. See exercise.

Step 2: There is an orientation preserving homeomorphism $h_2 : M_1 \rightarrow M_1$ such that

$$h_2 \circ h_1(\phi'(D^n)) \subseteq \text{Int } \phi(D^n).$$

To see this, use that $h_1\phi'(D^n)$ is locally collared, hence globally collared since the boundary is codimension one. Then one can stretch the collar out while radially shrinking $h_1\phi'(D^n)$ until it lies within the desired interior, see Fig. 17.6.

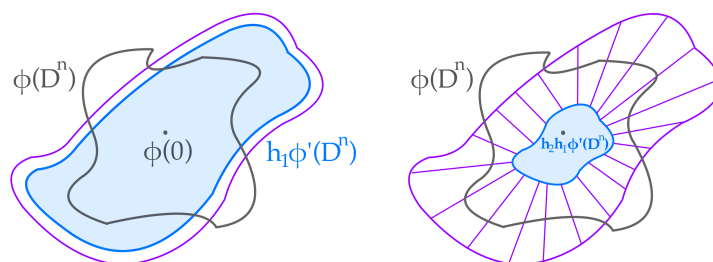

FIGURE 17.6. Step 2 of the proof: shrink $h_1\phi'(D^n)$ into $\text{Int } \phi(D^n)$.

Step 3: There is an orientation preserving homeomorphism $h_3 : M_1 \rightarrow M_1$ such that

$$h_3 \circ h_2 \circ h_1(\phi'(D^n)) = \phi(D^n).$$

To see this we apply the Annulus Theorem 17.1. The region $\phi(D^n) \setminus \text{Int}(h_2 \circ h_1 \circ \phi'(D^n))$ is homeomorphic to $S^{n-1} \times [0, 1]$, and a choice of such a homeomorphism may be used, together with the outside collar on $\phi(D^n)$, to stretch out $h_2 \circ h_1 \circ \phi'(D^n)$ until it covers all of $\phi(D^n)$.

We write $h = h_3 \circ h_2 \circ h_1$ and

$$\phi'' := h_3 \circ h_2 \circ h_1 \circ \phi'.$$

Our aim is now to show that ϕ'' and ϕ determine homeomorphic connected sums. Since h is a homeomorphism, ϕ' and ϕ'' certainly produce homeomorphic connected sums $M_1 \#_{\phi, \psi} M_2$ and $M_1 \#_{\phi'', \psi} M_2$. So it suffices to show that ϕ and ϕ'' produce homeomorphic connected sums. Although $\phi(D^n) = \phi''(D^n) \subseteq M_1$ coincide, there is still the problem that the gluing maps that they determine, of $\phi(\partial D^n)$ and $\phi''(\partial D^n)$ respectively with $\psi(\partial D^n) \subseteq M_2 \setminus \text{Int } \psi(D^n)$ differ.

However, we observe that the map

$$\phi^{-1} \circ \phi'' : S^{n-1} = \partial D^n \rightarrow \partial D^n = S^{n-1}$$

is an orientation preserving homeomorphism, so it is isotopic to the identity by Theorem 17.27, i.e. there is a family of homeomorphisms $F_t : \partial D^n \rightarrow \partial D^n$ with $F_0 = \phi^{-1} \circ \phi''$ and $F_1 = \text{Id}$. Now consider a homeomorphism

$$H : \phi(\partial D^n) \times I \rightarrow \phi(\partial D^n) \times I$$

$$(\phi(x), t) \mapsto (\phi \circ F_t(x), t).$$

Note that $H(\phi(x), 0) = (\phi''(x), 0)$ and $H(\phi(x), 1) = (\phi(x), 1)$. We will use H to define a homeomorphism of a collar of $\phi(\partial D^n) = \phi''(D^n)$, which exists by Brown's collaring Theorem 4.5 since $\phi(D^n)$ is locally collared by assumption. Fix a choice of such a collar

$$G : \phi(\partial D^n) \times I \rightarrow M_1 \setminus \text{Int } \phi(D^n),$$

with $G(\phi(\partial D^n) \times \{0\}) = \phi(\partial D^n)$. As $\phi(D^n) = \phi''(D^n)$ we have $M_1 \setminus \text{Int } \phi''(D^n) = M_1 \setminus \text{Int } \phi(D^n)$, and we can view G also as a collar for $\phi''(\partial D^n)$ in $M_1 \setminus \text{Int } \phi''(D^n)$. We define a homeomorphism $K: M_1 \#_{\phi, \psi} M_2 \rightarrow M_1 \#_{\phi'', \psi} M_2$ as in Fig. 17.7, namely

$$K(x) := \begin{cases} \text{Id}, & x \in M_2 \setminus \text{Int } \psi(D^n) \cup M_1 \setminus (\phi(D^n) \cup G(\phi(\partial D^n) \times I)), \\ G(H(\phi(x), t)), & x = G(\phi(y), t) \text{ for } y \in \partial D^n. \end{cases}$$

Since $H(\phi(x), 1) = (\phi(x), 1)$ the map K is continuous at $G(\phi(x), 1)$ for all $x \in \partial D^n$. Since

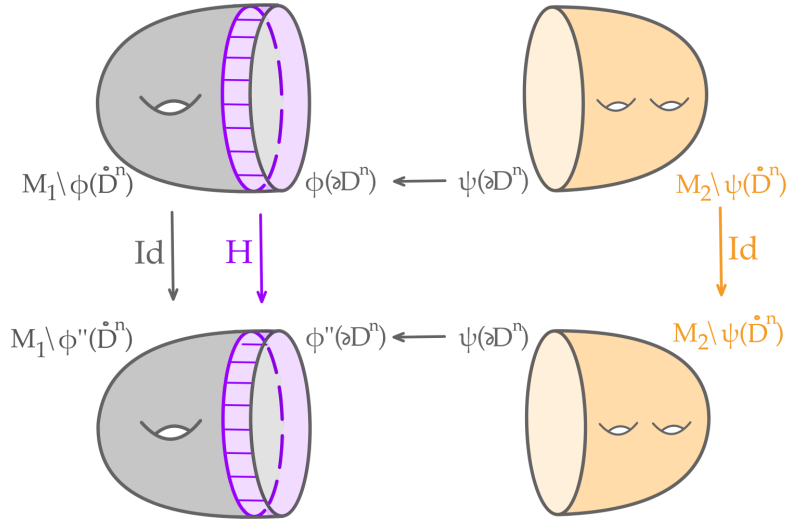

FIGURE 17.7. The final homeomorphism K .

$H(\phi(x), 0) = (\phi''(x), 1)$, and $(\phi(x), 0) \sim \psi(x)$ in the domain of K , whereas $(\phi''(x), 0) \sim \psi(x)$ in the codomain, the map is well-defined and continuous at $\phi(\partial D^n) = \psi(\partial D^n)$. This completes the proof that connected sum is well-defined for manifolds of dimension at least 6. \square

EXERCISE 17.1. (PS8.1) Prove that every homeomorphism $h: T^n \rightarrow T^n$ is stable, where T^n denotes the n -torus $S^1 \times \dots \times S^1$. *Hints:*

- Easy mode: Apply SH_n .
- Expert mode: The result can be proved independently of SH_n , and was the key step in Kirby’s proof of SH_n . (We sidestepped it by using a slightly stronger result about PL homotopy tori.) First prove the case where the induced map on fundamental groups is the identity. Then show that for any $n \times n$ matrix A with integer entries and determinant one, there exists a diffeomorphism $h: T^n \rightarrow T^n$ such that $h_* = A$ where $h_*: \pi_1(T^n, x) \rightarrow \pi_1(T^n, x)$. Prove that diffeomorphisms of T^n are stable.

EXERCISE 17.2. (PS8.2) Use the torus trick to show that a homeomorphism of \mathbb{R}^n is stable if and only if it is isotopic to the identity. *Hints:*

- (1) It suffices to show that the space of stable homeomorphisms of \mathbb{R}^n , denoted $S\text{Homeo}(\mathbb{R}^n)$, is both open and closed in $\text{Homeo}(\mathbb{R}^n)$.
- (2) Use the torus trick from our proof of local contractibility of $\text{Homeo}(\mathbb{R}^n)$ to show that an open neighbourhood of the identity in $\text{Homeo}(\mathbb{R}^n)$ consists of stable homeomorphisms. Conclude that every stable homeomorphism of \mathbb{R}^n has an open neighbourhood consisting of stable homeomorphisms.

- (3) Every coset of $S\text{Homeo}(\mathbb{R}^n)$ in $\text{Homeo}(\mathbb{R}^n)$ is open since $\text{Homeo}(\mathbb{R}^n)$ is a topological group. Conclude that $S\text{Homeo}(\mathbb{R}^n)$ is closed in $\text{Homeo}(\mathbb{R}^n)$.

EXERCISE 17.3. (PS9.1) Prove the “topological weak Palais theorem”. That is, let $n \geq 6$, let M be a connected n -manifold, and let $\phi, \psi: D^n \rightarrow \text{Int } M$ be locally collared embeddings. Then there exists a homeomorphism $h: M \rightarrow M$ with $h \circ \phi = \psi: D^n \rightarrow M$.

PL homotopy tori

Mark Powell

We give an outline of the surgery theoretic classification of closed n -manifolds homotopy equivalent to the torus T^n , for $n \geq 5$. This classification played a key rôle in the proof of the stable homeomorphism theorem.

This chapter will not contain proofs. It is intended to be understandable to those who do not have a background in surgery theory. Along the way we will try to point out where some key tools of PL manifold theory are being used, in the hope that this acts as motivation for our attempt to establish the same tools for topological manifolds. That is, given transversality, handle structures, and immersion theory, we will be able to apply surgery theory in the topological category to obtain similarly strong results on classification of topological manifolds within a homotopy type.

18.1. Classification theorems

The aim is to prove the following two theorems, due to Hsiang-Shaneson [HS69] and Wall [Wal69].

Remark 18.1. The most complete proof was given by Hsiang and Shaneson, although it seems that Wall knew the same result, and was in the middle of writing his extensive book on non-simply connected surgery theory when Kirby announced his proof of SH_n modulo the homotopy tori question. Kirby's proof still needed input from surgery theory, but the theory was so well developed by that point that this was a problem the experts could quickly solve. Wall produced a short announcement of the answer, promising details in his book. Hsiang-Shaneson announced the result at the same time, and using ideas of Farrell, were able to give their own account prior to Wall's book being completed. Perhaps due to this, Wall's book contains fewer details, so the more comprehensive account seems to be Hsiang-Shaneson [HS69].

THEOREM 18.2. *Let $n \geq 5$. There is a bijection between the set of closed PL n -manifolds $M \simeq T^n$, up to PL homeomorphism, and*

$$\frac{(\wedge^{n-3}\mathbb{Z}^n) \otimes \mathbb{Z}/2}{\mathrm{GL}_n(\mathbb{Z})}.$$

Here $\wedge^{n-3}\mathbb{Z}^n$ denotes the exterior algebra. The 0 element corresponds to T^n .

Example 18.3. For $n = 5$ we have that $(\wedge^2\mathbb{Z}^5) \otimes \mathbb{Z}/2 \cong (\mathbb{Z}/2)^{10}$, and the quotient by $\mathrm{GL}_5(\mathbb{Z})$ contains 3 elements, represented by 0, $e_1 \wedge e_2$ and $e_1 \wedge e_2 + e_3 \wedge e_4$. The key to checking this is to note that by change of bases

$$e_1 \wedge e_2 + e_2 \wedge e_3 \sim e_1 \wedge e_2 + e_2 \wedge (e_3 + e_1) = e_2 \wedge e_3 \sim e_1 \wedge e_2.$$

Thus even in dimension 5, where there are no exotic spheres, there are two fake PL-tori. That is, they are homotopy equivalent but not PL homeomorphic.

The proof of SH_n used the following result, which is stronger than just enumerating the homotopy tori.

THEOREM 18.4. *Let $n \geq 5$. Every closed PL n -manifold $M \simeq T^n$ has a finite cover PL-homeomorphic to T^n .*

Actually, the proof used a further refinement of this, namely that a lift of any homotopy equivalence is homotopic to a homeomorphism. This will be immediate from the fact that we work with the structure set.

Remark 18.5. The analogue of Theorem 18.2 in the smooth category does not hold, since one may connect sum on an exotic sphere, to produce new fake tori. On the other hand, this phenomenon disappears when we pass to finite covers, and the analogue of Theorem 18.4 is also true in the smooth category. In the topological category, there are no fake homotopy tori, but we will need to develop tools such as topological transversality in order to see this.

We will give an introduction to surgery theory in the specific case of the torus T^n . Perhaps this will help readers understand the general theory.

18.2. The structure set

Our primary aim will be to compute the *structure set* of T^n , the set of pairs:

$$\mathcal{S}_{PL}(T^n) := \left\{ (M^n \text{ closed PL manifold, } f: M \xrightarrow{\simeq} T^n) \right\} / s\text{-cobordism over } T^n.$$

Here, for the equivalence relation, (M, f) and (N, g) are s -cobordant over T^n if there is an $(n+1)$ -dimensional cobordism W with $\partial W = M \sqcup -N$ with a map $F: W \rightarrow T^n$ extending f and g , such that the inclusion maps $M \rightarrow W$ and $N \rightarrow W$ are simple homotopy equivalences. This means that W can be obtained from either M or N by a sequence of elementary expansions and collapses. See e.g. [Coh73], [DK01, final chapter], or Crowley-Lueck-Macko for more on simple homotopy type. Recall that if the same holds without the simple requirement, then W is called an h -cobordism over T^n .

Here are two simplifications of the structure set. First, it turns out that whether a homotopy equivalence is simple can be decided by an algebraic obstruction in the *Whitehead group*. For a group π , let $\mathbb{Z}[\pi]$ be the group ring, that is sums $\sum_{g \in \pi} n_g g$, with $n_g \in \mathbb{Z}$, and finitely many of the n_g nonzero.

THEOREM 18.6 (Bass-Heller-Swan [BHS64]). *For $n \geq 0$, the Whitehead group $\text{Wh}(\mathbb{Z}[\mathbb{Z}^n]) = 0$.*

This means that every matrix in $\text{GL}_k(\mathbb{Z}[\mathbb{Z}^n])$ can be converted into a diagonal matrix with entries $\pm g$ by a sequence of operations: taking a block sum with an identity matrix, reversing this operation, or elementary row and column operations. That $\text{Wh}(\mathbb{Z}) = 0$ is a straightforward consequence of the Euclidean algorithm. That $\text{Wh}(\mathbb{Z}[\mathbb{Z}^n]) = 0$ is a much harder theorem.

The algebraic moves in the Whitehead group mirror geometric handle moves that can be performed to a handle decomposition of an h -cobordism. In fact the vanishing of the Whitehead group implies that these moves can be done in order to cancel all handles.

THEOREM 18.7 (The s -cobordism theorem; Smale [Sma62a], Barden-Mazur-Stallings [Bar63, Sta67, Maz63]). *For $n \geq 5$, let $(W^{n+1}; M^n, N^n)$ be a PL s -cobordism. Then*

$$W \cong_{PL} M \times I \cong_{PL} N \times I.$$

In particular $M \cong_{PL} N$.

Remark 18.8. This is also true in the smooth category [Mil65]. It also holds in the topological category, although that needs the results of Kirby-Siebenmann [KS77b] that we are currently learning. In the topological category it also holds for $n = 4$, by work of Freedman and Quinn [FQ90] that we will not cover.

Remark 18.9. The proof of the s -cobordism theorem uses handle structures and transversality, so being able to establish versions of these tools for topological manifolds is a prerequisite for proving the topological s -cobordism theorem.

The outcome of these two theorems is that:

$$\mathcal{S}_{PL}(T^n) = \frac{\{f: M \xrightarrow{\cong} T^n\}}{h\text{-cobordism over } T^n} \cong \frac{\{f: M \xrightarrow{\cong} T^n\}}{s\text{-cobordism over } T^n} \cong \frac{\{f: M \xrightarrow{\cong} T^n\}}{\text{PL homeomorphism over } T^n}$$

for $n \geq 5$. So we see that computing the structure set is extremely relevant for the aim of classifying manifolds homotopy equivalent to T^n .

18.3. Normal bordism and the surgery obstruction

The idea of manifold classification via surgery theory is to invoke the power of bordism theory, and to introduce auxiliary stable normal bundle data. This is hard to motivate at first, but it turns out that introducing this extra data is what enables the whole machine to run. Here is an attempt at motivation. Homotopy equivalences are in particular degree one normal maps. Also h -cobordisms are in particular normal bordisms. The powerful machinery of bordism theory allows us to compute the set of degree normal maps up to normal bordism. In addition the normal bundle data provides just the right amount of extra control to enable the definition of an algebraic obstruction to a normal bordism class containing a homotopy equivalence.

The initial goal is to compute *normal bordism classes of degree one normal maps*. Here a degree one normal map is a bundle map

$$\begin{array}{ccc} \nu_M & \xrightarrow{F} & \xi \\ \downarrow & & \downarrow \\ M & \xrightarrow{f} & T^n. \end{array}$$

Here we assume that $M \subseteq \mathbb{R}^q$ for some large q and ν_M is the stable normal bundle, while ξ is some stable bundle. We will not discuss the correct notion of a PL bundle theory here. We require that f has degree one, that is both M and T^n are equipped with fundamental classes and $f_*: H_n(M) \rightarrow H_n(T^n)$ sends $[M]$ to $[T^n]$.

We consider degree one normal maps up to degree one normal bordism. That is a cobordism $(W^{n+1}; M, N)$ with data

$$\begin{array}{ccc} \nu_W & \xrightarrow{G} & \Xi \\ \downarrow & & \downarrow \\ W & \xrightarrow{g} & T^n \times I \end{array}$$

restricting to the given degree one normal maps $M \rightarrow T^n \times \{0\}$ and $N \rightarrow T^n \times \{1\}$, and such that $g_*: H_n(W, \partial W) \rightarrow H_n(T^n \times I, T^n \times \{0, 1\})$ preserves the relative fundamental classes.

Let $\mathcal{N}_{PL}(T^n)$ be the set of normal bordism classes of normal maps with target the PL manifold T^n .

THEOREM 18.10. *Let $n \geq 5$. A normal bordism class $[(M, f, F, \xi)]$ contains a homotopy equivalence $M \rightarrow T^n$ if and only if the surgery obstruction $\sigma(M, f, F, \xi) = 0 \in L_n(\mathbb{Z}[Z^n])$.*

Let us explain this theorem. The idea is to try to perform surgery (to be defined presently) on M to convert f into a homotopy equivalence. There is an algebraic obstruction to this in the L -group, which we will define. If the algebraic obstruction vanishes, then the sequence of surgeries exists as desired.

A surgery on an n -manifold consists of cutting out an embedding of $S^r \times D^{n-r}$, for some r , and gluing in $D^{r+1} \times S^{n-r-1}$ instead:

$$M' := M \setminus S^r \times \overset{\circ}{D}^{n-r} \cup_{S^r \times S^{n-r-1}} D^{r+1} \times S^{n-r-1}.$$

Associated with a surgery is a cobordism, called the trace of the surgery, given by

$$M \times I \cup D^{r+1} \times D^{n-r},$$

where $D^{r+1} \times D^{n-r}$ is attached along the given embedding $S^r \times D^{n-r}$ in $M \times \{1\}$.

Using Smale-Hirsch immersion theory (due to Haefliger-Poenaru [HP64] in the PL category), one can perform surgeries “below the middle dimension” to obtain $f': M' \rightarrow T^n$ with f' $\lfloor n/2 \rfloor$ -connected. That is, f' is an isomorphism on π_i for $0 \leq i < \lfloor n/2 \rfloor$ and is a surjection on $\pi_{\lfloor n/2 \rfloor}(M') \rightarrow \pi_{\lfloor n/2 \rfloor}(T^n)$. (In our case, the latter is automatic since $\pi_{\lfloor n/2 \rfloor}(T^n) = 0$.)

We want to kill $\ker(\pi_{\lfloor n/2 \rfloor}(M') \rightarrow \pi_{\lfloor n/2 \rfloor}(T^n)) = \pi_{\lfloor n/2 \rfloor}(M')$. We can do this by surgery if and only if $f': M' \rightarrow T^n$ is normally bordant to a homotopy equivalence, in which case we have a candidate for a fake torus. The fact that making a map an isomorphism on homotopy groups only up to the middle dimension suffices to achieve a homotopy equivalence follows from Poincaré duality, universal coefficients, and the Hurewicz and the Whitehead theorems. These last set of surgeries are possible if and only if an algebraic obstruction in the L -group $L_n(\mathbb{Z}[\mathbb{Z}^n])$, which we will soon define, vanishes. This obstruction is well-defined, meaning that it only depends on the original normal bordism class. In particular it is independent of the choices we made in the initial surgeries below the middle dimension, although this is not at all obvious. The L -groups are the obstructions to finding a collection of disjoint embeddings of $S^{\lfloor n/2 \rfloor} \times D^{n-\lfloor n/2 \rfloor}$, framed embedded spheres, such that surgery on them gives a homotopy equivalence $f'': M'' \rightarrow T^n$. We next define the L groups. Note that a group ring $\mathbb{Z}[\pi]$ has an involution defined by sending $g \mapsto g^{-1}$ and extending linearly.

Definition 18.11. In even degrees, $L_{2k}(\mathbb{Z}[\mathbb{Z}^n])$ is the group of nonsingular, $(-1)^k$ -Hermitian, sesquilinear forms on finitely generated, free $\mathbb{Z}[\mathbb{Z}^n]$ -modules, given by some $\varphi: P \rightarrow P^* = \text{Hom}_{\mathbb{Z}[\mathbb{Z}^n]}(P, \mathbb{Z}[\mathbb{Z}^n])$, and further equipped with a quadratic enhancement. We will not define quadratic enhancements in detail, but in particular note that a form with a quadratic enhancement is even. We impose the equivalence relation of *stable isometry*, where by definition φ and φ' are *Witt equivalent* if

$$\varphi \oplus \begin{pmatrix} 0 & 1 \\ (-1)^k & 0 \end{pmatrix}^a \cong \varphi' \oplus \begin{pmatrix} 0 & 1 \\ (-1)^k & 0 \end{pmatrix}^b.$$

The form $\begin{pmatrix} 0 & 1 \\ (-1)^k & 0 \end{pmatrix}$ on $\mathbb{Z}\pi \oplus \mathbb{Z}\pi$ is called the standard $(-1)^k$ -hyperbolic form.

In odd degrees, $L_{2k+1}(\mathbb{Z}[\mathbb{Z}^n])$ is the group of nonsingular *formations*. These are $(-1)^k$ hyperbolic forms with two lagrangians, that is half-rank summands on which the form vanishes. We shall not describe the equivalence relation on formations.

The data of a formation is rather like the algebraic data one can obtain from a Heegaard splitting of a 3-manifold.

We have now seen that the following is an exact sequence of sets:

$$\mathcal{S}_{PL}(T^n) \rightarrow \mathcal{N}_{PL}(T^n) \xrightarrow{\sigma} L_n(\mathbb{Z}[\mathbb{Z}^n]).$$

Here the first map is to consider normal bordism classes, and the second is the surgery obstruction map. Exactness encodes the theorem above that the surgery obstruction of a degree one normal map vanishes if and only if that normal bordism class contains a homotopy equivalence.

PROPOSITION 18.12. *For $[(M, f, F, \xi)] \in \mathcal{N}_{PL}(T^n)$, $\sigma(M, f, F, \xi) = 0$ if and only if (M, f, F, ξ) is normally bordant to $(T^n, \text{Id}, \text{Id}, \nu_{T^n})$. That is, there is a unique normal bordism class containing a homotopy equivalence.*

We will explain more about the computation of σ later, but first more on the overall strategy.

18.4. Wall realisation and the size of each normal bordism class

Once we know which normal bordism classes contain at least one homotopy equivalence, we can ask how many are there in each normal bordism class, and how many distinct PL manifolds does this give rise to. The first question amounts to completing the computation of the structure

set. We saw that every manifold homotopy equivalent to T^n is normally bordant to T^n . It helps to ask the following question.

Question 18.13. Given a normal bordism from M to T^n , is that normal bordism itself bordant (via a bordism of bordisms) to a homotopy equivalence, and hence to an h -cobordism?

If the answer is yes, then $(M, f) = (T^n, \text{Id})$ in $\mathcal{S}_{PL}(T^n)$ and $M \cong_{PL} T^n$. What about if we are allowed to first change the given normal bordism, and then ask this question? If the answer is no for all choices of initial normal bordism, then indeed the pairs (M, f) and (T^n, Id) must be distinct.

PROPOSITION 18.14 (Browder [Bro72], Novikov [Nov64], Wall). *A normal bordism (W, g, G, Ξ) over $T^n \times I$ is normally bordant to an h -cobordism if and only if its surgery obstruction $\sigma(W, g, G, \Xi) = 0 \in L_{n+1}(\mathbb{Z}[\mathbb{Z}^n])$.*

In fact, all possible surgery obstructions can be realised for normal bordisms, fixing one end of the normal bordism but not the other.

THEOREM 18.15 (Wall). *The group $L_{n+1}(\mathbb{Z}[\mathbb{Z}^n])$ acts on $\mathcal{S}_{PL}(T^n)$ with stabiliser*

$$\text{Im}(\sigma: \mathcal{N}_{PL}(T^n \times I, T^n \times \{0, 1\}) \rightarrow L_{n+1}(\mathbb{Z}[\mathbb{Z}^n])).$$

The action produces a normal bordism starting with (T^n, Id) with any given surgery obstruction. The output of the action is the homotopy equivalence obtained by restricting to the other end of the constructed normal bordism.

We deduce that

$$\mathcal{S}_{PL}(T^n) \leftrightarrow \frac{L_{n+1}(\mathbb{Z}[\mathbb{Z}^n])}{\text{Im } \sigma}.$$

Wall realisation extends the sequence above to the surgery exact sequence:

$$\mathcal{N}_{PL}(T^n \times I, T^n \times \{0, 1\}) \xrightarrow{\sigma} L_{n+1}(\mathbb{Z}[\mathbb{Z}^n]) \rightarrow \mathcal{S}_{PL}(T^n) \rightarrow \mathcal{N}_{PL}(T^n) \xrightarrow{\sigma} L_n(\mathbb{Z}[\mathbb{Z}^n]).$$

PROPOSITION 18.16. *We have*

$$\frac{L_{n+1}(\mathbb{Z}[\mathbb{Z}^n])}{\text{Im } \sigma} \cong (\wedge^{n-3} \mathbb{Z}^n) \otimes \mathbb{Z}/2.$$

Thus $|\mathcal{S}_{PL}(T^n)| = 2^{\binom{n}{3}}$, all in the normal bordism class of the identity.

Now, how many distinct manifolds does this entail? We have to factor out by the choice of homotopy equivalence to T^n . Note that $T^n \simeq K(\mathbb{Z}^n, 1)$, since the universal cover is \mathbb{R}^n , which is contractible. Thus homotopy self-equivalences of T^n up to homotopy are in bijection with isomorphisms of $\pi_1(T^n) \cong \mathbb{Z}^n$, in other words with $\text{GL}_n(\mathbb{Z})$. Therefore the manifold set is given by:

$$m_{PL}(T^n) = \frac{\{M^n \mid M \simeq T^n\}}{\text{PL-homeomorphism}} \cong \frac{\mathcal{S}_{PL}(T^n)}{\text{self-homotopy equivalences}} \cong \frac{(\wedge^{n-3} \mathbb{Z}^n) \otimes \mathbb{Z}/2}{\text{GL}_n(\mathbb{Z})}.$$

This completes our sketch of the proof of Theorem 18.2. We could leave Proposition 18.12 and Proposition 18.16 as black boxes. But we also want to understand Theorem 18.4, and for that we will need to understand the proofs of these propositions.

18.5. Computations of the surgery obstruction maps

We want to know that for any homotopy torus $M \simeq T^n$, the 2^n -fold cover corresponding to the kernel of $\mathbb{Z}^n \rightarrow (\mathbb{Z}/2)^n$, sending $e_i \mapsto e_i$, satisfies $\widetilde{M} \cong_{PL} T^n$.

18.5.1. The L -groups. First, the L -groups of $\mathbb{Z}[\mathbb{Z}^n]$ are known.

THEOREM 18.17 (Shaneson). *Let G be a finitely presented group and suppose that $\text{Wh}(\mathbb{Z}[G]) = 0$. Then*

$$L_m(\mathbb{Z}[\mathbb{Z} \times G]) \cong L_m(\mathbb{Z}[G]) \oplus L_{m-1}(\mathbb{Z}[G]).$$

This proof is a geometric proof of an algebraic fact, and uses transversality. It is the algebraic analogue of the geometric splitting in bordism groups

$$\Omega_m(X \times S^1) \cong \Omega_m(X) \oplus \Omega_{m-1}(X).$$

COROLLARY 18.18.

$$L_m(\mathbb{Z}[\mathbb{Z}^n]) \cong \bigoplus_{0 \leq i \leq n} \bigoplus \binom{n}{i} L_{m-i}(\mathbb{Z}).$$

The L -groups of \mathbb{Z} are given as follows. They are 4-periodic for $j \geq 0$.

$$L_j(\mathbb{Z}) \cong \begin{cases} \mathbb{Z} & j \equiv 0 \pmod{4} \\ 0 & j \equiv 1 \pmod{4} \\ \mathbb{Z}/2 & j \equiv 2 \pmod{4} \\ 0 & j \equiv 3 \pmod{4}. \end{cases}$$

For $j \equiv 2$, the nontrivial element is detected by an Arf invariant, which depends on the quadratic enhancement. For $j \equiv 0$, the isomorphism is given by taking the signature of the form, and dividing by 8. It is an algebraic fact that every symmetric, even, nonsingular form has signature divisible by 8.

18.5.2. Normal invariants. Next we bring in Sullivan's work, to compute $n_{PL}(T^n)$. The general fact, for a manifold or more generally for a Poincaré complex X with $n_{PL}(X) \neq \emptyset$ is that

$$n_{PL}(X) \cong [X, G/PL].$$

Here square brackets indicate homotopy classes of maps. This translates a bordism question into a homotopy theory question. It is particularly useful because, as we shall see, the homotopy groups of G/PL can be determined, as a consequence of the PL Poincaré conjecture. Let us introduce the notation.

- G_n is the monoid of homotopy self-equivalences of S^{n-1} .
- PL_n is the PL-homeomorphisms of \mathbb{R}^n fixing 0. (In fact to define this space carefully uses semi-simplicial spaces, which will be too much of a distraction for now. So we shall conveniently lie about it, and we will return to the proper definition later when we study smoothing theory.)
- $G := \text{colim}_{\rightarrow n} G_n$ is the colimit. Here given $f: S^{n-1} \rightarrow S^{n-1}$ we can take its reduced suspension $\Sigma f: \Sigma S^{n-1} \cong S^n \rightarrow \Sigma S^{n-1} \cong S^n$, which gives the maps in the directed system needed for the colimit.
- $PL = \text{colim}_{\rightarrow n} PL_n$. Here a PL-homeomorphism of \mathbb{R}^n induces one of \mathbb{R}^{n+1} by taking the product with $\text{Id}_{\mathbb{R}}$.

Using these, BG and BPL are the associated classifying spaces. Similarly BG_n and BPL_n are the versions prior to taking colimits. In particular BG_n is the classifying space for fibrations with fibre S^{n-1} , BPL_n is the classifying space for \mathbb{R}^n fibre bundles with PL_n structure group, BG is the classifying space for stable spherical fibrations, and BPL is the classifying space for stable classes of PL bundles. A classifying space can be constructed using semi-simplicial techniques. Again we will postpone the precise definitions. At this point, what we need to know is that for a CW complex X , homotopy classes of maps, for examples $[X, BG_n]$, are in bijective correspondence with fibre homotopy equivalence classes of fibrations with fibre homotopy equivalent to S^{n-1} , and $[X, BPL_n]$ is in bijective correspondence with isomorphism classes of

\mathbb{R}^n fibre bundles with PL_n structure group. Similarly $[X, BG]$ and $[X, BPL]$ correspond to equivalence classes of stable fibrations and fibre bundles respectively.

The forgetful map $BPL \rightarrow BG$ has *homotopy fibre* G/PL , so there is a fibration sequence

$$G/PL \rightarrow BPL \xrightarrow{\psi} BG$$

with

$$G/PL = \{(x, \gamma) \mid x \in BPL, \gamma: [0, 1] \rightarrow BG, \gamma(0) = \psi(x), \gamma(1) = \text{basepoint of } BG\}.$$

The bijection $n_{PL}(X) \cong [X, G/PL]$ works as follows. Let X be a compact n -manifold for simplicity. Then X has a spherical normal fibration coming from embedding X in Euclidean space. Fixing one PL normal bundle, the different lifts of the spherical normal fibration are in bijective correspondence with $[X, G/PL]$. Each such lift corresponds to a PL bundle over X embedding in S^N for some N . There is an associated collapse map from S^N to the Thom space of the PL normal bundle. Make this map transverse to the zero section and take the inverse image. This yields a manifold $M \subseteq S^N$ with a degree one map to the zero section X . Pulling back the bundle which equals the normal bundle of X in the Thom space gives a bundle over M , with a bundle map. So we obtain a degree one normal map. It turns out that this method gives rise to the claimed bijection.

One key fact about G/PL is that it can be delooped. That is, for some space Y we have $G/PL \simeq \Omega Y$. This is due to Boardman-Vogt [BV68]. Using this we can specialise to $X = T^n$ and compute:

$$[T^n, G/PL] = [T^n, \Omega Y] = [\Sigma T^n, Y] = [\bigvee S^{k+1}, Y] = [\bigvee S^k, \Omega Y] = [\bigvee S^k, G/PL].$$

Here we use that in a CW decomposition of T^n , all the attaching maps become null-homotopic after suspension. This reduces ΣT^n to a wedge of spheres. We have been imprecise with which spheres are involved. There is one wedge summand S^{k+1} for each k -cell of T^n , with $k \geq 1$.

Let us consider the surgery exact sequence for S^n . We have

$$[\Sigma S^n, G/PL] \rightarrow L_{n+1}(\mathbb{Z}) \rightarrow \mathcal{S}_{PL}(S^n) \rightarrow [S^n, G/PL] \rightarrow L_n(\mathbb{Z}) \rightarrow \dots$$

By the PL Poincaré conjecture, $\mathcal{S}_{PL}(S^n) \cong \{[S^n]\}$ for $n \geq 5$. Therefore for $n \geq 6$ we have:

$$\pi_n(G/PL) \cong L_n(\mathbb{Z}) \cong \begin{cases} \mathbb{Z} & j \equiv 0 \pmod{4} \\ 0 & j \equiv 1 \pmod{4} \\ \mathbb{Z}/2 & j \equiv 2 \pmod{4} \\ 0 & j \equiv 3 \pmod{4}. \end{cases}$$

In particular $\pi_n(G/PL)$ is 4-periodic. We can compute what happens in the low dimensions using knowledge of the homotopy groups of G and $O = \text{colim}_n O(n)$. Here is a summary, which relies on a certain amount of background knowledge. We will quote the relevant facts, to at least give some indication of what is needed. It is all independent of the theory of topological manifolds. There is a fibration

$$PL/O \rightarrow BO \rightarrow BPL$$

where PL/O is by definition the homotopy fibre.

THEOREM 18.19. *The space PL/O is 6-connected.*

This follows from classical, deep theorems on smoothing PL manifolds in low dimensions. The long exact sequence in homotopy groups

$$\pi_n(PL/O) \rightarrow \pi_n(G/O) \rightarrow \pi_n(G/PL) \rightarrow \pi_{n-1}(PL/O)$$

for $n \leq 6$ implies that $\pi_n(G/PL) \cong \pi_n(G/O)$ for $n \leq 6$. The homotopy groups of BG are related to the stable homotopy groups of spheres by a shift. The homotopy groups of BO are known by

Bott periodicity. The homotopy groups are connected by the J homomorphism. We have a long exact sequence

$$\cdots \rightarrow \pi_2(G/O) \rightarrow \pi_2(BO) \xrightarrow{J} \pi_2(BG) \rightarrow \pi_1(G/O) \rightarrow \pi_1(BO) \xrightarrow{J} \pi_1(BG)$$

We also know the following information on the groups and the maps in this sequence

$$\begin{array}{ccc} \pi_1(BO) & \xrightarrow{J} & \pi_1(BG) \\ \downarrow \cong & & \downarrow \cong \\ \mathbb{Z}/2 & \xrightarrow{\cong} & \mathbb{Z}/2 \end{array}$$

$$\begin{array}{ccc} \pi_2(BO) & \xrightarrow{J} & \pi_2(BG) \\ \downarrow \cong & & \downarrow \cong \\ \mathbb{Z}/2 & \xrightarrow{\cong} & \mathbb{Z}/2 \end{array}$$

$$\begin{array}{ccc} \pi_3(BO) & \xrightarrow{J} & \pi_3(BG) \\ \downarrow \cong & & \downarrow \cong \\ 0 & \longrightarrow & \mathbb{Z}/2 \end{array}$$

$$\begin{array}{ccc} \pi_4(BO) & \xrightarrow{J} & \pi_4(BG) \\ \downarrow \cong & & \downarrow \cong \\ \mathbb{Z} & \longrightarrow & \mathbb{Z}/24. \end{array}$$

In addition $\pi_5(BG) = \pi_5(BO) = \pi_6(BG) = 0$. It is then straightforward to compute that the 4-periodicity persists into the low dimensions, namely for $n \in \{1, 2, 3, 4, 5\}$ we have:

$$\pi_n(G/PL) \cong \begin{cases} 0 & n = 1, 3, 5 \\ \mathbb{Z}/2 & n = 2 \\ \mathbb{Z} & n = 0, 4. \end{cases}$$

So in fact $\pi_n(G/PL) \cong L_n(\mathbb{Z})$ for all $n \geq 0$. Moreover,

$$[T^n, G/PL] \cong n_{PL}(T^n) \cong \bigoplus_{0 \leq i < n} \bigoplus \binom{n}{i} L_{n-i}(\mathbb{Z})$$

and

$$L_n(\mathbb{Z}[\mathbb{Z}^n]) \cong \bigoplus_{0 \leq i \leq n} \bigoplus \binom{n}{i} L_{n-i}(\mathbb{Z})$$

are almost isomorphic, the only difference being the extra copy of $L_0(\mathbb{Z}) \cong \mathbb{Z}$ when $i = n$ that appears in $L_n(\mathbb{Z}[\mathbb{Z}^n])$.

18.5.3. The surgery obstruction map is injective.

PROPOSITION 18.20. *The surgery obstruction map $\sigma: [T^n, G/PL] \rightarrow L_n(\mathbb{Z}[\mathbb{Z}^n])$ is injective.*

Proof. Here is a sketch of the proof. Suppose that $\xi \in [T^n, G/PL]$ (we use the notation for a bundle since the set $[T^n, G/PL]$ indexes PL fibre bundles lifting the normal spherical fibration). Suppose that $\sigma(\xi) = 0$. We induct on n . Since $\pi_1(G/PL) = 0$, the base case holds.

We are going to ignore issues with low dimensions for this sketch. Really at the start of the induction we should cross with $\mathbb{C}P^2$ to get into sufficiently high dimensions, and use that crossing with $\mathbb{C}P^2$ realises the 4-periodicity of the surgery obstruction. To avoid the details of

this, let us assume we have already done the induction as far as $n = 5$. Recall the computation above that gives the first equality:

$$[T^n, G/PL] = [\bigvee S^{k+1}, Y] = \prod [S^{k+1}, Y] = \prod [S^k, G/PL].$$

The maps in the product are sent under σ to the surgery obstructions of sub-tori $T^k \subseteq T^n$. They are null-homotopic by the inductive hypothesis, except for on the top cell. To understand the obstruction on the top cell we have the following diagram.

$$\begin{array}{ccc} [T^n, G/PL] & \longrightarrow & L_n(\mathbb{Z}[\mathbb{Z}^n]) \\ \uparrow & & \uparrow \\ [S^n, G/PL] & \xrightarrow{\cong} & L_n(\mathbb{Z}) \end{array}$$

Here the left vertical arrow is given by collapsing the $(n - 1)$ -skeleton. That the right vertical arrow is injective follows easily from the definitions: a stable isometry over $\mathbb{Z}[\mathbb{Z}^n]$ augments to one over \mathbb{Z} . Since the right-then-up route is an injection, it follows that $\xi = 0$ as desired. \square

This shows that indeed there is a unique normal bordism class in $\mathcal{N}_{PL}(T^n)$ that contains a homotopy equivalence.

18.5.4. Constructing normal maps producing given elements of $L_{n+1}(\mathbb{Z}[\mathbb{Z}^n])$. We are left with the question: what is the image of σ ? On the left of the surgery exact sequence, this image in $L_{n+1}(\mathbb{Z}[\mathbb{Z}^n])$ equals the stabiliser of $\text{Id}_{T^n} \in \mathcal{S}_{PL}(T^n)$, and the orbit of this element is what we want to compute.

We construct the degree one normal maps that give elements of $L_{n+1}(\mathbb{Z}[\mathbb{Z}^n])$, as suggested by the title of this section. Let $J \subseteq \{1, \dots, n\}$ and write

$$H := \{1, \dots, n\} \setminus J.$$

These subsets correspond to sub-tori $T_J, T_H \subseteq T^n$. For example if $J = \{1, 2, 4\} \subseteq \{1, \dots, 5\}$ then $T_J = S^1 \times S^1 \times \{*\} \times S^1 \times \{*\}$. Write

$$m = |J|.$$

Let

$$\begin{array}{ccc} \nu_M & \xrightarrow{F} & \xi \\ \downarrow & & \downarrow \\ M & \xrightarrow{f} & D^{m+1} \end{array}$$

be a degree one normal map, restricting to a PL homeomorphism on the boundary $\partial M \rightarrow S^m$, realising the generator of

$$L_{m+1}(\mathbb{Z}) \cong \begin{cases} \mathbb{Z} & m + 1 \equiv 0 \pmod{4} \\ 0 & m + 1 \equiv 1 \pmod{4} \\ \mathbb{Z}/2 & m + 1 \equiv 2 \pmod{4} \\ 0 & m + 1 \equiv 3 \pmod{4}. \end{cases}$$

if $m + 1 \neq 4$. If $m + 1 = 4$, then we instead realise twice the generator of $L_4(\mathbb{Z}) \cong \mathbb{Z}$. Such a degree one normal map exists by Kervaire and Milnor's plumbing construction, which is a special case of Wall realisation. This gives such an element for $n \neq m + 1$. Part of this construction is the fact that an m -dimensional homology sphere bounds a contractible $(m + 1)$ -dimensional PL manifold. This is true by surgery methods for $m + 1 \geq 5$, but it is not true for $m = 3$ in general. For example the Poincaré homology sphere does not bound a contractible PL 4-manifold. More generally, we have Rochlin's important theorem. This theorem will be the underlying source of the main differences between the PL and topological categories in high dimensions.

THEOREM 18.21 (Rochlin [Roc52]). *Let X be a smooth or PL, closed, spin 4-manifold. Then 16 divides the signature of X .*

Therefore it is not possible to realise the generator of $L_4(\mathbb{Z})$ by a degree one normal map $M \rightarrow D^4$. Here the signature of X is the signature of the middle dimensional intersection form on $H_2(X; \mathbb{R})$, which is nonsingular.

Spin 4-manifolds have even intersection forms, by the Wu formula $w_2(X) \cap x = x \cdot x \in \mathbb{Z}/2$ for all $x \in H_2(X; \mathbb{Z})$. Then it is an algebraic fact that 8 divides the signature. The converse, that even intersection form implies spin, is also true if $H_1(X; \mathbb{Z})$ has no 2-torsion. That 16 divides the signature uses the existence of a smooth or PL structure. In fact Freedman showed that there is a simply-connected topological 4-manifold with even intersection form and signature 8, so Rochlin’s theorem does not hold for topological 4-manifolds.

It is perhaps rather remarkable that this theorem on 4-manifolds will have so many consequences for high dimensional manifolds.

Now we construct the normal maps desired. We use the boundary connected sum \natural in the construction, which means choosing a copy of D^m in $T_J \times \{1\}$ and in ∂M , and identifying them. Take $N \rightarrow T^m \times I$ to be the normal bordism over $T^m \times I$ given by:

$$\begin{array}{ccc} N & \xrightarrow{=} & ((T_J \times I) \natural M) \times T_H \\ \downarrow & & \downarrow \\ T^m \times I & \xrightarrow{=} & ((T_J \times I) \natural D^{m+1}) \times T_H \end{array}$$

These can be concatenated, and sums of them realised every element of $L_{n+1}(\mathbb{Z}[\mathbb{Z}^n])$ except for the summand

$$\bigoplus^{\binom{n}{n-3}} L_4(\mathbb{Z}) \cong \bigoplus^{\binom{n}{n-3}} \mathbb{Z} \cong \wedge^{n-3} \mathbb{Z}^n.$$

Note that $(n + 1) - (n - 3) = 4$. In this summand, only the even elements are realised.

So to get nontrivial manifolds τ^n homotopy equivalent to T^n , apply Wall realisation to $\text{Id}: T^n \rightarrow T^n$ with an element of $\bigoplus^{\binom{n}{n-3}} L_4(\mathbb{Z})$ with a nonzero number of odd entries. The manifold on the far end of the resulting normal bordism will be a homotopy torus that is not PL homeomorphic to T^n .

18.5.5. Detecting homotopy tori. Suppose that we have an n -manifold $N \simeq T^n$ that we wish to show is not homeomorphic to T^n . We describe an obstruction for doing this. We will see that the obstruction vanishes in the 2^n -fold cover, which will complete our sketch of the proof of Theorem 18.4.

Let N be a closed PL n -manifold, $n \geq 5$, and let $f: N \xrightarrow{\simeq} T^n$ be a homotopy equivalence. Let $((W; N, T^n)$ be a normal bordism over $T^n \times I$ with $F: W \rightarrow T^n \times I$, and $F|_{T^n} = \text{Id}: T^n \rightarrow T^n \times \{1\}$ and $F|_N = f: N \rightarrow T^n \times \{0\}$. Let $J \subseteq \{1, \dots, n\}$ be a subset with $|J| = 3$, and consider the corresponding subtorus $T_J \subseteq T^n$. Also let $H := \{1, \dots, n\} \setminus J$. Consider

$$F \times \text{Id}: W \times \mathbb{C}\mathbb{P}^2 \rightarrow T^n \times I \times \mathbb{C}\mathbb{P}^2.$$

This raises the dimensions sufficiently to be able to apply high dimensional surgery theory and the Whitney trick when we need it. Make $F \times \text{Id}$ transverse, using PL-transversality, to $T_J \times I \times \mathbb{C}\mathbb{P}^2$. This is codimension $n - 3$ in $T^n \times I \times \mathbb{C}\mathbb{P}^2$ and therefore the inverse image of $T_J \times I \times \mathbb{C}\mathbb{P}^2$ is dimension $n + 1 + 4 - (n - 3) = 8$. By a result called the Farrell-Hsiang splitting theorem, and the fact that $\text{Wh}(\mathbb{Z}[\mathbb{Z}^n]) = 0$, we can assume that the inverse image is a homotopy equivalence on the boundary. We take the surgery obstruction of

$$(F \times \text{Id})^{-1}(T_J \times I \times \mathbb{C}\mathbb{P}^2) \rightarrow T_J \times I \times \mathbb{C}\mathbb{P}^2$$

in

$$L_8(\mathbb{Z}) \cong \mathbb{Z}$$

$$(P, \varphi) \mapsto \text{sign}(\varphi \otimes \mathbb{R})/8,$$

that is we take the signature of the intersection form and divide it by 8. Then we consider this modulo 2 in $\mathbb{Z}/2$. It turns out that this is independent of the choice of bordism W . This procedure gives a function

$$\Upsilon: \{J \subseteq \{1, \dots, n\} \mid |J| = 3\} \rightarrow \mathbb{Z}/2.$$

This can be translated to an element of $(\wedge^{n-3}\mathbb{Z}^n) \otimes \mathbb{Z}/2$. This gives the bijection we claimed

$$\mathcal{S}_{PL}(T^n) \cong (\wedge^{n-3}\mathbb{Z}^n) \otimes \mathbb{Z}/2.$$

Hsiang-Shaneson also show that the action of $\text{GL}_n(\mathbb{Z})$ is equivariant with respect to this bijection, so that the classification of PL homotopy tori is as claimed.

Finally, we see from the description of the obstruction that passing to the 2^n fold cover \tilde{N} of N , and therefore to the corresponding cover of W , will have the effect of replacing each inverse image of $T_J \times I \times \mathbb{C}\mathbb{P}^2$ by an even number of copies of itself. Therefore the associated map Υ will be identically zero, so that $\tilde{N} \cong_{PL} T^n$, as desired for Theorem 18.4.

Remark 18.22. Throughout the chapter, we have used simple homotopy type for PL manifolds, PL transversality, PL immersion theory, and we have mentioned smooth handlebody theory. These tools are essential for developing and using surgery theory. Having seen these tools be so important in the remarkable classification theorem for homotopy tori that we have just discussed, the reader of this chapter will now hopefully be motivated to learn these methods in the topological category. With their help, we will be able to apply similar methods to classify topological manifolds. These will be consequences of the Product Structure Theorem, which we will study soon.

We also remark that in the calculations, we used a number of deep results from algebraic topology, in particular on the J homomorphism, on stable homotopy groups of spheres, and on the homotopy groups of BO , as well as Rochlin's theorem.

EXERCISE 18.1. (PS9.2) Up to PL-homeomorphism, how many closed PL manifolds homotopy equivalent to T^6 are there?

Local contractibility for manifolds and isotopy extension

Arunima Ray

The goal of this section is to review the main results of Edwards and Kirby [EK71a]. This paper builds on the ideas of Kirby from [Kir69], and in particular, we will see another torus trick. This will be similar in flavour to the proof of Theorem 15.4, and we will work purely in the topological category (other than the initial input of an immersed torus) – no further input from PL topology will be necessary. In particular, there are no dimension restrictions in this section.

We will highlight two results. The following was first proved by Černavskii using push-pull methods. We will give the torus trick proof from [EK71a].

THEOREM 19.1 ([Č73, EK71a]). *If M is a compact manifold, then $\text{Homeo}(M)$ is locally contractible.*

For the next result, we need some preliminary definitions, see Fig. 19.1.

Definition 19.2. Let M be a manifold and $U \subseteq M$ a subset, with the inclusion denoted by $g: U \hookrightarrow M$. An embedding $h: U \hookrightarrow M$ is *proper* if $h^{-1}(\partial M) = g^{-1}(U)$. An isotopy $h_t: U \rightarrow M$ is *proper* if each h_t is proper.

Definition 19.3. A proper isotopy $h_t: N \rightarrow M$ is *locally flat* if for each $(x, t) \in N \times [0, 1]$ there exists a neighbourhood $[t_0, t_1]$ of $t \in [0, 1]$ and level preserving embeddings $\alpha: D^n \times [t_0, t_1] \rightarrow N \times [0, 1]$ and $\beta: D^n \times D^{m-n} \times [t_0, t_1] \rightarrow M \times [0, 1]$ onto neighbourhoods of (x, t) such that the following diagram commutes:

$$\begin{array}{ccc} D^n \times 0 \times [t_0, t_1] & \longrightarrow & D^n \times D^{m-n} \times [t_0, t_1] \\ \downarrow \alpha & & \downarrow \beta \\ N \times [0, 1] & \xrightarrow{(x,t) \mapsto (h_t(x), t)} & M \times [0, 1] \end{array}$$

Recall that the bottom map is called the *track* of the isotopy.

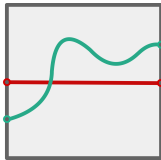

(A) Red inclusion $B^1 \subseteq B^1 \times B^1$ and a green proper embedding.

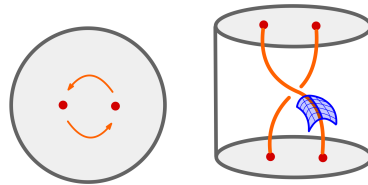

(B) Locally flat isotopy and its track.

FIGURE 19.1

The definition of a locally flat isotopy says that the track is a locally flat submanifold in a level preserving way. Since the track is in particular locally flat, we infer that, for example, the naïve isotopy taking the trefoil to the unknot is not locally flat. This can be seen using local fundamental groups.

THEOREM 19.4 (Isotopy extension theorem [EK71a, Corollary 1.2, Corollary 1.4], [Lee69]).

- (1) Let $h_t: C \rightarrow M$, $t \in [0, 1]$ be a proper isotopy of a compact set $C \subseteq M$, such that h_t extends to a proper isotopy of a neighborhood $U \supseteq C$. Then h_t can be covered by an (ambient) isotopy, that is, there exists $H_t: M \rightarrow M$, satisfying $H_0 = \text{Id}_M$ and $h_t = H_t \circ h_0$ for all $t \in [0, 1]$.
- (2) For manifolds M and N with N compact, any locally flat proper isotopy $h_t: N \rightarrow M$ is covered by an ambient isotopy. If $h_t = h_0$ for all t on a neighbourhood of ∂N , then we may assume that $H_t|_{\partial M} = \text{Id}_{\partial M}$.

In both cases, we may assume that H has compact support, that is, $H_t = \text{Id}_M$ outside some compact set, for each t .

Remark 19.5. Part (a) of the theorem above was proved independently in both [EK71a] and [Lee69]. Both papers use techniques of Kirby from [Kir69].

19.1. Handle straightening

We will consider the following spaces of embeddings.

Definition 19.6. For a manifold M and subsets $C \subseteq U \subseteq M$ we define

$$\text{Emb}_C(U, M) := \{f: U \hookrightarrow M \mid f \text{ is proper, } f|_C = \text{incl}\},$$

equipped with the compact open topology. If $C = \emptyset$ we write $\text{Emb}(U, M)$.

The following lemma is the key ingredient in [EK71a]. The proof will use the torus trick. Throughout this section, the notation rB^i refers to the i -dimensional closed ball of radius r centred at the origin in \mathbb{R}^i .

LEMMA 19.7 (Handle straightening). *There exists a neighbourhood $Q \subseteq \text{Emb}_{\partial B^k \times 4B^n}(B^k \times 4B^n, B^k \times \mathbb{R}^n)$ of the inclusion $\eta: B^k \times 4B^n \hookrightarrow B^k \times \mathbb{R}^n$, and a deformation of Q into the subspace $\text{Emb}_{\partial B^k \times 4B^n \cup B^k \times B^n}(B^k \times 4B^n, B^k \times \mathbb{R}^n)$, modulo $\partial(B^k \times 4B^n)$, and fixing η .*

In more detail, such a deformation of Q is a map

$$\Psi: Q \times [0, 1] \rightarrow \text{Emb}_{\partial B^k \times 4B^n}(B^k \times 4B^n, B^k \times \mathbb{R}^n)$$

for which

- (1) $\Psi(Q \times 1) \subseteq \text{Emb}_{\partial B^k \times 4B^n \cup B^k \times B^n}(B^k \times 4B^n, B^k \times \mathbb{R}^n)$.
- (2) $\Psi(h, t)|_{\partial(B^k \times 4B^n)} = h|_{\partial(B^k \times 4B^n)}$ for all $h \in Q$ and $t \in [0, 1]$, and
- (3) $\Psi(\eta, t) = \eta$ for all $t \in [0, 1]$.

The proof of this lemma is analogous to the proof of the Černavskiĭ-Kirby theorem we saw in Section 15.2. The goal will be to construct $\tilde{h} \in \text{Homeo}(B^k \times \mathbb{R}^n)$ for an h suitably close to η , such that

$$\tilde{h}|_{B^k \times B^n} = h|_{B^k \times B^n} \quad \text{and} \quad \tilde{h}|_{\partial B^k \times B^n \cup B^k \times (\mathbb{R}^n \setminus \text{Int } 3B^n)} = \text{Id}.$$

We will then use an Alexander isotopy \tilde{H}_t of the target space $B^k \times \mathbb{R}^n$ from Id to \tilde{h} to define the desired deformation:

$$\Psi(h, t) := \tilde{H}_t^{-1} \circ h.$$

Indeed, $\Psi(h, 0) = h$ and the restriction of $\Psi(h, 1) = \tilde{h}^{-1} \circ h$ to the core region is the standard inclusion, since \tilde{h} and h agree there. We will arrange to have Ψ constant on $\partial(B^k \times 4B^n)$. Our construction will be “canonical”, so the different isotopies can be sewn together to produce the desired map $\Psi: Q \times [0, 1] \rightarrow \text{Emb}_{\partial B^k \times 4B^n}(B^k \times 4B^n, B^k \times \mathbb{R}^n)$.

Proof. Let C_1 denote a collar of ∂B^k in B^k and let C denote $C_1 \times 3B^n$. It suffices to consider $h \in \text{Emb}_{\partial B^k \times 4B^n \cup C}(B^k \times 4B^n, B^k \times \mathbb{R}^n)$ by [EK71a, Proposition 3.2]. Roughly speaking, by using the collar C , the proposition gives an explicit deformation from a neighbourhood of η in $\text{Emb}_{\partial B^k \times 4B^n}(B^k \times 4B^n, B^k \times \mathbb{R}^n)$ to $\text{Emb}_{\partial B^k \times 4B^n \cup C}(B^k \times 4B^n, B^k \times \mathbb{R}^n)$.

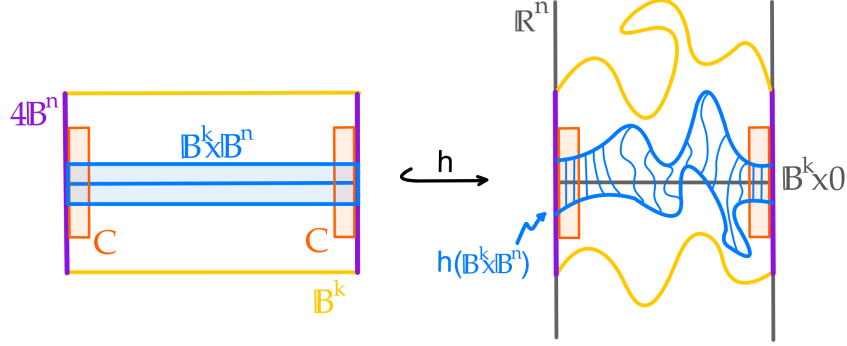

FIGURE 19.2. The setup of the Handle Straightening Lemma 19.7.

Thus, we begin with a setup as in Fig. 19.2. Our goal is to build $\tilde{h} \in \text{Homeo}(B^k \times \mathbb{R}^n)$ such that

$$\tilde{h}|_{\partial B^k \times \mathbb{R}^n \cup B^k \times (\mathbb{R}^n \setminus \text{Int}(3B^n))} = \text{Id} \quad \text{and} \quad \tilde{h}|_{B^k \times B^n} = h|_{B^k \times B^n}.$$

Let $S^1 := [-4, 4] \setminus \sim$, so that $T^n \supseteq aB^n$ for $a < 4$. Define $B^n := [-1, 1]^n$. Choose closed, nested balls $D_1^k \subseteq D_2^k \subseteq D_3^k \subseteq B^k$, such that $D_i^k \subseteq D_{i+1}^k$ for each i and $B^k \setminus D_1^k \subseteq C_1$. Choose closed, nested balls $D_1^n \subseteq D_2^n \subseteq D_3^n \subseteq T^n \setminus 2B^n$,

As in the proof of Theorem 15.4 in Section 15.2 we will construct the following tower of maps.

$$\begin{array}{ccc}
 B^k \times \mathbb{R}^n & \xleftarrow[\cong]{\tilde{h}} & B^k \times \mathbb{R}^n \\
 \uparrow & & \uparrow \\
 3B^k \times 3B^n & \xrightarrow{\tilde{h}} & \mathbb{R}^k \times \mathbb{R}^n \\
 \gamma \downarrow & & \downarrow \gamma \\
 B^k \times \mathbb{R}^n & \xleftarrow[\cong]{\tilde{h}} & B^k \times \mathbb{R}^n \\
 \text{Id} \times e \downarrow & & \downarrow \text{Id} \times e \\
 B^k \times T^n & \xleftarrow[\cong]{\tilde{h}} & B^k \times T^n \\
 \uparrow & & \uparrow \\
 (B^k \times T^n) \setminus (D_3^k \times D_3^n) & \xleftarrow[\cong]{\tilde{h}|} & (B^k \times T^n) \setminus (D_1^k \times D_1^n) \\
 \downarrow & & \downarrow \\
 (B^k \times T^n) \setminus (D_2^k \times D_2^n) & \xleftarrow[\cong]{\tilde{h}} & (B^k \times T^n) \setminus (D_1^k \times D_1^n) \\
 \uparrow & & \uparrow \\
 B^k \times (T^n \setminus D_2^n) & \xleftarrow[\cong]{\tilde{h}} & B^k \times (T^n \setminus D_1^n) \\
 \text{Id} \times \alpha_0 \uparrow & & \uparrow \text{Id} \times \alpha_0 \\
 B^k \times 4B^n & \xleftarrow[h]{} & B^k \times \mathbb{R}^n
 \end{array}$$

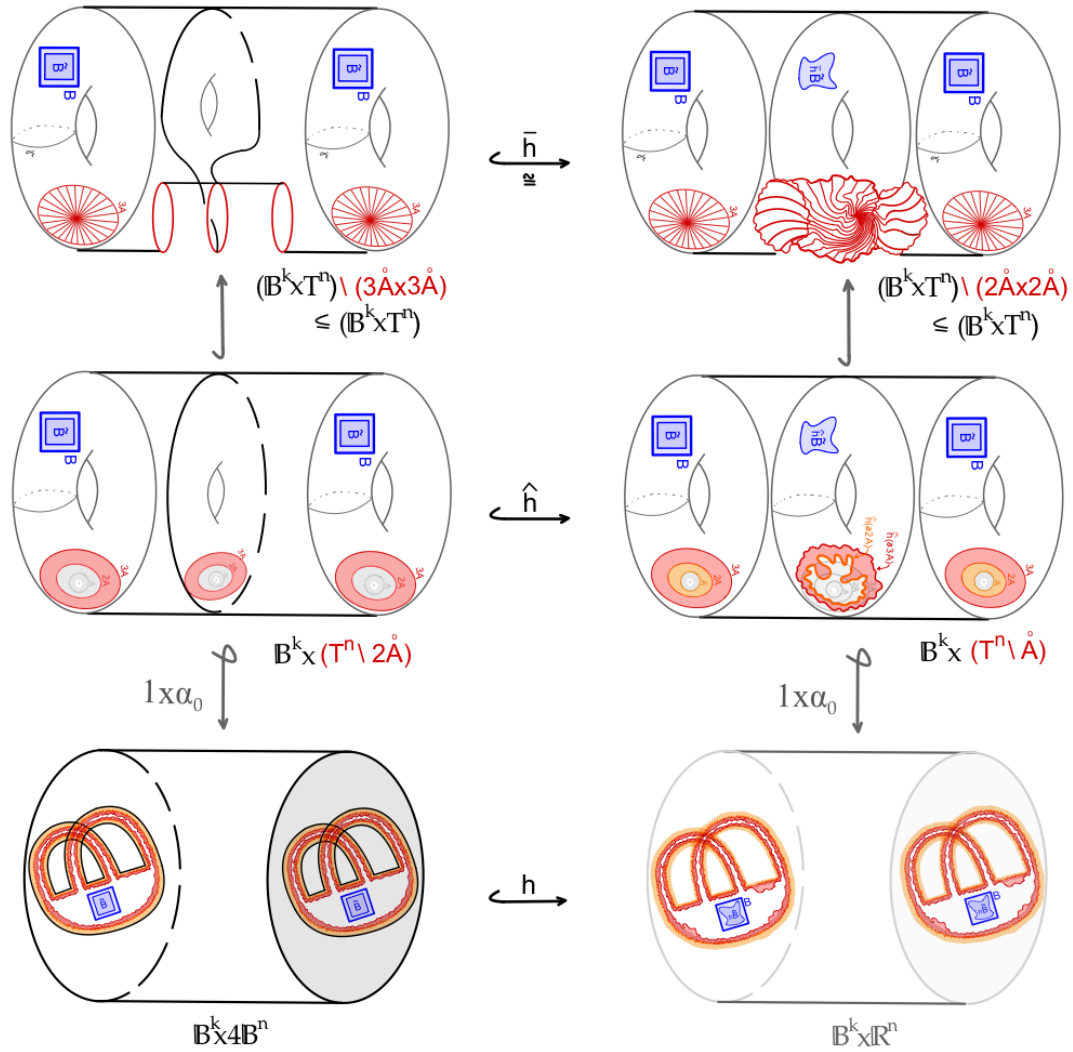

FIGURE 19.3. The torus trick for handle straightening.

See Fig. 19.3 for a schematic version.

We start with an immersed torus $\alpha_0: T^n \setminus D_1^n \looparrowright \text{Int}(3B^n)$ with $\alpha_0|_{2B^n} = \text{Id}$. Then define the map $\alpha := \text{Id} \times \alpha_0: B^k \times (T^n \setminus D_2^n) \rightarrow B^k \times 4B^n$. We choose Q so that it is possible to construct the lift \hat{h} . This is quite similar to the proof of Theorem 15.4 so we skip the details. Briefly, the map \hat{h} is defined to agree with $\alpha^{-1} \circ h \circ \alpha$ on small neighbourhoods. The set Q is chosen small enough so that the image of $B^k \times (T^n \setminus D_2^n)$ under \hat{h} lies within $B^k \times (T^n \setminus D_1^n)$.

Observe that $\hat{h}|_{(B^k \setminus D^k) \times (T^n \setminus D_2^n)} = \text{Id}$, since h agrees with the inclusion map on $C := C_1 \times 3B^n$, and by construction we have $\alpha(T^n \setminus D_2^n) \subseteq \text{Int } 3B^n$ and $B^k \setminus D^k \subseteq C_1$. Thus we can extend \hat{h} by the identity to obtain the map in the third row of the diagram from the bottom. In Proposition 15.7, we showed a version of the Schoenflies theorem for the torus. There is also a version for $B^k \times T^n$, which can be made canonical. Applying this, followed by the Alexander coning trick, we obtain the homeomorphism \bar{h} in the next row in the diagram. More precisely, we first consider the restriction of \hat{h} to $(B^k \times T^n) \setminus (D_3^k \times D_3^n)$, and observe that the image of $\partial(D_3^k \times D_3^n)$ is a bicollared sphere in $B^k \times T^n$, and therefore bounds a ball in $B^k \times T^n$. Extending the map over this ball in the codomain and the ball $D_3^k \times D_3^n$ in the domain produces the

homeomorphism

$$\bar{h}: B^k \times T^n \xrightarrow{\cong} B^k \times T^n.$$

By choosing Q to be small enough, we may assume that \bar{h} is homotopic to $\text{Id}_{B^k \times T^n}$ (see Step 9 of Section 15.2), so that its lift \check{h} to universal covers is bounded distance from Id (see Proposition 15.2). As in the proof of Theorem 15.4, we choose the covering map e so that $B^k \times 2B^n$ is mapped by the identity.

Recall that our goal is to define a homeomorphism $\tilde{h}: B^k \times \mathbb{R}^n \rightarrow B^k \times \mathbb{R}^n$ which restricts to the identity outside a compact set. While \check{h} is a homeomorphism of $B^k \times \mathbb{R}^n$, it cannot be our desired map, since being obtained as a lift to a covering space, if it were to restrict to the identity outside a compact set, it would equal the identity map everywhere. In the next (and final) step of the construction of \tilde{h} we will modify \check{h} to arrange for the desired behaviour. Roughly speaking, we will rescale so that all the nontrivial behaviour of \check{h} is concentrated in a compact region in such a way that we can extend by the identity everywhere else. The strategy is similar to the proof of Proposition 17.13.

Observe that $\check{h}|_{\partial B^k \times \mathbb{R}^n} = \text{Id}$ since $h|_C$ coincides with the inclusion map and $\alpha_0(T^n \setminus D_1^n) \subseteq 3B^n$. So we can extend \check{h} by the identity to get a map $\check{h}: \mathbb{R}^k \times \mathbb{R}^n \rightarrow \mathbb{R}^k \times \mathbb{R}^n$.

Define $\gamma: \text{Int}(3B^k \times 3B^n) \xrightarrow{\cong} \mathbb{R}^n$ as a radial expansion fixed on $2B^k \times 2B^n$. Then define

$$\tilde{h}: B^k \times \mathbb{R}^n \rightarrow B^k \times \mathbb{R}^n \text{ as } \begin{cases} \gamma^{-1}\check{h}\gamma, & \text{on } B^k \times 3B^n, \\ \text{Id}, & \text{on } B^k \times (\mathbb{R}^n \setminus \text{Int}(3B^n)). \end{cases}$$

The above map is continuous since \check{h} is bounded distance from the identity. The homeomorphism \tilde{h} agrees with h on $B^k \times B^n$, by our definition of γ and α . It also satisfies $\tilde{h}|_{\partial B^k \times \mathbb{R}^n \cup B^k \times (\mathbb{R}^n \setminus \text{Int}(3B^n))} = \text{Id}$. To see this, first we note that $\tilde{h}|_{B^k \times (\mathbb{R}^n \setminus \text{Int}(3B^n))}$ by explicit construction. We know that $\tilde{h}|_{\partial B^k \times \mathbb{R}^n} = \text{Id}$ since $\check{h}|_{\partial B^k \times \mathbb{R}^n} = \text{Id}$. Each step in the construction has been canonical, so \tilde{h} depends continuously on h , and from our construction we note that for $h = \eta$ we have $\tilde{h} = \text{Id}$. This finishes the construction of \tilde{h} .

To finish off the proof of the lemma, extend \tilde{h} by the identity map to get $\tilde{h}: B^k \times \mathbb{R}^n \rightarrow B^k \times \mathbb{R}^n$, which depends continuously on h (see Step 7 of Section 15.2).

Define the isotopy

$$\tilde{H}_t: B^k \times \mathbb{R}^n \rightarrow B^k \times \mathbb{R}^n \text{ by } \begin{cases} t\tilde{h}(\frac{1}{t}x) & t > 0 \\ x & t = 0 \end{cases}$$

(compare Proposition 15.3) taking the identity to \tilde{h} . Define

$$\Psi(h, t) := \tilde{H}_t^{-1} \circ h: B^k \times 4B^n \rightarrow B^k \times \mathbb{R}^n$$

so that $\Psi(h, 0) = \tilde{H}_0^{-1}h = \text{Id}^{-1}h = h$ and $\Psi(h, 1) = \tilde{H}_1^{-1}h = \tilde{h}^{-1}h$, as desired.

We finally check that this isotopy has all the desired properties. By choosing Q small enough we arrange that $h(B^k \times \partial 4B^n) \cap B^k \times 3B^n = \emptyset$. Then since H_t restricts to the identity on $B^k \times (\mathbb{R}^n \setminus \text{Int}(3B^n))$, we see that Ψ is modulo $\partial(B^k \times 4B^n)$. Since h and \tilde{h} agree on $B^k \times B^n$, we see that $\Psi(h, 1)|_{B^k \times B^n} = \tilde{h}^{-1}h|_{B^k \times B^n}$ is the inclusion, so indeed Ψ gives a deformation of Q into $\text{Emb}_{\partial B^k \times 4B^n \cup B^k \times B^n}(B^k \times 4B^n, B^k \times \mathbb{R}^n)$. The map $\Psi: Q \times [0, 1] \rightarrow \text{Emb}_{\partial B^k \times 4B^n}(B^k \times 4B^n, B^k \times \mathbb{R}^n)$ is continuous since our construction has been canonical throughout. Finally, one should check that $\Psi(\eta, t) = \eta$ for all t . \square

19.2. Applying handle straightening

The following theorem generalises the last lemma to “straightening a compact set” in a manifold.

THEOREM 19.8 ([EK71a, Theorem 5.1]). *Let M be a manifold and $C \subseteq U \subseteq M$ where U is an open neighbourhood of the compact set C . Then there exists a neighbourhood P of the inclusion $\eta: U \hookrightarrow M$ and a deformation*

$$\phi: P \times [0, 1] \rightarrow \text{Emb}(U, M)$$

into $\text{Emb}_C(U, M)$ modulo the complement of a compact neighbourhood of C in U , and fixing η .

Using this we easily prove Theorem 19.1, i.e. that $\text{Homeo}(M)$ for a compact manifold M is locally contractible.

Proof of Theorem 19.1. Set $C := U := M$, and note $\text{Emb}(M, M) = \text{Homeo}(M)$ (as embeddings are always proper in this section) and $\text{Emb}_M(M, M) = \{\text{Id}_M\}$. Then apply Theorem 19.8. \square

Sketch proof of Theorem 19.8. Assume $\partial M = \emptyset$ for simplicity. (The case of nonempty boundary can be reduced to this case by using a boundary collar. See [EK71a] for more details.) Let $\{h_i: W_i \xrightarrow{\cong} \mathbb{R}^n\}_{1 \leq i \leq r}$ be a finite cover of C by Euclidean neighbourhoods, with $W_i \subseteq U$ for each i . Such a cover exists since C is compact and M is a manifold. Write $C = \bigcup_{i=1}^r C_i$ where each $C_i \subseteq W_i$ is compact, and define $D_i := \bigcup_{j \leq i} C_j$ for $1 \leq i \leq r$ (see Fig. 19.4).

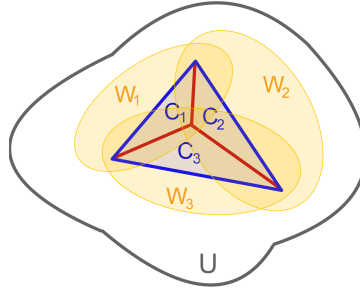

FIGURE 19.4. Proof of Theorem 19.8

We will induct on $i \geq 0$ and prove that for every $i \geq 0$, there exists a neighbourhood P_i of $\eta: U \hookrightarrow M$ in $\text{Emb}(U, M)$ and a deformation $\phi_i: P_i \times [0, 1] \rightarrow \text{Emb}(U, M)$ into $\text{Emb}_{U \cap V_i}(U, M)$ where V_i is some neighbourhood of D_i . (We are focussing on building the deformation rather than the “modulo” or “fixing” portions of the conclusion.)

For the base case $i = 0$, we just take $P_0 = \text{Emb}(U, M)$ and $\phi_0 = \text{Id}$. Now assume the inductive hypothesis for some $i \geq 0$. To prove the $i + 1$ case, identify W_{i+1} with \mathbb{R}^m (using the map h_{i+1}) for convenience. That is, we have $C_{i+1} \subseteq \mathbb{R}^m$ compact, and $V_i \cap \mathbb{R}^m$ is a neighbourhood in \mathbb{R}^m of the closed set $D_i \cap \mathbb{R}^m$.

Let N be a compact neighbourhood of $C_{i+1} \cap D_i$ in $\text{Int}(V_i \cap \mathbb{R}^m)$. Choose a (small) triangulation of $\mathbb{R}^m (= W_{i+1})$. Define K to be the subcomplex of this triangulation consisting of all the simplices that intersect $C_{i+1} \cup N$. Let L be the subcomplex consisting of all the simplices that intersect N . Then we obtain a handle decomposition of K relative to L as explained in Section 13.3. Observe that we have the following properties:

- (1) $D_i \cap C_{i+1} \subseteq L \subseteq \text{Int}(V_i \cap \mathbb{R}^m)$
- (2) $\overline{C_{i+1}} \subseteq K$
- (3) $K \setminus L \cap D_i = \emptyset$
- (4) If A is a handle of $K \setminus L$ with index k , there exists an embedding $\mu: B^k \times \mathbb{R}^n \hookrightarrow \mathbb{R}^m$, where $m = k + n$, such that $\mu(B^k \times B^n) = A$ and $\mu(B^k \times \mathbb{R}^n) \cap (D_i \cup L \cup K^k \setminus A) = \mu(\partial B^k \times B^n)$ where K^k is the k -skeleton of K .

Let $A_1, \dots, A_j, \dots, A_s$ be the handles of $K \setminus L$ of non-decreasing index. Now we will induct on j . This will finally enable us to apply handle straightening (Lemma 19.7) to each A_j .

Specifically, for each $j \geq 0$, define $D'_j := D_i \cup L \cup \bigcup_{\ell \leq j} A_j$. We will prove that for each $j \geq 1$ there exists a neighbourhood P'_j of the inclusion $\eta: U \hookrightarrow M$ in $\text{Emb}(U, M)$ and a deformation $\phi'_j: P'_j \times [0, 1] \rightarrow \text{Emb}(U, M)$ into $\text{Emb}_{U \cap V'_j}(U, M)$ where V'_j is some neighbourhood of D'_j in M . The base case $j = 0$ is satisfied the hypothesis in the bigger induction proof. Now assuming the case for some j , we prove the $j + 1$ case.

We know that for A_{j+1} there is a corresponding map $\mu: B^k \times \mathbb{R}^n \hookrightarrow \mathbb{R}^m$. Reparametrise in the \mathbb{R}^n coordinate, fixing B^n so that $\mu(B^k \times 4B^n) \subseteq \text{Int}(V'_j)$.

Now by handle straightening (Lemma 19.7), we know that there is some neighbourhood Q of the inclusion $\eta_0: B^k \times 4B^n \hookrightarrow B^k \times \mathbb{R}^n$ in $\text{Emb}_{\partial B^k \times 4B^n}(B^k \times 4B^n, B^k \times \mathbb{R}^n)$ and a deformation ψ of Q into $\text{Emb}_{\partial B^k \times 4B^n \cup B^k \times 2B^n}(B^k \times 4B^n, B^k \times \mathbb{R}^n)$, modulo $\partial(B^k \times 4B^n)$ and fixing η_0 . Let Q' be a neighbourhood of the inclusion $\eta: U \hookrightarrow M$ in $\text{Emb}_{U \cap V'_j}(U, M)$ such that if $h \in Q'$ then $h \circ \mu(B^k \times 4B^n) \subseteq \mu(B^k \times \mathbb{R}^n)$ and $\mu^{-1}h\mu|_{B^k \times 4B^n} \in Q$.

Next we will use ψ to define V'_{j+1} and deform Q' . For $h \in Q'$, define

$$h_t := \begin{cases} h & \text{on } U \setminus \mu(B^k \times 4B^n) \\ \mu\psi(\mu^{-1}h\mu, t)\mu^{-1} & \text{on } \mu(B^k \times 4B^n) \end{cases}$$

Define $V'_{j+1} := (V'_j \cup \mu(B^k \times 2B^n)) \setminus \mu(B^k \times [2, 4]B^n)$. Then $h_0 = h$ and $h_1 \in \text{Emb}_{U \cap V'_{j+1}}(U, M)$. Define $\psi'(h, t) := h_t$, a deformation a of Q' . By the continuity of ϕ'_j , there exists a neighbourhood P'_{j+1} of η in $\text{Emb}(U, M)$ so that $P'_{j+1} \subseteq P'_j$ and $\phi'_j(P'_{j+1} \times 1) \subseteq Q'$. Define the deformation ϕ'_{j+1} to be the result of performing the deformations ψ' and $\phi'_j|_{P'_{j+1} \times [0, 1]}$ in order. This completes the induction on j , which completes in turn the induction on i . This completes the proof (sketch). \square

19.3. Proof of the isotopy extension theorem

We recall the statement of the isotopy extension theorem.

THEOREM 19.9 (Isotopy extension theorem [EK71a, Corollary 1.2, Corollary 1.4]).

- (1) Let $h_t: C \rightarrow M$, $t \in [0, 1]$ be a proper isotopy of a compact set $C \subseteq M$, such that h_t extends to a proper isotopy of a neighborhood $U \supseteq C$. Then h_t can be covered by an (ambient) isotopy, that is, there exists $H_t: M \rightarrow M$, satisfying $H_0 = \text{Id}_M$ and $h_t = H_t \circ h_0$ for all $t \in [0, 1]$.
- (2) For manifolds M and N with N compact, any locally flat proper isotopy $h_t: N \rightarrow M$ is covered by an ambient isotopy. If $h_t = h_0$ for all t on a neighbourhood of ∂N , then we may assume that $H_t|_{\partial M} = \text{Id}_{\partial M}$.

In both cases, we may assume that H has compact support, that is, $H_t = \text{Id}_M$ outside some compact set, for each t .

Proof. We prove the first part of the theorem. The plan is to construct H_t in small steps. Choose a compact neighbourhood V of C satisfying $C \subseteq V \subsetneq U$. Let h_t denote the extended isotopy $h_t: U \hookrightarrow M$. Such an extension exists by hypothesis.

Fix $T \in [0, 1]$. By Theorem 19.8 we know there exists a neighbourhood P of the inclusion $\eta: h_T(U) \hookrightarrow M$ and a deformation $\phi: P \times [0, 1] \rightarrow \text{Emb}(h_T(U), M)$ into $\text{Emb}_{h_T(C)}(h_T(U), M)$ modulo $h_T(U \setminus V)$.

Let $N(T) \subseteq [0, 1]$ denote a neighbourhood of $T \in [0, 1]$ such that the composite

$$h_T(U) \xrightarrow{h_T^{-1}} U \xrightarrow{h_t} M$$

is in P for all $t \in N(T)$. Observe that $h_t \circ h_T^{-1} \in \text{Emb}(h_T(U), M)$. Define

$$(H_T)_t: M \xrightarrow{\cong} M$$

$$x \mapsto \begin{cases} h_t \circ h_T^{-1} \left(\Phi(h_t \circ h_T^{-1}, 1) \right)^{-1}(x), & x \in h_T(U), \\ x, & x \in M \setminus h_T(U). \end{cases}$$

We need to check that the above is a continuous function. Recall that ϕ is modulo $h_T(U \setminus V)$, so for $x \in h_T(U \setminus V)$ we have $\phi(h_t \circ h_T^{-1}, 1)(x) = h_t \circ h_T^{-1}(x)$, so $(H_T)_t(x) = x$, showing that the two definitions match up. For continuity we also need to observe that Φ is continuous with respect to t , since the argument changes as t changes.

Next we check that H_T covers h_T locally. Since $\phi(h_t \circ h_T^{-1}, 1) \in \text{Emb}_{h_T(C)}(h_T(U), M)$, we know that for $x \in h_T(C)$ we get $\phi(h_t \circ h_T^{-1}, 1)^{-1}(x) = x$. Thus, $(H_T)_t \circ h_T(y) = h_t \circ h_T^{-1} \circ h_T(y) = h_t(y)$, that is, $(H_T)_t \circ h_T|_C = h_t|_C$ for $t \in N(T)$.

We now use compactness of the interval $[0, 1]$ to choose a finite partition $0 = t_0 < t_1 < \dots < t_n = 1$. By the above argument, we have ambient isotopies $H_{i,t}: M \rightarrow M$ with $t \in [t_i, t_{i+1}]$ such that $h_t|_C = H_{i,t} \circ h_{t_i}|_C$ for all $t \in [t_i, t_{i+1}]$.

In order to build the desired ambient isotopy H_t out of these local isotopies, we induct on $i \geq 0$. For $i = 0$ we have $H_0 = \text{Id}_M$. Assume inductively that we have constructed $H_i: M \xrightarrow{\cong} M$ with $t \in [0, t_i]$ such that $H_t \circ h_0|_C = h_t|_C$ for all $t \in [0, t_i]$ and $H_0 = \text{Id}_M$.

We define H_t on $[t_i, t_{i+1}]$ by setting

$$H_t(x) = H_{i,t} \circ H_{i,t_i}^{-1} \circ H_{t_i} \text{ for } [t_i, t_{i+1}]$$

At $t = t_i$, we see that $H_{i,t_i} \circ H_{i,t_i}^{-1} \circ H_{t_i} = H_{t_i}$, so we have a well-defined map on $M \times [0, t_{i+1}]$. Additionally, we see that for $x \in C$ and $t \in [t_i, t_{i+1}]$,

$$\begin{aligned} H_t \circ h_0(x) &= H_{i,t} \circ H_{i,t_i}^{-1} \circ H_{t_i} \circ h_0(x) \\ &= H_{i,t} \circ H_{i,t_i}^{-1} \circ h_{t_i}(x) \\ &= H_{i,t} \circ h_{t_i}(x) \\ &= h_t(x) \end{aligned}$$

where we have used that $h_t|_C = H_{i,t} \circ h_{t_i}|_C$ for $t \in [t_i, t_{i+1}]$ and $H_{t_i} \circ h_0|_C = h_{t_i}|_C$.

For part b) of Theorem 19.4, we only have locally flat neighbourhoods (instead of a global neighbourhood U from part a)). The proof consists of applying part(a) in each local neighbourhood, and then gluing together these local isotopies, as above, to produce the desired ambient isotopy. For more details, we refer the reader to [EK71a, Proof of Corollary 1.4]. \square

EXERCISE 19.1. (PS10.1) Prove the "strong Palais theorem". That is, let $n \geq 6$, let M be a connected oriented n -manifold and let $\phi, \psi: D^n \rightarrow M$ be locally collared embeddings with the same orientation-behaviour. Then there exists an isotopy $H_t: M \rightarrow M$ satisfying $H_0 = \text{Id}$, and $H_1 \circ \phi = \psi$.

EXERCISE 19.2. (PS10.2) Let M be a compact manifold. Prove that $\text{Homeo}(\text{Int}(M))$ is locally contractible. Recall that we saw earlier that the homeomorphism group of a noncompact manifold need not be locally contractible. The above gives an alternative proof that $\text{Homeo}(\mathbb{R}^n)$ is locally contractible.

Hint: Let C be the compact manifold formed by removing an open collar of the boundary of M . Argue that a neighbourhood of the identity map in $\text{Homeo}(\text{Int}(M))$ can be deformed into $\text{Homeo}_C(M)$, consisting of the homeomorphisms of M which restrict to the identity on C . Now deform $\text{Homeo}_C(M)$ to $\{\text{Id}\}$ using the collar.

Fix an orientation on S^m for every m . Let $f: S^n \rightarrow S^{n+2}$ be a locally flat embedding. We call $K := f(S^n)$ an n -knot. If S^n and S^{n+2} have their standard smooth structures, and if f is a smooth embedding, then we call K a smooth n -knot.

EXERCISE 19.3. (PS11.1) For $n \geq 5$, show that the embeddings f and g defining two n -knots $K = f(S^n)$ and $J = g(S^n)$ are locally-flat isotopic if and only if there is an orientation preserving homeomorphism $F: S^{n+2} \rightarrow S^{n+2}$ such that $F(K) = J$, and $F|_K: K \rightarrow J$ is orientation preserving, with respect to the orientations induced by f and g .

Hint: You may use the isotopy extension theorem, as well as SH_m and its consequences. (The same holds for all $n \geq 1$, but we do not have the tools to prove it from the course.)

EXERCISE 19.4. (PS11.2) For $n \geq 1$, show that the embeddings f and g defining two smooth n -knots $K = f(S^n)$ and $J = g(S^n)$ are smoothly isotopic if and only if there is an orientation preserving diffeomorphism $F: S^{n+2} \rightarrow S^{n+2}$ such that $F(K) = J$ and $g^{-1} \circ F \circ f: S^n \rightarrow S^n$ is smoothly isotopic to the identity.

You may use the smooth version of the isotopy extension theorem. The theorems from the course may not be very helpful.

Counting topological manifolds

Magdalena von Wunsch

Introduction

The goal of this text is to prove a theorem by Cheeger and Kister stating that there are countably many compact topological manifolds. We will first look at precise classification theorems of compact manifolds in low dimensions, then at special cases of the statement for smooth and high-dimensional manifolds, and finally show the proof given by Cheeger and Kister in [CK70]. At the end, we will present an application to topological Morse theory discussed in that same paper.

20.1. Classifications of compact manifolds

It is sufficient to classify all compact connected manifolds of a given dimension to classify the compact manifolds. As a compact manifold can only have finitely many components, countability of the set of compact connected manifolds then automatically implies countability of the set of all compact manifolds, as those are exactly the finite disjoint unions of the connected compact manifolds.

- **0-manifolds.** There is only one compact connected 0-manifold, namely the point, and a 0-manifold cannot have nonempty boundary. So the set of all compact 0-manifolds up to homeomorphism is countable.
- **1-manifolds.** There is, up to homeomorphism, exactly one compact connected 1-manifold without boundary, namely the circle S^1 , and one compact connected 1-manifold with nonempty boundary, namely the closed unit interval $I = [0, 1]$. A proof can be found in [FR84]. Thus the set of all compact 1-manifolds up to homeomorphism is countable.
- **2-manifolds.** Orientable connected compact 2-manifolds with empty boundary can be obtained as finite connected sums of 2-tori, the number of tori being referred to as the *genus* of the manifold. The empty connected sum is defined as the sphere S^2 . Non-orientable connected compact 2-manifolds with empty boundary are finite connected sums of $\mathbb{R}P^2$ and the number of $\mathbb{R}P^2$ s in the connected sum is called the genus. As any compact 1-manifold without boundary is homeomorphic to a finite union of circles, compact 2-manifolds with nonempty boundary are obtained from compact 2-manifolds with empty boundary by removing finitely many disjoint disks. A detailed proof can be found in [Moi77, Chapter 22]. So, up to homeomorphism, compact connected 2-manifolds can be classified by orientability, genus and number of boundary components, the last two being integers, and thus the set of all compact 2-manifolds up to homeomorphism is countable.

For higher dimension, classification results are far more difficult and not as complete. There has been a lot of progress in the classification of compact 3-manifolds, especially around the Thurston geometrization conjecture first stated in 1982 in [Thu82]. The conjecture was proved in 2003 using Ricci flow by Perelman in [Per03c] (a brief discussion of these developments can be found in [Mil03]).

20.2. Smooth case

THEOREM 20.1. *There are only countably many compact smooth manifolds, up to homeomorphism.*

Proof. As all compact smooth manifolds have a finite triangulation (as shown in [Cai61]), there can only be countably many compact smooth manifolds up to homeomorphism: every compact smooth manifold M can be constructed inductively in k steps by gluing a simplex to the existing structure in each step, where k is the number of simplices in the finite triangulation of M . In each step, there are only finitely many possible edges of simplices the new simplex can be glued to, so there are only countably many possibilities to construct a compact smooth manifold. \square

We know that topological manifolds that admit smooth structures can have multiple smooth structures that are not diffeomorphic to each other, one well-known example being Milnor's exotic sphere (see [Mil56]). Thus, this proof can only classify compact smooth manifolds up to homeomorphism, as the simplices can have multiple non-diffeomorphic smooth structures, and the gluing maps need not preserve the smooth structure. So the question can be extended to ask whether there are countably many diffeomorphism types of smooth manifolds.

In dimensions up to three, topological and smooth manifolds coincide, i.e. every topological 3-manifold has exactly one smooth structure (up to diffeomorphism). A proof of this for dimension one can be found in the appendix of Milnor's book on differentiable topology ([Mil97b, Appendix]), a proof for dimension two is given by Radó in [Rad24] and a proof for dimension three can be found in [Moi52a].

Compact manifolds of dimension strictly greater than four only admit finitely many pairwise non-diffeomorphic structures on the same manifold. This follows from the facts that PL-able compact topological manifolds of dimension $n \geq 5$ only admit finitely many PL structures (this is a result by Kirby and Siebenmann that can be found in the lecture notes as Remark 17.12), and compact PL manifolds only admit a finite number of smoothings (see chapter 18 in the lecture notes).

This leaves only dimension four to be considered, which as usual behaves a bit differently than other dimensions. There are non-compact 4-manifolds that admit uncountably many pairwise non-diffeomorphic smooth structures (the most famous example being \mathbb{R}^4 , as shown in [DMF92]). However, compact 4-manifolds thankfully only admit countably infinitely many pairwise non-diffeomorphic smooth structures because the PL and DIFF categories coincide for dimension four, i.e. every PL 4-manifold has exactly one smooth structure up to diffeomorphism (see Theorem 18.3 in the lecture notes). By a combinatorial argument, there can only be countably many PL structures on a compact manifold. We know concrete examples of 4-manifolds that admit countably infinitely many non-isomorphic smooth structures, for example the $K3$ -surface that was discussed in a previous talk. The proof that there are infinitely many exotic smooth structures on the $K3$ -surface is due to work by Donaldson, Gompf and Mrowka in [Don90] and [GM93].

Still, as there are only countably many compact smooth 4-manifolds up to homeomorphism, and each of these manifolds can only have countably many pairwise non-diffeomorphic smooth structures, there are also only countably many compact smooth 4-manifolds up to diffeomorphism.

20.3. High-dimensional case

THEOREM 20.2. *There are only countably many closed topological manifolds of dimension $n \geq 6$ up to homeomorphism.*

We will only give an idea for a proof of this theorem. Using the handlebody theory for topological manifolds developed by Kirby and Siebenmann discussed in the lecture notes (Theorem 21.4), we know that closed topological manifolds of dimension $n \geq 6$ have a handle decomposition. This handle decomposition must be finite, as the manifold is compact: since the

handles are compact, we can choose a covering of M by covering every handle with finitely many sets, and choose this covering in such a way that every open set in the covering covers at most one handle. As the manifold is compact, this covering has a finite subcovering, so there can only be finitely many handles. Similarly to Theorem 20.1 we can then construct every closed topological manifold of dimension $n \geq 6$ inductively in finitely many steps by gluing handles together. Up to homeomorphism, there are only countably many options of gluing a handle on, so there are only countably many possibilities to construct a closed manifold of dimension $n \geq 6$.

This proof can be extended to 5-manifolds using the work of Quinn, who showed in [Qui82b] that 5-manifolds have topological handle decompositions.

20.4. Cheeger-Kister's proof

The main result of this part is the following theorem proved by Cheeger and Kister in [CK70].

THEOREM 20.3. *Up to homeomorphism, there are only countably many compact topological manifolds (with possibly nonempty boundary).*

Although the statement of the theorem can be proven for many special cases (low dimensions, high dimensions, PL-able topological manifolds) as we discussed above, the statement of Theorem 20.3 is still an improvement, as we have seen that non-PL-able manifolds exist. A big advantage of the proof we will present is also that it works the same way for all dimensions.

To prepare for the proof, we state and prove the following useful facts about separable spaces.

Definition 20.4. A space X is called *separable* if there is a countable subset S of X that is dense in X .

LEMMA 20.5. *Subspaces of separable metric spaces are separable.*

Proof. Let X be a separable metric space with a countable dense subset S and $Y \subseteq X$, and let d be the metric on X . We consider the distance $d(s, Y) := \inf\{d(s, y) \mid y \in Y\}$ for all $s \in S$. For every $s \in S$, find a sequence of points a_n^s in Y with $d(s, a_n^s) < d(s, Y) + \frac{1}{n}$.

We define the set $A := \{a_n^s \in Y \mid s \in S, n \in \mathbb{N}\}$. This set is a countable subset of Y because S is countable. It is also dense in Y because for any $y \in Y$ and $\varepsilon > 0$, we can find some $s \in S$ with $d(s, y) < \frac{\varepsilon}{3}$, because S is dense in X , and this implies $d(s, Y) \leq \frac{\varepsilon}{3}$. So there is some $a_n^s \in A$ with $d(s, a_n^s) < d(s, Y) + \frac{1}{n} < d(s, Y) + \frac{\varepsilon}{3} \leq \frac{2\varepsilon}{3}$, by choosing n big enough so that $\frac{1}{n} < \frac{\varepsilon}{3}$, and thus for this a_n^s we get $d(y, a_n^s) \leq d(s, y) + d(s, a_n^s) < \varepsilon$, so A is dense in Y and so Y is separable. \square

LEMMA 20.6. *If X is an uncountable separable metric space, there exists some $x \in X$ that is the limit point of a sequence $x_1, x_2, \dots \in X$ with $x_i \neq x$ for all $i \in \mathbb{N}$.*

Proof. Let X be an uncountable separable metric space. Assume there is no such point in X . Then we can find, for every $x \in X$, an open ball $B_{\varepsilon_x}(x) \subseteq X$ that contains only x . As X is uncountable, we can choose some $\varepsilon > 0$ such that there are uncountably many $x \in X$ with $\varepsilon_x > \varepsilon$ by observing the sets $X_n := \{x \in X \mid \varepsilon_x > \frac{1}{n}\}$. As X is uncountable and \mathbb{N} is countable, there must be some $n \in \mathbb{N}$ with X_n uncountable, and we set $\varepsilon = \frac{1}{n}$.

We set $X' := X_n = \{x \in X \mid \varepsilon_x > \varepsilon\}$ and consider the smaller open balls $B_\varepsilon(x)$ for $x \in X'$. These are disjoint, as $B_\varepsilon(x)$ contains only x and there are uncountably many of them since X' is uncountable. But this is a contradiction to the separability of X , as all dense subsets of X must contain at least one element in each $B_\varepsilon(x)$. \square

For the proof of Theorem 20.3 we first restrict to the case of manifolds with empty boundary.

THEOREM 20.7. *Up to homeomorphism, there are only countably many compact topological manifolds with empty boundary.*

Proof. The proof of the theorem will be by contradiction, so we first assume that there are uncountably many compact manifolds with empty boundary that are pairwise non-homeomorphic. Then, there must be some dimension n such that there are uncountably many n -manifolds (as there are only countably many options for n). We choose such an n and fix it for the rest of the proof. Throughout the rest of the text, $B_r(x)$ will denote the closed ball of radius r centered at x in \mathbb{R}^n . For this n , we denote the collection of all homeomorphism types of compact n -manifolds by $\mathcal{M} = \{M_\alpha\}_{\alpha \in \mathcal{A}}$, where \mathcal{A} is uncountable.

For each manifold M_α in \mathcal{M} , choose finitely many embeddings of $B_2(0)$ into M such that M_α is covered by the images of the restrictions to $B_1(0)$, i.e. we choose embeddings $h_{\alpha_j} : B_2(0) \rightarrow M_\alpha$ so that $\{h_{\alpha_j}|_{B_1(0)}\}_{j=1}^{k_\alpha}$ covers M_α . Such a covering can be constructed by covering M_α with open balls $h_{\alpha_x}(B_2(0))$ around each point x in M_α , as the manifold is locally euclidean, and restricting to the images of $B_1(0)$. Since M is a compact manifold, there exists a finite subcovering of this collection that still covers M_α , and the embeddings of this subcovering, extended to the closed balls of radius 2, meet the condition.

We then choose a k such that there are uncountably many n -manifolds in \mathcal{M} with $k_\alpha = k$. This choice is possible by the same argument as for the choice of n . By an abuse of notation, we also denote this new uncountable collection of manifolds with $k_\alpha = k$ by \mathcal{M} . We then modify the maps h_{α_j} by fixing them on $B_1(0)$ and reparametrizing such that $h_{\alpha_j}|_{B_1(0)}$ is extended to an embedding of $B_{k+1}(0)$ with the same image as h_{α_j} , and continue referring to this modified embedding as h_{α_j} , i.e. we now have embeddings $h_{\alpha_j} : B_{k+1}(0) \rightarrow M_\alpha$ for $1 \leq j \leq k$ and $M_\alpha \in \mathcal{M}$.

Every n -manifold M_α can be embedded in \mathbb{R}^{2n+1} , as we have seen in a previous talk (the result is due to Hanner [Han51b]). We set $l := 2n + 1$ and fix an embedding of M_α into \mathbb{R}^l for all $\alpha \in \mathcal{A}$. We assume henceforth that $M_\alpha \subseteq \mathbb{R}^l$ for all $M_\alpha \in \mathcal{M}$.

Let d be the standard metric in \mathbb{R}^l and define

$$\varepsilon_{\alpha,j,m} := d(h_{\alpha_j}(B_m(0)), M_\alpha \setminus h_{\alpha_j}(B_{m+1}(0))) \quad \forall \alpha \in \mathcal{A}, j, m \in \{1, \dots, k\}.$$

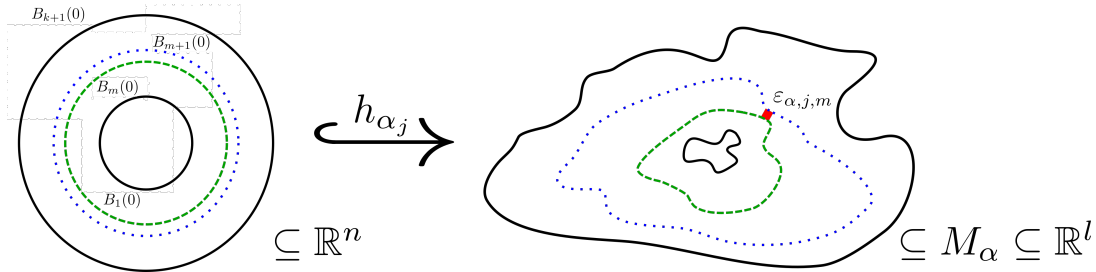

FIGURE 20.1. This figure shows the intuition behind the definition of $\varepsilon_{\alpha,j,m}$.

We then define $\varepsilon_\alpha := \min_{j,m} \{\varepsilon_{\alpha,j,m}\}$. This minimum is well-defined because $j \in \{1, \dots, k\}$ and $m \leq k$.

We then choose an uncountable subcollection of \mathcal{M} so that there exists some $\varepsilon > 0$ such that $\varepsilon_\alpha > \varepsilon$ for all manifolds in this subcollection. This new subcollection, which we will continue denoting by \mathcal{M} , can be chosen by defining $\mathcal{M}_n := \{M \in \mathcal{M} \mid \varepsilon_\alpha > \frac{1}{n}\}$ and noting that if \mathcal{M}_n were countable for every $n \in \mathbb{N}$, then \mathcal{M} would be countable. As it is not, we can find an n so that the collection of manifolds \mathcal{M}_n is uncountable and set $\varepsilon := \frac{1}{n}$ and \mathcal{M}_n to be our new \mathcal{M} . This ε will be used later in the proof.

It will be useful to think about j as counting the embedding and m as describing the size of the ball, and to remember that M is already covered with $j = k$ and $m = 1$.

Each manifold M_α determines an embedding $g_\alpha : B_{k+1}(0) \rightarrow \mathbb{R}^{kl}$ by

$$g_\alpha(x) = (h_{\alpha_1}(x), \dots, h_{\alpha_k}(x)).$$

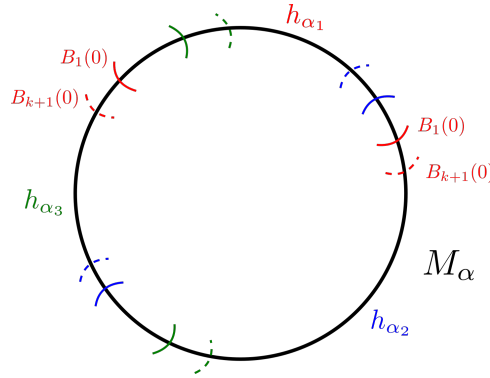

FIGURE 20.2. This is an example of a covering of a 1-manifold $M_\alpha \cong S^1$ with $k = 3$.

We set $\mathcal{G} := \{g_\alpha \mid \alpha \in \mathcal{A}\}$ to be the uncountable set of all such embeddings.

CLAIM. *The set \mathcal{G} is separable and metrizable.*

Proof. We define the uniform metric on \mathcal{G} by

$$d(g_\alpha, g_\beta) := \max_{x \in B_{k+1}(0)} d(g_\alpha(x), g_\beta(x)),$$

which is well-defined since $B_{k+1}(0)$ is compact, and equip \mathcal{G} with the induced topology.

As $\mathcal{G} \subseteq \mathcal{C}(B_{k+1}(0), \mathbb{R}^{kl})$ and we previously showed that subsets of separable metric spaces are separable, we now only need to prove that $\mathcal{C}(B_{k+1}(0), \mathbb{R}^{kl})$ with the uniform metric is separable, as \mathcal{G} then has the subspace topology and is thus also separable. This is a consequence of the theorem of Stone-Weierstrass (a general version and proof can be found in [Rud91, Chapter 5]), which states that every real-valued function from a compact Hausdorff space can be approximated by polynomials. The polynomials can then be approximated by polynomials with rational coefficients, of which there are countably many. To obtain the statement about functions into \mathbb{R}^{kl} instead of real-valued functions, we apply Stone-Weierstrass in each variable separately.

Thus, the set of functions from a compact subset of \mathbb{R}^n into \mathbb{R}^{kl} is separable, and the polynomials with rational coefficients form a countable dense subset. So \mathcal{G} is separable. \square

CLAIM. *There exists some $g_{\alpha_0} \in \mathcal{G}$ that is the limit point of a sequence of embeddings $g_{\alpha_1}, g_{\alpha_2}, \dots$ in \mathcal{G} with $g_{\alpha_i} \neq g_{\alpha_0}$ for all $i \in \mathbb{N} \setminus \{0\}$.*

Proof. We know that \mathcal{G} is an uncountable separable metric space and can thus apply Lemma 20.6. \square

We will now produce a contradiction by constructing a homeomorphism from M_{α_0} to M_{α_i} for i sufficiently large. This homeomorphism will be arbitrarily close to the identity as measured by the metric d . Thus, as we had assumed that all elements in \mathcal{M} are pairwise non-homeomorphic and that $g_{\alpha_i} \neq g_{\alpha_0}$ for all $i \in \mathbb{N}$, we will obtain a contradiction.

To simplify the notation, we will denote M_{α_i} for some fixed but arbitrarily large i by M' . Then define the sets

$$V_j(m) := h_{\alpha_0, j}(B_m(0)) \subseteq M \text{ and } V'_j(m) := h_{\alpha_i, j}(B_m(0)) \subseteq M'$$

with $j = 1, \dots, k$ and $m = 1, \dots, k + 1$, and let

$$U_j(m) := \cup_{p=1}^j V_p(m) \subseteq M \text{ and } U'_j(m) := \cup_{p=1}^j V'_p(m) \subseteq M'.$$

We observe a few properties of these sets:

- $U_k(1) = M$ and $U'_k(1) = M'$ hold.

- Also, $U_j(m) \subseteq U_{j+1}(m)$ and $U_j(m) \subseteq U_j(m+1)$ hold, and so do the analogous statements for $U'_j(m)$.

We define the map $f_j := h_{\alpha_{i,j}} \circ h_{\alpha_{0,j}}^{-1} : V_j(k+1) \rightarrow V'_j(k+1)$.

$$\begin{array}{ccc} V_j(k+1) & \xrightarrow{f_j} & V'_j(k+1) \\ & \searrow h_{\alpha_{0,j}}^{-1} & \nearrow h_{\alpha_{i,j}} \\ & & B_{k+1}(0) \end{array}$$

This map can be arbitrarily close to the identity as measured by the metric d , because the embeddings $h_{\alpha_{i,j}}$ and $h_{\alpha_{0,j}}$ can be arbitrarily close by choosing i big enough, and is a homeomorphism.

To construct the homeomorphism from M to M' , we will proceed inductively. The induction starts with the embedding $g_1 = f_1|_{V_1(k)} : U_1(k) = V_1(k) \hookrightarrow V'_1(k+1) \subseteq M'$. We already know that this embedding can be arbitrarily close to the identity. Given an embedding $g_j : U_j(m) \hookrightarrow M'$ that is close to the identity, we will use theorem [EK71b, Theorem 5.1] to construct an embedding $g_{j+1} : U_{j+1}(m-1) \hookrightarrow M'$ that is also close to the identity. Thus, by setting $k = m$ in the first step, we obtain an embedding $g_k : M = U_k(1) \hookrightarrow M'$ in $k-1$ steps, which we will then show is surjective.

CLAIM. *If g_j is close to the identity relative to the ε defined above and i is big enough,*

$$g_j(U_j(m) \cap V_{j+1}(m)) \subseteq V'_{j+1}(m+1)$$

holds.

Proof. Let the embedding $g_j : U_j(m) \hookrightarrow M'$ be close to the identity relative to ε , which was chosen so that

$$\varepsilon < \varepsilon_\alpha := \min_{j,m} \{d(h_{\alpha_j}(B_m(0)), M_\alpha \setminus h_{\alpha_j}(B_{m+1}(0)))\}$$

for all $\alpha \in \mathcal{A}$. So

$$g_j(U_j(m) \cap V_{j+1}(m)) = g_j((\cup_{p=1}^j V_p(m)) \cap h_{\alpha_{0,j}}(B_m(0))) \subseteq h_{\alpha_{i,j+1}}(B_{m+1}(0)) = V'_{j+1}(m+1)$$

must hold, because g_j was close enough to the identity relative to ε , which measured the distance of $h_{\alpha_j}(B_m(0))$ and $M_\alpha \setminus h_{\alpha_j}(B_{m+1}(0))$ over all $j \in \{1, \dots, k\}$. \square

The composition

$$F = f_{j+1}^{-1} \circ g_j : U_j(m) \cap V_{j+1}(m) \rightarrow V_{j+1}(m)$$

is then well-defined and close to the identity, as both f_{j+1} and g_j were close to the identity.

We apply the following theorem, [EK71b, Theorem 5.1], a proof of which is given in the lecture notes, Theorem 14.8, to extend F to $V_{j+1}(m)$ while it stays fixed on an open set $N \subseteq M$ with

$$U_j(m-1) \cap V_{j+1}(m-1) \subseteq N \subseteq U_j(m) \cap V_{j+1}(m).$$

This is similar to the application of the theorem in the proof of the isotopy extension theorem ([EK71b, Corollary 1.2, Corollary 1.4], Theorem 14.9 in the lecture notes).

THEOREM 20.8. *Let M be a manifold and $C \subseteq U \subseteq M$ where U is an open neighbourhood of the compact set C . Then there exists a neighbourhood P of the inclusion $\eta : U \rightarrow M$ and a deformation*

$$\phi : P \times [0, 1] \rightarrow \text{Emb}(U, M)$$

into $\text{Emb}_C(U, M)$ modulo the complement of a compact neighbourhood of C in U , and fixing η .

The manifold M can have nonempty boundary, the proof in this case is similar to the case with empty boundary sketched in the lecture notes, but uses a boundary collar. Details can be found in [EK71b].

We want to obtain a homeomorphism $\tilde{F}: V_{j+1}(m) \rightarrow V_{j+1}(m)$ that is equal to F on N . So, for the application of the theorem, we set $M = V_{j+1}(m)$, $U = (U_j(m) \cap \overset{\circ}{V}_{j+1}(m))$ and C some compact set with

$$U_j(m-1) \cap V_{j+1}(m-1) \subseteq N := \overset{\circ}{C} \subseteq C \subseteq U \subseteq U_j(m) \cap V_{j+1}(m).$$

This C exists because we can find open disjoint neighbourhoods of $U_j(m-1) \cap V_{j+1}(m-1)$ and of $M \setminus U_j(m) \cap V_{j+1}(m)$ and choose C as the closure of the open neighbourhood of $U_j(m-1) \cap V_{j+1}(m-1)$.

The theorem provides a neighbourhood P of the inclusion and a continuous deformation

$$\phi: P \times [0, 1] \rightarrow \text{Emb}(U, M)$$

into $\text{Emb}_C(U, M)$ modulo the complement of some compact neighbourhood $C \subseteq W \subseteq U$, i.e. $\phi(P \times \{1\}) \subseteq \text{Emb}_C(U, M)$ and $\phi(h, t)|_{U \setminus W} = h|_{U \setminus W}$ for all $h \in P$ and $t \in [0, 1]$.

As $F: U \rightarrow V_{j+1}(m)$ can be obtained to be as close to the inclusion as wished, we can set i to be large enough so that $F \in P$. Applied to F , the theorem gives an isotopy from $\phi(F, 0) = F$ to $G := \phi(F, 1) \in \text{Emb}_C(U, M)$ with $\phi(F, t)|_{U \setminus W} = F|_{U \setminus W}$ for all $t \in [0, 1]$.

We define a map $\tilde{F}: V_{j+1}(m) \rightarrow V_{j+1}(m)$ by

$$\tilde{F} = \begin{cases} FG^{-1}(x) & x \in G(U) \\ x & x \in M \setminus G(W). \end{cases}$$

CLAIM. *The map \tilde{F} is well-defined, continuous, a homeomorphism onto $V_{j+1}(m)$ and coincides with F on C , and thus extends F as we wished.*

Proof.

– \tilde{F} is well-defined:

We know that $G(U) \cap (M \setminus G(W)) = G(U \setminus W)$. For $x \in G(U \setminus W)$, choose $z \in G^{-1}(x)$. As the deformation was modulo $U \setminus W$, the relation $x = G(z) = \phi(F, 1)(z) = F(z)$ holds. We then have

$$FG^{-1}(x) = \phi(F, 0)\phi(F, 1)^{-1}(x) = x.$$

– \tilde{F} is continuous:

The map is continuous as the maps F and G^{-1} are continuous.

– \tilde{F} is a homeomorphism:

Both F and G are embeddings, so FG^{-1} maps $G(U)$ homeomorphically onto $F(U)$.

On $M \setminus G(U)$ we have $\tilde{F}(x) = x$, so \tilde{F} is a homeomorphism.

– $\tilde{F}(x) = F(x)$ on C

On the set C , the maps F and \tilde{F} coincide because $C \subseteq G(U)$ as G can be made close enough to the identity and U is a neighbourhood of C , and thus

$$\tilde{F}(x) = FG^{-1}(x) = F(x)$$

because $G \in \text{Emb}_C(U, M)$.

□

So we have extended F to \tilde{F} .

We now define the map $g_{j+1}: U_{j+1}(m-1) \rightarrow M'$ as

$$g_{j+1}(x) = \begin{cases} g_j(x) & x \in U_j(m-1) \\ f_{j+1}\tilde{F}(x) & x \in V_{j+1}(m-1). \end{cases}$$

CLAIM. The map g_{j+1} is well-defined, continuous and an embedding, more precisely a homeomorphism onto $U'_{j+1}(m-j)$.

Proof.

– g_{j+1} is well-defined:

On $U_j(m-1) \cap V_{j+1}(m-1)$, the relation

$$f_{j+1}\tilde{F}(x) = f_{j+1}FG^{-1}(x) = f_{j+1}F(x) = f_{j+1}f_{j+1}^{-1}g_j(x) = g_j(x)$$

holds, because $U_j(m-1) \cap V_{j+1}(m-1) \subseteq C$, so g_{j+1} is well-defined.

– g_{j+1} is continuous:

The map is continuous as the maps \tilde{F} , f_{j+1} and g_j are continuous.

– g_{j+1} is an embedding and a homeomorphism onto $U'_{j+1}(m+1-j)$:

All the maps F , f_{j+1} and g_j are embeddings and can be arbitrarily close to the identity. By induction, we know that g_j is a homeomorphism onto $U'_j(m+2-j)$. The map g_{j+1} is injective on $U_j(m-1) \setminus N$ (which is a compact set with an open set removed) and $V_{j+1}(m-1) \setminus N$ by definition. The distance between those sets is strictly greater than zero, and on N , the map is injective too. Thus, g_{j+1} is injective if i is big enough, as that means that it is close enough to the identity.

The fact that g_{j+1} is a homeomorphism follows from the fact that \tilde{F} is.

□

Thus, the embedding $g_k(1): U_k(1) = M \rightarrow M' = U'_k(1)$ is a homeomorphism, and it is arbitrarily close to the identity. This means that the manifolds M and M' are homeomorphic, which is a contradiction to the statement that the elements of the sequence were distinct. So our assumption must be false, thus we have proven that there are only countably many manifolds without boundary up to homeomorphism. □

We now give the proof of Theorem 20.3.

Proof of Theorem 20.3. The argument for manifolds with non-empty boundary is similar to the case with empty boundary: we first assume that there are uncountably many compact topological manifolds with boundary and fix some n so that there are uncountably many n -manifolds with boundary. As before, $B_r(x)$ denotes the closed ball of radius r centered at x in \mathbb{R}^n . We then choose an $(n-1)$ -manifold B without boundary such that the set of all n -manifolds whose boundary is homeomorphic to this manifold is uncountable, and restrict to this case. As we have proven above that there are only countably many closed $(n-1)$ -manifolds, such a manifold B must exist, and this restriction is no loss of generality. So we get an uncountable set $\mathcal{M} = \{M_\alpha\}_{\alpha \in \mathcal{A}}$ of n -manifolds, each with boundary B .

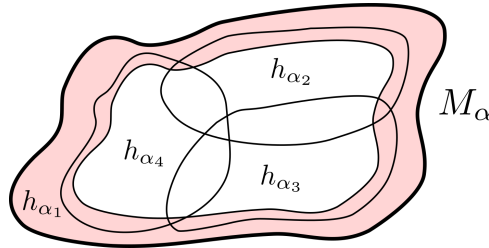

FIGURE 20.3. This is an example of a covering of a 2-manifold with boundary $M_\alpha \cong D^2$ with $k = 4$.

We choose finite covers for the manifolds in \mathcal{M} analogously to the case with empty boundary and an integer k such that there are uncountably many compact manifolds covered by k embedded closed balls in the same way. By the collaring theorem (first shown in [Bro62b],

Theorem 6.5 in the lecture notes), each manifold in this set has a collared boundary, so for M_α there exists an embedding $h_{\alpha_1}: B \times [0, k + 1] \rightarrow M_\alpha$ with $h_{\alpha_1}(b, 0) = b$ for all $b \in B$. The finite cover of M_α gives us embeddings $h_{\alpha_j}: B_{k+1}(0) \rightarrow M_\alpha$ such that M_α is covered by $\{h_{\alpha_1}(B \times [0, 1]), h_{\alpha_2}(B(1)), \dots, h_{\alpha_k}(B(1))\}$. We embed M_α in $\mathbb{R}^{2n+1} = \mathbb{R}^l$ as in the first part of the proof of Theorem 20.7 and define an embedding $g_\alpha: B \times [0, k + 1] \times B_{k+1}(0) \rightarrow \mathbb{R}^{kl}$ by

$$g_\alpha(x, t, y) = (h_{\alpha_1}(x, t), h_{\alpha_2}(y), \dots, h_{\alpha_k}(y))$$

for every manifold M_α in \mathcal{M} . We denote the set of all such embeddings for $\alpha \in \mathcal{A}$ by \mathcal{G} .

By the same arguments as before, there is an embedding $g_{\alpha_0} \in \mathcal{G}$ that is the limit point of a sequence $g_{\alpha_1}, g_{\alpha_2}, \dots$ in \mathcal{G} with $g_{\alpha_0} \neq g_{\alpha_i}$ for all $i \in \mathbb{N}$. As in the proof for manifolds with empty boundary, we set $M' = M_{\alpha_i}$ for some i that is fixed, but arbitrarily large. We define $V_1(m) := h_{\alpha_0,1}(B \times [0, m])$ and $V'_1(m) := h_{\alpha_i,1}(B \times [0, m])$ with $m = 1, \dots, k + 1$. The sets $V_j(m)$ and $V'_j(m)$ for $j = 2, \dots, k$ as well as $U_j(m)$ and $U'_j(m)$ are defined as before, and the rest of the proof constructs a homeomorphism from M to M' in the same way as the proof for manifolds with empty boundary, as all statements used can also be applied to manifolds with boundary. \square

20.5. Application to Morse theory

In their paper [CK70], Cheeger and Kister also present a topological submersion theorem that is an application of their results and useful in topological Morse theory. We will now state these results and sketch a proof.

Definition 20.9. A map $f: X \rightarrow Y$ is called *proper* if the preimages of compact sets are compact, i.e. for all compact $C \subseteq Y$, the set $f^{-1}(C)$ is compact. We call a continuous map $f: X \rightarrow Y$ *monotone* if the inverse image of any point in $f(X)$ is a connected subset of X .

Let Y be an m -manifold and X be an n -manifold, and thus metrisable. Let d be a metric on X . Let $f: X \rightarrow Y$ be a proper monotone map satisfying the following condition:

(\star)

for every $x \in X$ there are closed neighbourhoods $f(x) \in U \subseteq Y$ and $x \in V \subseteq X$ and a homeomorphism $h: B_2(0) \times U \rightarrow V$ such that $f \circ h$ is the projection map onto U .

We define $M_y := f^{-1}(y)$ for $y \in Y$.

PROPOSITION 20.10. *For every $y \in Y$, M_y is a compact connected topological $(m - n)$ -manifold.*

Proof. We know that M_y is compact and connected because the map f is proper and monotone. It is also Hausdorff as a subset of a Hausdorff space.

To show it is locally $(m - n)$ -euclidean, take any $x \in M_y \subseteq X$. By the condition mentioned above, there is some neighbourhood V of x that is homeomorphic to $B_2(0) \times U$. As Y is an n -manifold, there is some neighbourhood of $f(x)$ in U that is isomorphic to \mathbb{R}^n . We can now restrict h to $B_2(0)$ cross this neighbourhood and obtain that M_y is locally $(m - n)$ -euclidean and thus a compact topological $(m - n)$ -manifold.

As M_y is compact and locally $(m - n)$ -euclidean, it can be covered by finitely many open balls. We know that \mathbb{R}^{m-n} is second-countable, so we can find a countable basis of the topology of M_y by considering the images of the bases of the balls that we embedded. \square

We fix $y_0 \in Y$ and can find a collection of embeddings

$$\{h_{y_j}: B_2(0) \rightarrow M_y \mid y \in U, j = 1, 2, \dots, k\}$$

where U is a closed neighbourhood of y_0 in Y , and $\{h_{y_j}(B_1(0))\}_{j=1}^k$ covers M_y . For fixed j , the embeddings h_{y_j} vary continuously in y as embeddings of $B_2(0)$ into X . We apply the method

from the proof of Theorem 20.7 to construct a homeomorphism $g: M_{y_0} \rightarrow M_y$ for y in a small enough neighbourhood U' of y_0 . This is canonical and continuous in y because the result from [EK71b] was too.

Then the map $g: M_{y_0} \times U' \rightarrow X$ that we define as $g(x, y) = g_y(x)$ is a local trivialization of f .

This result can be applied to topological Morse theory. For this purpose, we first want to define some very basic concepts from topological Morse theory, as they can be found in [SS99].

Definition 20.11. Let X be a connected topological n -manifold and $f: X \rightarrow \mathbb{R}_+$ a continuous function. Then $x \in X$ is an *ordinary point* of f if there exists an open neighbourhood V of x in X and a homeomorphic parametrization of V by n parameters such that one of them is f . Otherwise, x is a *critical point* of f .

A critical point x of f is called *non-degenerate* if there exists an open neighbourhood V of x in X , a homeomorphic parametrization of V by parameters y_1, \dots, y_n and an integer $0 \leq j \leq n$ such that, for all $u \in U$,

$$f(u) - f(x) = \sum_{i=1}^j y_i^2 - \sum_{i=j+1}^n y_i^2$$

holds.

Such a function f is called a *topological Morse function* if all critical points of f are non-degenerate.

Applying the previous consideration to this case results in the following statement:

PROPOSITION 20.12. *Let X be a compact connected topological $(n+1)$ -manifold, $Y = [0, 1]$ and $f: X \rightarrow Y$ be a topological Morse function without critical points, i.e. all point $x \in X$ are ordinary points. Then f is a trivial bundle map with fiber a compact manifold.*

Proof. The map f , which is a topological Morse function without critical points, is proper and monotone. To prove that f is proper, let $C \subseteq [0, 1]$ be a compact set, and thus in particular closed, as $[0, 1]$ is a Hausdorff space. Then $f^{-1}(C) \subseteq X$ is also compact because it is a closed subset of a compact manifold.

Let $t \in [0, 1]$ be any point. The preimage of t under f cannot be empty. We can see this as the image is nonempty, connected, closed, because X is compact, and open, because we can find an open neighbourhood around any point using the condition that any point of X is an ordinary point of f . Thus, the image must be all of Y . Similarly to the proof of Proposition 20.10, we can see that $f^{-1}(t)$ is a compact manifold. If we assume that the preimage of t is not connected, we can find two points $x, y \in X$ with $f(x) = f(y) = t$ that are in different path components of $f^{-1}(t)$, but that can be connected by a path $\gamma \subseteq X$ in X , as X is a connected, and thus path-connected manifold. Then there must be a point in $f(\gamma)$ that is not an ordinary point of f , which is a contradiction to our first assumption that f has no critical points.

The map f meets the condition \star by definition by setting V to be the closure of the open neighbourhood in the definition of a Morse function and $U = f(V)$. The homeomorphic parametrization yields exactly the necessary homeomorphism such that $f \circ h$ is the projection.

We can then analogously define M_t as $f^{-1}(t)$ and construct a homeomorphism $g: M_{t_0} \rightarrow M_t$ for t in a small enough neighbourhood of t_0 , and the map $g: M_{t_0} \times U' \rightarrow X$, defined as $g(x, y) = g_y(x)$ is a local trivialization of f . As these homeomorphisms change continuously and all points of f are ordinary points, the map f is a trivial bundle map with fiber a compact n -manifold. \square

Part VII

Smoothing and PL-ing theory

Classifying spaces

Mark Powell

We will now study classifying spaces $B\text{TOP}(n)$, $B\text{PL}(n)$ and $BO(n)$ for the corresponding three types of \mathbb{R}^n fibre bundles, and their stable analogues $B\text{TOP}$, $B\text{PL}$ and BO .

The relationship between these objects is that we will define the limiting classifying spaces, for $\text{CAT} = \text{TOP}, \text{PL},$ or O , as

$$BCAT := \bigcup_n BCAT(n)$$

using the inclusions $BCAT(n) \hookrightarrow BCAT(n+1)$ induced by crossing with the identity map on \mathbb{R} .

The stable classifying spaces in particular will play a key rôle in smoothing and PL-ing theory, which we are going to discuss in the next section. This theory enables us to decide whether one can put the extra corresponding extra structure, smooth or PL respectively, on a topological manifold, and can decide how many such structures exist.

The theory of classifying spaces gives rise to universal spaces whose homotopy types measure the difference between the categories. These spaces, quite amazingly, allow us to convert geometric computations for specific manifolds into global statements for all manifolds.

The key property of classifying spaces that we will use is that homotopy classes of maps to them correspond to isomorphism classes of the related bundles. For example, $[X, BO(n)]$ is in bijection with the isomorphism classes of n -dimensional vector bundles over the CW complex X , and $[X, BO]$ is in bijection with the collection of stable isomorphism classes of vector bundles over X .

To connect with the previous section, there is a forgetful map $f: BO \rightarrow B\text{TOP}$ and for a topological manifold M there is a classifying map $t_M: M \rightarrow B\text{TOP}$ of the stable tangent microbundle. The tangent microbundle is, stably, the underlying microbundle of a smooth vector bundle if and only if there is a lift $\tau_M: M \rightarrow BO$ with $t_M = f \circ \tau_M: M \rightarrow BO \rightarrow B\text{TOP}$. The analogous statement holds for PL instead of O . So in particular classifying spaces can decide whether there exists a smooth or PL structure on $M \times \mathbb{R}^q$ for some q . We will also see that they can quantify these structures.

The classifying spaces $BO(n)$ may be already familiar to you; they are given by the Grassmannian of n -planes in \mathbb{R}^∞ . See e.g. [MS74]. The others take a bit more work to describe. To do so we briefly recall the notion of a semi-simplicial set.

21.1. Semi-simplicial sets

Definition 21.1. Define the category Δ_\bullet to have objects

$$\{ \{0, 1, \dots, n\} \mid n \in \mathbb{N}_0 \}$$

and morphisms the injective order-preserving maps

$$\{0, 1, \dots, m\} \rightarrow \{0, 1, \dots, n\}$$

for $m \leq n$.

We write $[n] := \{0, 1, \dots, n\}$. There are n injective order preserving maps

$$[n-1] := \{0, 1, \dots, n-1\} \rightarrow [n] := \{0, 1, \dots, n\}.$$

Definition 21.2. A *semi-simplicial set/group/space* is a functor

$$S_{\bullet} : \Delta_{\bullet}^{\text{op}} \rightarrow \begin{cases} \text{Set} \\ \text{Group} \\ \text{Space} \end{cases}$$

from the opposite category of Δ_{\bullet} to the appropriate category of sets, groups, or spaces.

For a comprehensive source on semi-simplicial sets and spaces, we refer to [ER19]. This definition is quick to make, but not so easy to parse, so we unwind it a little. A semi-simplicial set consists of the following.

- (i) For each $p \in \mathbb{N}_0$, a set, the *set of p -simplices*, $X_p := X_{\bullet}([p])$.
- (ii) A collection of maps $\partial_i^p : X_p \rightarrow X_{p-1}$, for $i = 0, \dots, p$, such that

$$\partial_i^{p-1} \circ \partial_j^p = \partial_{j-1}^{p-1} \circ \partial_i^p : X_p \rightarrow X_{p-2} \quad i < j.$$

These are called the *face maps*.

Example 21.3. As an example, a simplicial complex determines a semi-simplicial set, where the p simplices are the p -simplices, and the face maps give rise to the ∂_i^p .

Here is another famous example. For any space Y , the *singular semi-simplicial set* Y_{\bullet} of Y is the semi-simplicial set with p -simplices Y_p given by the singular p -simplices, that is the continuous maps of the geometric simplex Δ_p to Y . Precomposing with the inclusion of the i th face $\Delta^{p-1} \rightarrow \Delta^p$ gives the map $\partial_i^p : Y_p \rightarrow Y_{p-1}$.

Remark 21.4. You may have heard of the notion of simplicial sets. These have extra structure, the so-called *degeneracy maps*. In some contexts, having this extra structure is very important. Our aim is to pass to geometric realisations, and the geometric realisation of a simplicial set and its underlying semi-simplicial set are homotopy equivalent, so there is no need to

Here is our main example.

Example 21.5. Let Γ be a monoid, e.g. $\Gamma = \text{TOP}(n)$. We define the semi-simplicial set $B\Gamma_{\bullet}$ as the following collection of data. $B\Gamma_0$ is a singleton, and for each $p > 0$ we have the set of p -simplices:

$$B\Gamma_p := \{(g_1, \dots, g_p) \mid g_i \in \Gamma\}$$

and for every $0 \leq i \leq p$ a boundary map

$$\partial_i^p : B\Gamma_p \rightarrow B\Gamma_{p-1} \quad (g_1, \dots, g_p) \mapsto \begin{cases} (g_2, \dots, g_p), & i = 0 \\ (g_1, \dots, g_i \cdot g_{i+1}, g_{i+2}, \dots, g_p), & 1 \leq i \leq p-1 \\ (g_1, \dots, g_{p-1}), & i = p. \end{cases}$$

Then we have that $\partial_i^{p-1} \circ \partial_j^p = \partial_{j-1}^{p-1} \circ \partial_i^p$ for $i < j$, fulfilling the definition of a semi-simplicial set.

This is easy to generalise to any small category, with the 0-simplices the objects, and with p -tuples of composable morphisms as the p -simplices.

In another direction, if Γ is a topological monoid or group then $B\Gamma_p$ is a *space*, and $B\Gamma_{\bullet}$ is a semi-simplicial *space*.

Note that this definition of a semi-simplicial space also encapsulates any monoid Γ , since we can give a monoid Γ the discrete topology, in order to make it into a topological monoid, albeit in a somewhat uninteresting way. When we apply this machinery with $\Gamma = O(n)$ or $\text{TOP}(n)$, the topology on these spaces is not the discrete topology, it will be the usual topology on $O(n)$ as a subset of \mathbb{R}^{n^2} , and the compact-open topology on $\text{TOP}(n)$.

Definition 21.6 (Geometric realisation). Let X_\bullet be a semi-simplicial set/space. The *geometric realisation* $\|X_\bullet\|$ of X_\bullet is defined as the quotient

$$\|X_\bullet\| := \bigsqcup_{p \geq 0} X_p \times \Delta^p / \sim.$$

Here we consider X_p as a space using the discrete topology, in the case that X_\bullet is a semi-simplicial set, and we use the given topology on X_p in the case that X_\bullet is a semi-simplicial space. Δ_p is a space, with the subspace topology from \mathbb{R}^{p+1} :

$$\Delta^p := \{(x_0, \dots, x_p) \in \mathbb{R}^{p+1} \mid \sum_{j=0}^p x_j = 1, x_j \geq 0 \text{ for all } j\}.$$

Let $\iota_i^{p-1}: \Delta^{p-1} \hookrightarrow \Delta^p$ be the inclusion of i th face, for $i = 0, \dots, p$. The equivalence relation is given by:

$$(x, \iota_i^{p-1}(y)) \sim (\partial_i^p x, y)$$

for $x \in X_p, y \in \Delta^{p-1}$ and $0 \leq i \leq p$.

Definition 21.7. Given a (topological) monoid Γ , for the semi-simplicial set (space) from Example 21.5, define $B\Gamma := \|B\Gamma_\bullet\|$, the geometric realisation of this semi-simplicial set (space).

This concludes our short introduction to semi-simplicial sets. We have just included enough information in order to be able to describe the constructions of the classifying spaces we will need. The properties of classifying spaces will be assumed without proof, since this theory is not special to the world of topological manifolds. To understand these properties in more detail, we would need to expand on the theory of semi-simplicial sets and spaces as well.

21.2. Defining classifying spaces

Definition 21.8. Apply Example 21.5 and Definition 21.7 to the topological groups (and therefore monoids) $\text{TOP}(n)$ and $O(n)$ to obtain semi-simplicial spaces $B\text{TOP}(n)_\bullet$ and $BO(n)_\bullet$. Similarly this construction applied to the topological monoid $G(n)$ of homotopy self-equivalences of S^{n-1} yields the semi-simplicial space $BG(n)_\bullet$. Then we have:

$$\begin{aligned} B\text{TOP}(n) &:= \|B\text{TOP}(n)_\bullet\| \\ BO(n)' &:= \|BO(n)_\bullet\|. \end{aligned}$$

THEOREM 21.9. *We have a homotopy equivalence $BO(n)' \simeq BO(n) := \text{Gr}_n(\mathbb{R}^\infty)$.*

It can be useful to have both models for the same homotopy type. The former can be more easily compared with $B\text{TOP}(n)$, while the latter can be useful for computations, and the fact that it is a limit of smooth manifolds was used when we found a smooth structure on $M \times \mathbb{R}^q$ in Section 9.3.

For the piecewise linear case we need a slightly more involved construction.

Example 21.10. We define a semi-simplicial set $\text{PL}(n)_\bullet$. Define $\text{PL}(n)_p$ to be the set of PL homeomorphisms $\Delta^p \times \mathbb{R}^n \rightarrow \Delta^p \times \mathbb{R}^n$ such that

$$\begin{array}{ccc} \Delta^p \times \mathbb{R}^n & \xrightarrow{\quad\quad\quad} & \Delta^p \times \mathbb{R}^n \\ & \searrow & \swarrow \\ & \Delta^p & \end{array}$$

commutes, where the downwards arrows are projection onto the first factor. Define a map $\text{PL}(n)_p \rightarrow \text{PL}(n)_{p-1}$ by sending $f: \Delta^p \times \mathbb{R}^n \rightarrow \Delta^p \times \mathbb{R}^n$ to the restriction

$$f|_{\iota_i^{p-1}(\Delta^{p-1}) \times \mathbb{R}^n}: \Delta^{p-1} \times \mathbb{R}^n \rightarrow \Delta^{p-1} \times \mathbb{R}^n.$$

This determines a semi-simplicial set $\text{PL}(n)_\bullet$. Note that we do not have a natural topology on the sets here. We will use the geometric realisation to obtain a topology. That is, we define:

$$\text{PL}(n) := \|\text{PL}(n)_\bullet\|.$$

Example 21.11. Now we define $B\text{PL}(n)$. For each $p \geq 0$, note that $\text{PL}(n)_p$, the PL-homeomorphisms of $\Delta^p \times \mathbb{R}^n$ over Δ^p , is a group (not a topological group). Form the semi-simplicial set $B(\text{PL}(n)_p)_\bullet$ via the procedure in Example 21.5.

Then we define a semi-simplicial space Y_\bullet by

$$Y_p := \|B(\text{PL}(n)_p)_\bullet\|$$

Now each Y_p is a space. The face maps $\partial_i^q(Y) : Y_q \rightarrow Y_{q-1}$ of Y_\bullet are induced by the face maps of $\text{PL}(n)_\bullet$:

$$\text{Id} \times (\partial_i^p)^q : \Delta^q \times (\text{PL}(n)_p)^q \rightarrow \Delta^q \times (\text{PL}(n)_{p-1})^q.$$

Finally we define

$$B\text{PL}(n) := \|Y_\bullet\|$$

as the geometric realisation of the semi-simplicial space Y_\bullet . We performed a level-wise B construction, and then we combined the levels into a semi-simplicial space Y_\bullet , and then realising that gave the classifying space $B\text{PL}(n)$.

Ultimately, for our intended applications to smoothing and PLing of topological manifolds, we will need the stable classifying spaces. For each of $\text{CAT} = \text{TOP}, \text{PL}, O$, define

$$\text{CAT}(n) \hookrightarrow \text{CAT}(n+1)$$

inclusions induced by crossing with the identity map on \mathbb{R} . These in turn induce maps $B\text{CAT}(n) \hookrightarrow B\text{CAT}(n+1)$. If necessary replace these by cofibrations using mapping cylinders, and define

$$B\text{CAT} := \bigcup_n B\text{CAT}(n)$$

to be the infinite union. This defines stable classifying spaces

$$BO, B\text{PL}, \text{ and } B\text{TOP}.$$

The key fact about all of these classifying space is the following theorem.

THEOREM 21.12. *If X be a paracompact space. For $n \in \mathbb{N}$ there is a universal CAT bundle $\gamma_{\text{CAT}}^n \rightarrow B\text{CAT}(n)$ such that the correspondence*

$$[f : X \rightarrow B\text{CAT}(n)] \mapsto f^*(\gamma_{\text{CAT}}^n)$$

induces a 1-1 correspondence between homotopy classes of maps $[X, B\text{CAT}(n)]$ and isomorphism classes of CAT \mathbb{R}^n -bundles.

Similarly stable isomorphism classes of such bundles are in 1-1 correspondence with homotopy classes of maps $[X, B\text{CAT}]$.

Taking the classifying map of the underlying $\text{TOP}(n)$ bundle of the universal CAT \mathbb{R}^n bundle γ_{CAT}^n induces a homotopy class of maps

$$p_{\text{CAT}}(n) : B\text{CAT}(n) \rightarrow B\text{TOP}(n)$$

. This respects the stabilisations, so that

$$\begin{array}{ccccccc} \dots & \longrightarrow & B\text{CAT}(n) & \longrightarrow & B\text{CAT}(n+1) & \longrightarrow & \dots \\ & & \downarrow p_{\text{CAT}}(n) & & \downarrow p_{\text{CAT}}(n+1) & & \\ \dots & \longrightarrow & B\text{TOP}(n) & \longrightarrow & B\text{TOP}(n+1) & \longrightarrow & \dots \end{array}$$

commutes. In the limit we obtain a map

$$p_{\text{CAT}}: \text{BCAT} \rightarrow B \text{TOP}.$$

Studying the failure of this map to be a homotopy equivalence measures the difference between topological and CAT manifolds. We will start this process in the next section.

21.3. Comparing stable classifying spaces.

Let CAT stand for PL or DIFF. Since many facts and proofs will work equally well for both PL and DIFF categories, it will be convenient to have the notation CAT that refers to either of them.

We define the spaces

$$\begin{aligned} \text{TOP}/_{\text{CAT}} &:= \text{hofib}\left(\text{BCAT} \xrightarrow{p_{\text{CAT}}} B \text{TOP}\right) \\ &:= \{(x, \gamma) \mid x \in \text{BCAT}, \gamma: [0, 1] \rightarrow B \text{TOP}, \gamma(0) = x, \gamma(1) = p_{\text{CAT}}(x)\} \end{aligned}$$

as the homotopy fibre of the map $p_{\text{CAT}}: \text{BCAT} \rightarrow B \text{TOP}$. This is the same as replacing this map by a fibration, changing BCAT by a homotopy equivalence to a path space, and then taking the fibre at the basepoint. So there is a homotopy fibre sequence

$$\text{TOP}/_{\text{CAT}} \xrightarrow{j} \text{BCAT} \xrightarrow{p_{\text{CAT}}} B \text{TOP}.$$

Similarly there are fibre sequences

$$\begin{aligned} \text{TOP}^{(n)}/_{\text{CAT}^{(n)}} &\longrightarrow \text{BCAT}^{(n)} \longrightarrow B \text{TOP}^{(n)} \\ \text{PL}/_{\text{O}} &\longrightarrow \text{BO} \longrightarrow B \text{PL} \\ \text{PL}^{(n)}/_{\text{O}^{(n)}} &\longrightarrow \text{BO}^{(n)} \longrightarrow B \text{PL}^{(n)}. \end{aligned}$$

In each case the left-most space is by definition the homotopy fibre of the right hand map. We will restrict attention to the stable versions from now on, since it is these that are relevant for smoothing and PL-ing theory in the next section.

THEOREM 21.13 (Boardman-Vogt [BV68]). *The space $\text{TOP}/_{\text{CAT}}$ has the homotopy type of a loop space, that is there exists a space $B^{\text{TOP}}/_{\text{CAT}}$ such that*

$$\text{TOP}/_{\text{CAT}} \simeq \Omega B^{\text{TOP}}/_{\text{CAT}}.$$

In fact, the stable classifying spaces and their homotopy fibres $\text{TOP}/_{\text{CAT}}$, BCAT , $B \text{TOP}$, $B \text{PL}$, BO , and $\text{PL}/_{\text{O}}$ are infinite loop spaces.

An elementary consequence is that

$$\pi_i\left(\text{TOP}/_{\text{CAT}}\right) \cong \pi_i\left(\Omega B^{\text{TOP}}/_{\text{CAT}}\right) \cong \pi_{i+1}\left(B^{\text{TOP}}/_{\text{CAT}}\right).$$

Now we relate CAT bundle structures to lifts of classifying maps. A CAT structure Σ on a manifold M determines a CAT tangent bundle, and therefore a lift of the stable classifying map $\mathfrak{t}_M: M \rightarrow B \text{TOP}$ to BCAT .

Let M be a topological manifold with ∂M equipped with a CAT structure. Then we have the diagram:

$$(21.1) \quad \begin{array}{ccccccc} & & \partial M & \xleftarrow{\text{incl}} & M & & \\ & & \rho \downarrow & & \theta \nearrow & & \downarrow \mathfrak{t}_M \\ \text{TOP}/\text{CAT} & \xrightarrow{j} & \text{BCAT} & \xrightarrow{F} & B \text{TOP} & \xrightarrow{G} & B \text{TOP}/\text{CAT}. \end{array}$$

The bottom row is a fibration sequence, and the first three entries form a principal fibration. Therefore, questions about existence and uniqueness of CAT structures on \mathfrak{t}_M , extending the given CAT structure on the topological tangent bundle of ∂M , are equivalent to the existence and uniqueness respectively of a lift of the map θ . This leads to the following theorem. To state it we need the notion of concordant bundle structures.

Definition 21.14. Let ξ be a TOP \mathbb{R}^n bundle over a CAT manifold X . Consider stable CAT-bundles ξ_0 and ξ_1 over X with $|\xi_0| \cong_s \xi \cong_s |\xi_1|$, i.e. ξ_0 and ξ_1 are stable CAT bundles lifting ξ . A (stable) *concordance* between ξ_0 and ξ_1 is a CAT bundle γ over $X \times I$ extending ξ_i on $X \times \{i\}$, for $i = 0, 1$, and with a stable isomorphism $|\gamma| \cong_s \xi \times \mathfrak{t}_I$ to the product of ξ with the topological tangent bundle of the interval I .

A concordance between CAT lifts of a topological \mathbb{R}^n fibre bundle over X is a CAT lift of the product bundle on $X \times I$.

THEOREM 21.15. *Let M be a topological manifold with dimension at least 5 and ∂M given a fixed CAT structure.*

- (i) *The stable tangent microbundle \mathfrak{t}_M is stably isomorphic to $|\xi|$ for some CAT bundle ξ if and only if there exists a lift $\theta: M \rightarrow \text{BCAT}$ with $\mathfrak{t}_M \simeq F \circ \theta$, if and only if the map $G \circ \mathfrak{t}_M: M \rightarrow B \text{TOP}/\text{CAT}$ is null homotopic.*
- (ii) *Moreover, the set $[(M, \partial M), (\text{TOP}/\text{CAT}, *)]$ acts freely and transitively on the concordance classes of stable CAT bundles $\theta: M \rightarrow \text{BCAT}$ lifting \mathfrak{t}_M and extending ρ . So after fixing one such lift θ , assuming one exists, there is a one to one correspondence between concordance classes of stable CAT bundles lifting \mathfrak{t}_M and $[(M, \partial M), (\text{TOP}/\text{CAT}, *)]$.*

So we have two tasks. On the one hand, we need to understand the homotopy type of the spaces TOP/CAT, so we can understand when a bundle’s classifying map lifts from $B \text{TOP}$ to BCAT . On the other hand, given such a suitable lift, we need to make use of it to actually produce a CAT structure, or an equivalence of CAT structures. This is the topic of smoothing/PLing theory, which we discuss next.

Introduction to the product structure theorem, and smoothing and PL-ing theory

Danica Kosanović and Mark Powell

As before, we let CAT stand for PL or DIFF.

Definition 22.1. A CAT structure Γ on a topological manifold M is a maximal CAT atlas, that is the transition functions are CAT; we shall write M_Γ to indicate M with the CAT structure Γ .

We use the term CAT isomorphism for a PL homeomorphism or a diffeomorphism, as appropriate.

Definition 22.2. Two CAT structures Γ, Γ' on M are CAT-isomorphic if there is a homeomorphism $h: M \rightarrow M$ with $h^{-1}(\Gamma') = \Gamma$.

If h is homotopic to Id_M rel. ∂M , then (M, h) and (M, Id) represent the same element of the structure set $\mathcal{S}_{\text{CAT}}(M, \partial M)$.

Definition 22.3. An *isotopy* between CAT structures Σ and Σ' on a manifold M is a path of (TOP) homeomorphisms $h_t: M \rightarrow M$ from $h_0 = \text{Id}_M$ to a CAT isomorphism $h_1: M_\Sigma \rightarrow M_{\Sigma'}$.

Each h_t can be used to pullback Σ' , so an isotopy gives a continuous family of CAT structures on M , starting with Σ' and ending with Σ .

Definition 22.4. A *concordance* of CAT structures on M is a CAT structure Γ on $M \times I$, where $I = [0, 1]$. We say that Γ is a concordance from Σ_0 to Σ_1 , with $\Sigma_i := \Gamma|_{M \times \{i\}}$.

Note that isotopic CAT structures are concordant and CAT-isomorphic. We will discuss the other possible implications below.

For both of CAT equals PL or DIFF, we shall discuss the following two important theorems, and their consequences.

- (1) Concordance implies Isotopy.
- (2) The Product Structure Theorem.

We will start with statements of these results and their applications to the questions of whether a topological manifold admits a smooth or PL structure. We will give the proofs later on. We are going to start with the simplest statements, and gradually introduce more complications in relative versions as we go on.

The results will again rely on PL or smooth results associated with the s -cobordism theorem and surgery theory. In particular the proof of the product structure theorem relies on the stable homeomorphism theorem. As such dimension restrictions will again appear, and in fact the results will in general be false if one tries to extend them to include 4-manifolds. We will state the precise dimension restrictions at each stage. Dimension at least six is always safe. For some results about 5-manifolds, such as in the well-definedness of connected sum (Theorem 17.29), results about codimension one 4-manifolds will appear, meaning that we have to be careful.

We should note that many of the problems with dimension 4 were fixed by Quinn, but at the moment we are presenting the state of topological manifolds in 1978, that is after Kirby-Siebenmann's book appeared but before Quinn's work.

THEOREM 22.5 (Concordance implies Isotopy for CAT structures). *Assume $\partial M = \emptyset$ and $\dim M \geq 5$ and let Γ be a CAT structure on $M \times I$, that is, a concordance from Σ_0 to Σ_1 .*

Then there exists an isotopy $h_t: M \times I \rightarrow M \times I$ with

- (1) $h_0 = \text{Id}_{M \times I}$,
- (2) $h_1: (M \times I)_{\Sigma \times I} \rightarrow (M \times I)_{\Gamma}$ is a CAT isomorphism,
- (3) $h_t|_{M \times \{0\}} = \text{Id}_{M \times \{0\}}$ for all $t \in [0, 1]$.

We say that $h_t|_{M \times \{1\}}$ is an isotopy of CAT structures from Σ_1 to Σ_0 .

Example 22.6. The cardinality of the set of smooth structures on S^7 up to diffeomorphism is 15. Up to concordance, or up to orientation preserving diffeomorphism, there are 28 of them, and indeed the smooth structures on S^n considered up to concordance forms an abelian group θ_n , the group of homotopy spheres, with addition by connected sum and the standard smooth S^7 as the identity element. This group was computed in many cases by Kervaire and Milnor [KM63a].

Remark 22.7. Note that for CAT structures isotopy implies both concordance and diffeomorphism. The above result shows that concordance implies isotopy for closed manifolds of dimension ≥ 5 . However, diffeomorphism does not imply concordance (nor isotopy) as the above example shows.

THEOREM 22.8 (Product Structure Theorem). *Assume $\partial M = \emptyset$ and $\dim M \geq 5$, and let Θ be a CAT structure on $M \times \mathbb{R}^q$ for some $q \geq 1$. Then there is a concordance $(M \times \mathbb{R}^q \times I)_{\Gamma}$ from Θ to $(M \times \mathbb{R}^q)_{\Sigma \times \mathbb{R}^q}$, where the latter CAT structure is the product of a structure Σ on M and the standard structure on \mathbb{R}^q .*

In particular, M admits a CAT structure, which is moreover unique up to concordance.

COROLLARY 22.9. *Assume $\partial M = \emptyset$ and $\dim M \geq 5$. Suppose that the stable tangent microbundle satisfies $\mathfrak{t}_M \cong |\xi|$, where $|\xi|$ is the underlying microbundle of a CAT bundle $\xi \rightarrow M$. Then M admits a CAT structure.*

Proof. By the ‘precursor to smoothing’ Theorem 9.19 we know that there exists a CAT structure on $M \times \mathbb{R}^q$ for some $q \geq 1$. By Theorem 22.8 we obtain a CAT structure on M . \square

Here if CAT = DIFF bundle then a CAT bundle is a vector bundle. A CAT = PL bundle is an \mathbb{R}^n fibre bundle, where $n = \dim M$, with structure group $\text{PL}(n)$, the PL homeomorphisms of \mathbb{R}^n that fix the origin. There is a theory of PL-microbundles, and there is an analogue to Kister’s theorem, due to Kuiper-Lashof [KL66], which says that every PL microbundle contains a PL fibre bundle. We are unfortunately omitting to develop the theory of PL bundles, with the assurance that it is analogous to the smooth theory of vector bundles in so far as we will need it.

Remark 22.10. Strictly speaking, we only considered smooth structures in Section 9.3, but the same proofs work in PL category. Namely, we obtained the smooth structure on $M \times \mathbb{R}^q$ by realising $M \times \mathbb{R}^q$ as an open subset in a large dimensional Euclidean space, and we then pulled back the smooth structure from the Euclidean space. We can do the same with the PL structure. For now we will take it on faith, and refer to [KS77b, Essay IV, Theorem 3.1 and Proposition 5.1].

Recall that Theorem 9.19 relied on Theorem 9.14 on the stable existence of normal microbundles for topological submanifolds. There are different proofs for this by Milnor, Hirsch, and Stern.

Now we upgrade our statement of the product structure theorem to a relative form, that will be useful for questions about the uniqueness of structures.

THEOREM 22.11 (Relative Product Structure Theorem). *Let M be a manifold and fix an open subset $U \subseteq M$. Assume $\dim M \geq 6$, or $\dim M = 5$ with $\partial M \subseteq U$. Let Θ be a CAT structure on $M \times \mathbb{R}^q$ for some $q \geq 1$, and suppose there exists a CAT structure ρ on U with $\Theta|_{U \times \mathbb{R}^q} = \rho \times \mathbb{R}^q$.*

Then ρ extends to a CAT structure Σ , and there is a concordance $(M \times \mathbb{R}^q \times I)_\Gamma$ from Θ to $(M \times \mathbb{R}^q)_{\Sigma \times \mathbb{R}^q}$ relative to $U \times \mathbb{R}^q$.

COROLLARY 22.12. *Let Σ_0, Σ_1 be CAT structures on M with $\dim M \geq 4$ and $\partial M = \emptyset$. The CAT structures induce CAT tangent bundles with microbundle isomorphisms $|TM_{\Sigma_i}| \rightarrow \mathfrak{t}_M$ for $i = 0, 1$. Suppose that there exists a concordance between the CAT bundle structures TM_{Σ_0} and TM_{Σ_1} . That is, there is a CAT bundle $\xi \rightarrow M \times I$ restricting to TM_{Σ_i} on $M \times \{i\}$, and a stable microbundle isomorphism $|\xi| \xrightarrow{\cong_s} \mathfrak{t}_{M \times I}$.*

Then Σ_0 and Σ_1 are concordant. Moreover if $\dim M \geq 5$ then they are isotopic.

Proof. Let U be the union of open collars on $M \times \{i\}$ for $i = 0, 1$, and put product structures $\Sigma_i \times [0, \varepsilon)$ on each of these collars. By a relative version of Milnor's Theorem 9.19, there exists $q \geq 1$ and a CAT structure on $M \times I \times \mathbb{R}^q$ restricting to $\Sigma_i \times \mathbb{R}^q$ on $U \times \mathbb{R}^q$. Then by Theorem 22.11 we obtain a CAT structure on $M \times I$. That is, Σ_0 and Σ_1 are concordant.

If $\dim M \geq 5$ then we have that they are also isotopic by Theorem 22.5. \square

Remark 22.13. The requirement that $\partial M = \emptyset$ is not necessary, but was added to make the notation in the statement and the proof easier. More care is needed to state a relative version, in which one assumes that in a closed set $C \subseteq M$ containing the boundary we already have a fixed concordance.

Remark 22.14. We also did not prove a relative version of Theorem 9.19. The proof proceeds analogously, but with more care required.

Remark 22.15. Note that this implies that each of the uncountably many exotic structures on \mathbb{R}^4 are concordant to one another, while they are not diffeomorphic to each other and therefore are not isotopic. So concordance implies isotopy is false for 4-manifolds.

To compare to [KS77b], we have shown that the *smoothing rule* σ , which in [KS77b, Essay IV, Proposition 3.4] is defined by exactly the procedure we have used to obtain CAT structures, is a well-defined map from stable concordance classes of stable CAT bundle structures on \mathfrak{t}_M to concordance classes of CAT structures on M .

That is, the smoothing rule is to apply the method of Theorem 9.19 to obtain a CAT structure on $M \times \mathbb{R}^q$, for some q , from a CAT bundle whose underlying microbundle is the tangent microbundle of M , and then apply the product structure theorem to obtain a CAT structure on M . We have shown that concordant stable CAT structures on \mathfrak{t}_M give rise to concordant CAT structures on $M \times \mathbb{R}^q$, and the product structure theorem gives uniqueness of the resulting smooth structure on M up to concordance.

In fact, [KS77b, Essay IV, Theorem 4.1] shows that σ is a bijection from stable concordance classes of stable CAT bundle structures on \mathfrak{t}_M to concordance classes of CAT structures on M . We also now include the possibility that the boundary is nonempty, but we assume that the structures are already equal on the boundary.

THEOREM 22.16 ([KS77b, Essay IV, Theorem 4.1]). *Let M be a topological manifold with $\dim M \geq 5$ and ∂M given a fixed CAT structure. Then the smoothing rule gives rise to a bijection between stable concordance classes of stable CAT bundle structures on \mathfrak{t}_M and the set of concordance classes of CAT structures on M .*

Next we will refine the smoothing rule using classifying spaces. By combining Theorem 22.16 with Theorem 21.15, we obtain the following theorem. We use the fact from Theorem 21.15 that the CAT bundle structures on the topological tangent bundle of M are controlled by lifts of the classifying map, and therefore are controlled by maps to $B^{\text{TOP}}/\text{CAT}$ and TOP/CAT .

THEOREM 22.17. *Let M be a topological manifold with dimension at least 5 and ∂M given a fixed CAT structure.*

The map $G \circ \mathfrak{t}_M: M \rightarrow B^{\text{TOP}}/\text{CAT}$ is null homotopic if and only if M admits a CAT structure extending the structure on ∂M .

Moreover, the set $[(M, \partial M), (\text{TOP}/\text{CAT}, *)]$ acts freely and transitively on the concordance classes of CAT structures fixing the structure on ∂M . So after fixing one such CAT structure, assuming one exists, there is a one to one correspondence between concordance classes of CAT structures extending the structure on ∂M and $[(M, \partial M), (\text{TOP}/\text{CAT}, *)]$.

COROLLARY 22.18 ([Sta62a]). For $n \geq 5$, \mathbb{R}^n has a unique CAT structure.

Proof. Assuming Theorem 22.17, since \mathbb{R}^n is contractible we have that $[\mathbb{R}^n, \text{TOP}/\text{CAT}] = \{*\}$. Therefore there is a unique CAT structure on \mathbb{R}^n , $n \geq 5$, as claimed. \square

This corollary was first proved by Stallings in [Sta62a]. Actually we will need this statement for $n \geq 6$ in the proof of the product structure theorem. So we had better give an independent argument, and indeed we shall do so later (our argument will be different from Stallings' argument). Nevertheless for a user of the theory, it is often easier to remember the one central theorem, and deduce everything else from it, which is why we have also pointed it out as a corollary.

For Theorem 22.17 to be useful for non-contractible spaces we need to understand something about the homotopy type of the spaces TOP/CAT and $B^{\text{TOP}}/\text{CAT}$. This is the topic of the next section, but for the piecewise-linear case, the homotopy type is easy to describe.

THEOREM 22.19 (Kirby-Siebenmann). We have a homotopy equivalence $\text{TOP}/\text{PL} \simeq K(\mathbb{Z}/2, 3)$.

We will prove this soon. Let us observe some consequences now, however. It follows that the obstruction for existence of a lift θ as in (21.1) lies in the group

$$[(M, \partial M), (B^{\text{TOP}}/\text{PL}, *)] \cong H^4(M, \partial M; \mathbb{Z}/2),$$

This obstruction is called the *Kirby-Siebenmann* invariant of $(M, \partial M)$. If this obstruction vanishes, all such lifts are classified by the group

$$[(M, \partial M), (\text{TOP}/\text{PL}, *)] \cong H^3(M, \partial M; \mathbb{Z}/2).$$

In particular Theorem 22.17 and Theorem 22.19 imply the following remarkable theorem.

THEOREM 22.20. Let M be a topological manifold with dimension at least 5 and ∂M given a fixed PL structure.

- (1) Suppose $H^4(M, \partial M; \mathbb{Z}/2) = 0$. Then the PL structure on ∂M extends to M .
- (2) Suppose that $H^3(M, \partial M; \mathbb{Z}/2) = 0$. Then any two PL structures Σ_0 and Σ_1 on M satisfying $\Sigma_0|_{\partial M} = \Sigma_1|_{\partial M}$ are isotopic.

Remark 22.21. Note the corollary that a compact topological manifold with dimension at least 5 has finitely many PL structures rel. boundary, up to isotopy (it may of course have zero such structures).

The homotopy groups of TOP / PL and TOP / O

Danica Kosanović and Mark Powell

We have seen that it would be extremely useful to know about the homotopy groups of TOP / PL and TOP / O. This section explains how to compute them. To start, the homotopy groups $\pi_k(\text{TOP}/\text{PL})$ and $\pi_k(\text{TOP}/\text{O})$ for $k \geq 5$ are easy to compute.

LEMMA 23.1. *For $k \geq 5$ we have*

$$\pi_k(\text{TOP}/\text{PL}) = 0, \quad \text{and} \quad \pi_k(\text{TOP}/\text{O}) \cong \Theta_k$$

where Θ_k is the group of homotopy spheres, that is h -cobordism classes of smooth, closed, oriented k -manifolds homotopy equivalent to S^k .

Proof. For $k \geq 5$, the set $[S^k, \text{TOP}/\text{CAT}]$ is in one-to-one correspondence with concordance classes of CAT structures on S^k , which, via the CAT h -cobordism theorem, equals $\{*\}$ for CAT = PL and equals Θ_k for CAT = DIFF. \square

Recall, for example, that famously $\Theta_7 \cong \mathbb{Z}/28$. Unlike the PL Poincaré conjecture, the smooth Poincaré conjecture is not true in many dimensions. It is true in dimensions 5, 6, 12, 56, and 61. It is open in infinitely many dimensions. The groups of homotopy spheres are related to the homotopy groups of spheres, more precisely to the cokernel of the J -homomorphism. So difficulties computing the latter translate into difficulties computing the former. It is known that Θ_k is finite for all $k \geq 5$.

23.1. Smoothing of piecewise-linear manifolds and the homotopy groups of PL/O

There is an analogous theory for the smoothing of piecewise-linear manifolds. There is a fibration sequence

$$\text{PL}/\text{O} \rightarrow \text{BO} \rightarrow \text{BPL}$$

with PL/O by definition the homotopy fibre. Also PL/O is an infinite loop space, so admits a delooping $B\text{PL}/\text{O}$.

THEOREM 23.2 (Cairns-Hirsch, Hirsch-Mazur). *Given a closed PL manifold M , the map*

$$M \xrightarrow{t_M} \text{BPL} \longrightarrow B\text{PL}/\text{O}$$

is null homotopic if and only if M is smoothable. Moreover concordance classes of smooth structures on M are in 1-1 correspondence with $[M, \text{PL}/\text{O}]$

We can describe the homotopy groups $\pi_k(\text{PL}/\text{O})$. By the Poincaré conjecture, and its smooth failure (Smale, Stallings, Zeeman, Kervaire-Milnor),

$$\pi_k(\text{PL}/\text{O}) \cong \Theta_k$$

for $k \geq 5$. Note that Kervaire-Milnor computed that $\Theta_5 = \Theta_6 = 0$ and $\Theta_7 \cong \mathbb{Z}/28$.

In addition, $\pi_k(PL/O) = 0$ for $k \leq 4$. This follows from direct geometric proofs that PL manifolds of dimension $k \leq 4$ admit smooth structures, due to Munkres, Smale, and Cerf. We therefore have the following fact.

THEOREM 23.3. *The space PL/O is 6-connected.*

To summarise, in general a PL manifold may admit no smooth structures, or multiple smooth structures. Since Θ_k is finite, a given compact PL manifold admits finitely many smooth structures, up to concordance. These are detected via maps to PL/O . In dimensions at most 5, every PL manifold admits a unique smooth structure. This is not to be confused with the fact that a given topological 4-manifold may admit infinitely many PL (and therefore smooth) structures.

23.2. Homotopy groups of TOP/O

We will focus on the question of putting a PL structure on a topological manifold, since this has a particularly clean answer. This can be seen, e.g. from Lemma 23.1. In contrast, for $CAT = DIFF$, we have to account for nontrivial smooth homotopy spheres. We now show that there are no additional sources of trouble.

THEOREM 23.4.

$$\pi_k(TOP/O) \cong \pi_k(TOP/PL)$$

for $0 \leq i \leq 4$, while

$$\pi_k(TOP/O) \cong \pi_k(PL/O)$$

for $i \geq 5$.

Proof. Apply Theorem 22.19, Theorem 23.3, and the long exact sequence in homotopy groups associated to the fibre sequence

$$PL/O \longrightarrow TOP/O \longrightarrow TOP/PL,$$

to see that we have

$$\pi_k(TOP/O) \cong \begin{cases} \pi_k(TOP/PL) \cong \pi_k(K(\mathbb{Z}/2, 3)) & 0 \leq k \leq 4 \\ \pi_k(PL/O) \cong \Theta_k & k \geq 5. \end{cases}$$

□

COROLLARY 23.5. *Every compact topological manifold of dimension at least 6 admits finitely many smooth/ PL structures (including possibly zero).*

Proof. This follows from obstruction theory and the theorem of Kervaire-Milnor that $|\Theta_k| < \infty$, together with Theorem 22.19 that $\pi_k(TOP/PL)$ is finite for $k \leq 4$. □

The corollary holds for compact 5-manifolds as well, provided we fix a CAT structure on the 4-dimensional boundary.

23.3. The homotopy groups of TOP/PL

In this section we give the proof of Theorem 22.19. Here is the statement again.

THEOREM 23.6. $TOP/PL \simeq K(\mathbb{Z}/2, 3)$.

This means, remarkably, that the difference between the topological and piecewise-linear categories, is rather small. From the point of view of obstruction theory, there is just a single $\mathbb{Z}/2$ obstruction. The proof we are going to present is from [KS77b, Essay IV chapter 10 and Essay V Theorem 5.3].

By Lemma 23.1 it remains to compute $\pi_k(\text{TOP/PL})$ for $0 \leq k \leq 4$. First of all we will show that $\pi_k(\text{TOP/PL}) = 0$ for $i = 0, 1, 2$, and 4, and that $\pi_3(\text{TOP/PL}) \leq \mathbb{Z}/2$. To do this we shall define, for each $0 \leq k \leq 4$, a map

$$\psi_k: \pi_k(\text{TOP/PL}) \rightarrow \mathcal{S}_{\text{PL}}^*(D^k \times T^{6-k}, \partial)$$

We will define $\mathcal{S}_{\text{PL}}^*(D^k \times T^{6-k}, \partial)$ in detail below.

Our overall aims for this computation are as follows. We will show that ψ_k is injective and that the right hand side is zero for $k = 0, 1, 2, 4$ and is $\mathbb{Z}/2$ for $k = 3$. Once we have shown all of this we will show separately that $\pi_3(\text{TOP/PL})$ is nontrivial.

The set $\mathcal{S}_{\text{PL}}^*(D^k \times T^{6-k}, \partial)$ is by definition the subset of the structure set

$$\mathcal{S}_{\text{PL}}(D^k \times T^{6-k}, \partial) := \left\{ \begin{array}{ccc} M & \xrightarrow{\cong} & D^k \times T^{6-k} \\ \uparrow & & \uparrow \\ \partial M & \xrightarrow{\cong_{\text{PL}}} & S^{k-1} \times T^{6-k} \end{array} \right\} / \text{PL homeo over } D^k \times T^{6-k}$$

consisting of those elements which are invariant under passing to λ^{6-k} covers for all $\lambda \in \mathbb{N}$. That is, passing to a λ^{6-k} cover

$$\begin{array}{ccc} \widetilde{M} & \xrightarrow{\cong} & D^k \times \widetilde{T^{6-k}} \\ \uparrow & & \uparrow \\ \widetilde{\partial M} & \xrightarrow{\cong_{\text{PL}}} & S^{k-1} \times \widetilde{T^{6-k}} \end{array}$$

yields an equivalent element in $\mathcal{S}_{\text{PL}}(D^k \times T^{6-k}, \partial)$. We are considering the rel. boundary structure set. The equivalence relation stipulates that

$$\begin{array}{ccc} M & \xrightarrow[\cong_F]{} & D^k \times T^{6-k} \\ \uparrow & & \uparrow \\ \partial M & \xrightarrow[\cong_{\text{PL}}]{\cong_{\partial F}} & S^{k-1} \times T^{6-k} \end{array} \quad \text{and} \quad \begin{array}{ccc} M' & \xrightarrow[\cong_{F'}]{} & D^k \times T^{6-k} \\ \uparrow & & \uparrow \\ \partial M' & \xrightarrow[\cong_{\partial F'}]{\cong_{\text{PL}}} & S^{k-1} \times T^{6-k} \end{array}$$

are equivalent if there are PL homeomorphisms

$$\begin{array}{ccc} M & \xrightarrow[\cong_G]{\cong_{\text{PL}}} & M' \\ \uparrow & & \uparrow \\ \partial M & \xrightarrow[\cong_{\partial G}]{\cong_{\text{PL}}} & \partial M' \end{array}$$

such that $\partial F' \circ \partial G = \partial F$ and $F' \circ G \sim F$. So the commutativity of the triangles

$$\begin{array}{ccc} M & \xrightarrow{G} & M' \\ & \searrow F & \swarrow F' \\ & D^k \times T^{6-k} & \end{array} \quad \text{and} \quad \begin{array}{ccc} \partial M & \xrightarrow{\partial G} & \partial M' \\ & \searrow \partial F & \swarrow \partial F' \\ & S^{k-1} \times T^{6-k} & \end{array}$$

is up to homotopy for the first triangle and precise commutativity for the second triangle.

23.3.1. Definition of ψ_k . To define

$$\psi_k: \pi_k \left(\text{TOP}/\text{PL} \right) \rightarrow \mathcal{S}_{\text{PL}}^*(D^k \times T^{6-k}, \partial),$$

fix a basepoint $*$ \in TOP/PL and represent $x \in \pi_k(\text{TOP}/\text{PL}, *)$ by a diagram:

$$\begin{array}{ccc} D^k & \longrightarrow & \text{TOP}/\text{PL} \\ \uparrow & & \uparrow \\ S^{k-1} & \longrightarrow & * \end{array}$$

Combining these maps with the projection maps pr_1 onto the first factor, we obtain a diagram

$$\begin{array}{ccccc} D^k \times T^{6-k} & \xrightarrow{\text{pr}_1} & D^k & \longrightarrow & \text{TOP}/\text{PL} \\ \uparrow & & \uparrow & & \uparrow \\ S^{k-1} \times T^{6-k} & \xrightarrow{\text{pr}_1} & S^{k-1} & \longrightarrow & * \end{array}$$

Write \bar{x} for the resulting map of pairs

$$\bar{x}: (D^k \times T^{6-k}, S^{k-1} \times T^{6-k}) \rightarrow (\text{TOP}/\text{PL}, *).$$

We know from Theorem 22.17 that the set of homotopy classes of such maps acts freely and transitively on the concordance classes of PL structures on $(D^k \times T^{6-k}, S^{k-1} \times T^{6-k})$.

Let $(M, \partial M)$ denote $(D^k \times T^{6-k}, S^{k-1} \times T^{6-k})$ with the PL structure obtained by acting on the standard structure by \bar{x} . It does not change the PL structure on the boundary. This maps by the identity to $D^k \times T^{6-k}$. Thus we obtain

$$(F, \partial F): (M, \partial M) \xrightarrow{\cong, \cong_{\text{PL}}} (D^k \times T^{6-k}, S^{k-1} \times T^{6-k})$$

since the identity map on the underlying topological manifolds is in particular a homotopy equivalence.

The induced structure on a λ^{6-k} cover is that induced by

$$D^k \times T^{6-k} \xrightarrow{\text{Id} \times \lambda^{6-k}} D^k \times T^{6-k} \xrightarrow{\text{pr}_1} D^k \xrightarrow{\bar{x}} \text{TOP}/\text{PL}$$

Since this map equals the original map $\bar{x}: D^k \times T^{6-k} \rightarrow \text{TOP}/\text{PL}$, we see that element of the structure set $(F, \partial F): (M, \partial M) \rightarrow (D^k \times T^{6-k}, S^{k-1} \times T^{6-k})$ is invariant under passing to finite covers and therefore determines an element of $\mathcal{S}_{\text{PL}}^*(D^k \times T^{6-k}, \partial)$.

23.3.2. Injectivity of ψ_k . Having defined the map ψ_k , we now show that it is injective.

It will be useful to recall the definition of an isotopy of PL-structures from Definition 22.3.

Definition 23.7. An *isotopy* between PL structures Σ and Σ' on a manifold M is a path of homeomorphisms $h_t: M \rightarrow M$ from $h_0 = \text{Id}_M$ to a PL homeomorphism $h_1: M_\Sigma \rightarrow M_{\Sigma'}$.

Each h_t can be used to pullback Σ' , so an isotopy gives a continuous family of PL structures on M , starting with Σ' and ending with Σ .

LEMMA 23.8. For $k = 0, 1, 2, 3, 4$, the map $\psi_k: \pi_k \left(\text{TOP}/\text{PL} \right) \rightarrow \mathcal{S}_{\text{PL}}^*(D^k \times T^{6-k}, \partial)$ is injective.

Remark 23.9. In Kirby-Siebenmann, it is only shown that the inverse image of the trivial element is the trivial element. It is implicitly assumed that the structure set is a group, and that ψ_k is a homomorphism, but this is not discussed, although it seems to be true. We will avoid this question by showing that the map is injective as a map of sets.

Proof. Suppose that $\psi_k(x) = \psi_k(y)$ in the structure set. That is, $\psi_k(x)$ and $\psi_k(y)$ give rise to PL structure Σ and Σ' on $D^k \times T^{6-k}$, and there exists a PL homeomorphism

$$h: [D^k \times T^{6-k}]_{\Sigma'} \xrightarrow{\cong_{PL}} [D^k \times T^{6-k}]_{\Sigma}$$

which the identity near the boundary, and moreover $h \sim \text{Id}$ rel. boundary. We want to show that $x = y \in \pi_k(\text{TOP} / \text{PL})$.

Lifting to a λ^{6-k} cover, for some $\lambda \in \mathbb{N}$, gives structures $[D^k \times T^{6-k}]_{\Sigma_\lambda}$ and $[D^k \times T^{6-k}]_{\Sigma'_\lambda}$ defined to make $\text{Id} \times \lambda^{6-k}$ a PL map. We obtain a diagram of PL maps:

$$\begin{array}{ccc} (D^k \times T^{6-k})_{\Sigma'_\lambda} & \xrightarrow{\cong} & (D^k \times T^{6-k})_{\Sigma_\lambda} \\ \text{Id} \times \lambda^{6-k} \downarrow & & \downarrow \text{Id} \times \lambda^{6-k} \\ (D^k \times T^{6-k})_{\Sigma'} & \xrightarrow{\cong} & (D^k \times T^{6-k})_{\Sigma} \end{array}$$

Observe that for λ sufficiently large, we can make h_λ arbitrarily close to the identity on T^{6-k} . In addition, extend h_λ by the identity to

$$\bar{h}_\lambda: \mathbb{R}^k \times T^{6-k} \rightarrow \mathbb{R}^k \times T^{6-k}.$$

Let $H_t: \mathbb{R}^k \rightarrow \mathbb{R}^k$ be an isotopy shrinking D^k to be very small, with H_0 the identity, and H_1 the result of this shrink. Define

$$G_t := (H_t \times \text{Id}) \circ \bar{h}_\lambda \circ (H_t \times \text{Id})^{-1}: [D^k \times T^{6-k}]_{\Sigma'_\lambda} \rightarrow [D^k \times T^{6-k}]_{\Sigma_\lambda}.$$

This is an isotopy on $D^k \times T^{6-k}$ with G_0 the identity and with G_1 arbitrarily close to the identity.

Now by the local path connectedness of $\text{Homeo}_\partial(D^k \times T^{6-k})$ (Theorem 19.1), G_1 is isotopic to the identity, which implies that h_λ is isotopic to the identity. Therefore we have an isotopy of homeomorphisms from a PL homeomorphism

$$h_\lambda: [D^k \times T^{6-k}]_{\Sigma'_\lambda} \rightarrow [D^k \times T^{6-k}]_{\Sigma_\lambda}$$

to the identity map. Therefore Σ_λ and Σ'_λ are isotopic PL structures, which means that the maps $D^k \times T^{6-k} \rightarrow \text{TOP} / \text{PL}$ which produced them are homotopic. Now consider the diagram:

$$\begin{array}{ccccc} & & D^k \times T^{6-k} & & \\ & \nearrow & \downarrow \lambda^{6-k} & \searrow \Sigma_\lambda, \Sigma'_\lambda & \\ D^k \times \{\text{pt}\} & \longrightarrow & D^k \times T^{6-k} & \xrightarrow{\bar{x}, \bar{y}} & \text{TOP} / \text{PL} \\ & \searrow \text{Id} & \downarrow \text{pr}_1 & \nearrow x, y & \\ & & D^k & & \end{array}$$

Here the maps with codomain TOP / PL indicate two maps. We label the maps that determine the structures Σ_λ and Σ'_λ by the structure. The diagram commutes by definition of the maps involved. We have seen that there is a homotopy between the maps Σ_λ and Σ'_λ . This induces a homotopy between the two maps $D^k \times \{\text{pt}\} \rightarrow \text{TOP} / \text{PL}$ via the top route. By commutativity of the diagram this induces a homotopy between the two maps via the bottom route. Hence x is homotopic to y as desired. \square

23.3.3. Computation of $\mathcal{S}_{PL}^*(D^3 \times T^n, \partial)$. So far we did not apply any surgery theory computations. Now we need to appeal to them. Recall we discussed the surgery classification of PL homotopy tori in Chapter 18. The results discussed there generalise to the following. Before, we focused on the case $k = 0$ that we needed for the proof of the stable homeomorphism theorem.

THEOREM 23.10 ([HS69, Wal69]). *There is an isomorphism*

$$\mathcal{S}_{PL}(D^k \times T^n, S^{k-1} \times T^n) \cong H^{3-k}(T^n, \mathbb{Z}/2)$$

with $n + k \geq 5$ and this bijection is natural under finite covers. In particular, if $k = 0$, we have $H^3(T^n; \mathbb{Z}/2) = (\wedge^{n-3} \mathbb{Z}^n) \otimes \mathbb{Z}/2$ from before.

COROLLARY 23.11. *The subset of the structure set $\mathcal{S}_{PL}(D^k \times T^n, S^{k-1} \times T^n)$ that is invariant under finite covers is trivial unless $k = 3$. For $k = 3$ we have*

$$\mathcal{S}_{PL}^*(D^3 \times T^n, \partial) \cong H^0(T^n; \mathbb{Z}/2) \cong \mathbb{Z}/2.$$

So we have that

$$\psi_k: \pi_k(\text{TOP/PL}) \hookrightarrow \mathcal{S}_{PL}^*(D^k \times T^{6-k}, \partial)$$

has trivial right hand side for $k = 0, 1, 2, 4$. We see that $\pi_k(\text{TOP/PL}) \cong \pi_k(\text{TOP/O}) = 1$ for $k = 0, 1, 2, 4$ and we have an injective map $\psi_3: \pi_3(\text{TOP/PL}) \rightarrow \mathbb{Z}/2$. It therefore just remains to show that $\pi_3(\text{TOP/PL})$ is nontrivial.

To do this, first we construct an element of $\mathcal{S}_{PL}^*(D^3 \times T^n, \partial)$ and show it is nontrivial.

For $k + n \geq 6$, a fake $D^k \times T^n$, i.e. a manifold homotopy equivalent to $D^k \times T^n$, with PL-homeomorphic boundary but not PL homeomorphic to $D^k \times T^n$, arises from elements of

$$L_{n+k+1}(\mathbb{Z}[\mathbb{Z}^n]) / \mathcal{N}(D^k \times T^n \times I, D^k \times T^n \times \{0, 1\}).$$

To create a fake $D^k \times T^n$, for $k + n \geq 6$, choose $y \in L_{n+k+1}(\mathbb{Z}[\mathbb{Z}^n])$ such that y does not lie in the image of $\mathcal{N}(D^k \times T^n \times I, D^k \times T^n \times \{0, 1\})$, and realise y , using Wall realisation, by a normal bordism starting with the identity of $D^k \times T^n$, and ending with a new homotopy equivalence $F: M \rightarrow D^k \times T^n$. See Fig. 23.1a. The new pair (M, F) is a degree one normal map with F a homotopy equivalence, but F is not homotopic rel. boundary to a PL homeomorphism.

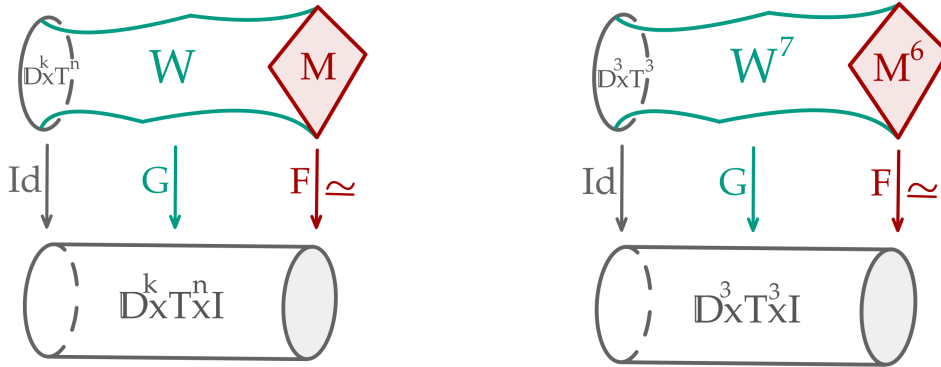

(A) A normal bordism produces a pair (M, F) . (B) A normal bordism for $M \simeq D^3 \times T^3$.

FIGURE 23.1

We now consider an invariant that can be used to detect if M is PL homeomorphic to $D^k \times T^n$. Let us focus on the case of interest: $k = n = 3$. Given a PL manifold M and $F: M^6 \xrightarrow{\simeq} D^3 \times T^3$, we choose a PL normal bordism

$$(G, F, \text{Id}): (W^7; M^6, D^3 \times T^3) \rightarrow D^3 \times T^3 \times (I; \{0\}, \{1\}).$$

We then cross this bordism with $\mathbb{C}\mathbb{P}^2$, so that we can apply results from the high dimensional theory, avoiding 4-manifolds. We obtain a map

$$G \times \text{Id}: W \times \mathbb{C}\mathbb{P}^2 \rightarrow D^3 \times T^3 \times I \times \mathbb{C}\mathbb{P}^2$$

between 11-manifolds. By PL transversality, the inverse image

$$W' := (G \times \text{Id})^{-1}(D^3 \times \{\text{pt}\} \times I \times \mathbb{C}\mathbb{P}^2)$$

is a PL 8-manifold with boundary, over $D^4 \times \mathbb{C}\mathbb{P}^2$, such that the map of its boundary to $S^3 \times \mathbb{C}\mathbb{P}^2$ is a PL homeomorphism. Take its (simply-connected) surgery obstruction in $L_8(\mathbb{Z})$. We know that $L_8(\mathbb{Z}) \cong \mathbb{Z}$ where the map takes the signature divided by 8, and we take the modulo 2:

$$L_8(\mathbb{Z}) \xrightarrow{\cong} \mathbb{Z} \longrightarrow \mathbb{Z}/2$$

We claim that this is a well-defined obstruction to the original map G being normally bordant to a homotopy equivalence. This follows from Farrell's fibering theorem, which implies that if G were bordant to a homotopy equivalence, then the surgery obstruction of

$$W' \rightarrow D^4 \times \mathbb{C}\mathbb{P}^2$$

would be trivial. Finally, note that $\sigma(X) = \sigma(X \times \mathbb{C}\mathbb{P}^2)$ for a 4-manifold X , since signature multiplies under products and $\sigma(\mathbb{C}\mathbb{P}^2) = 1$.

THEOREM 23.12 (Rochlin). *If X a PL spin closed 4-manifold, then $\sigma(X)$ is divisible by 16.*

The obstruction $\sigma(W')/8 \pmod 2$ cannot be killed by a change in normal bordism, because that would change the inverse image by a closed, spin 4-manifold crossed with $\mathbb{C}\mathbb{P}^2$, and by the Rochlin theorem this changes the signature obstruction in $L_8(\mathbb{Z})$ by a multiple of 16.

23.3.4. Nontriviality of $\pi_3(\text{TOP}/\text{PL})$. We showed $\pi_k(\text{TOP}/\text{PL}) = 0$ for $k \neq 3$, and that

$$\pi_3(\text{TOP}/\text{PL}) \subseteq \mathcal{S}_3^*(D^3 \times T^3, \partial) \cong \mathbb{Z}/2.$$

Now we show that this inclusion is equality, i.e. that $\pi_3(\text{TOP}/\text{PL})$ is nontrivial.

Remark 23.13. If we knew that all the fake tori in dimensions at least 5 are homeomorphic to one another, instead of just homotopy equivalent, then we would be done. However while this is true, it is harder to establish, and the proof might even use this result by comparing with the PL case. The method we are about to explain has the advantage that it uses machinery that we have already proven, or are assuming from the DIFF/PL development.

Definition 23.14. Let $\text{PL}(D^3 \times T^3, \partial)$ be the set of PL structures on $D^3 \times T^3$, restricting to standard structure on $S^2 \times T^3$, considered up to isotopy.

LEMMA 23.15. *There is an isomorphism $\phi: \pi_3(\text{TOP}/\text{PL}) \xrightarrow{\cong} \text{PL}(D^3 \times T^3, \partial)$.*

Proof. By the Product Structure Theorem (Theorem 22.8) we have

$$\begin{aligned} \text{PL}(D^3 \times T^3, \partial) &\cong [(D^3 \times T^3, \partial), (\text{TOP}/\text{PL}, *)] \\ &\cong H^3(D^3 \times T^3; \pi_3(\text{TOP}/\text{PL})). \end{aligned}$$

We do not yet know whether $\pi_3(\text{TOP}/\text{PL})$ is trivial or $\mathbb{Z}/2$, but we do not mind. Now by Poincare-Lefschetz duality this is

$$H^3(D^3 \times T^3; \pi_3(\text{TOP}/\text{PL})) \cong H_3(T^3; \pi_3(\text{TOP}/\text{PL})) \cong 2\pi_3(\text{TOP}/\text{PL}).$$

We denote the inverse of this chain of isomorphisms by ϕ . □

We have maps

$$\pi_3(\text{TOP}/\text{PL}) \xrightarrow[\cong]{\phi} \text{PL}(D^3 \times T^3, \partial) \xrightarrow{\theta} \mathcal{S}_3^*(D^3 \times T^3, \partial)$$

where by definition $\theta((D^3 \times T^3)_\Sigma) = \text{Id}: (D^3 \times T^3)_\Sigma \xrightarrow{\cong} D^3 \times T^3$. We have to show that θ is onto. This means that we take the nontrivial element of the codomain, which might be represented by

some other manifold M that is homotopy equivalent to $D^3 \times T^3$, rel. boundary and we try to show that the M is in fact in the image of $\text{PL}(D^3 \times T^3, \partial)$, so it is homeomorphic to $D^3 \times T^3$, but is perhaps not PL-homeomorphic.

PROPOSITION 23.16. *The map $\theta: \text{PL}(D^3 \times T^3, \partial) \rightarrow \mathcal{S}_3^*(D^3 \times T^3, \partial)$ is onto.*

Proof. Consider the nontrivial element of the structure set $\mathcal{S}_3^*(D^3 \times T^3, \partial)$

$$f: (M, \partial M) \xrightarrow{\cong, \cong_{\text{PL}}} (D^3 \times T^3, \partial)$$

We will construct a topological homeomorphism $h: M \rightarrow D^3 \times T^3$ and show that f is homotopic to h rel. boundary. This will show that f is in the image of θ .

For the rest of proof let us identify $D^3 \cong I^3 = [0, 1]^3$. Consider the triple

$$(M; f^{-1}(\{0\} \times I^2 \times T^3), f^{-1}(\{1\} \times I^2 \times T^3).$$

By the rel. boundary s -cobordism theorem, there is a PL homeomorphism $f': M \xrightarrow{\cong_{\text{PL}}} I^3 \times T^3$ with $f' = f$ on $f^{-1}(\{1\} \times I^2 \cup I \times \partial I^2) \times T^3$. Next we investigate the failure of f' to equal f on the remaining part of the boundary, $\{0\} \times I^2 \times T^3$. Namely, consider the PL homeomorphism

$$g := f' \circ f|^{-1}: \{0\} \times I^2 \times T^3 \rightarrow \{0\} \times I^2 \times T^3$$

LEMMA 23.17. *g is TOP isotopic to the identity $\text{Id}_{I^2 \times T^3}$.*

Assuming for a moment such an isotopy exists, we can glue it in a collar neighbourhood of $\{0\} \times I^2 \times T^3$ to alter f' , see Fig. 23.2. This produces the desired homeomorphism $h: M \rightarrow I^3 \times T^3$ which is equal to f near ∂M , and it remains to check that h is homotopic to f .

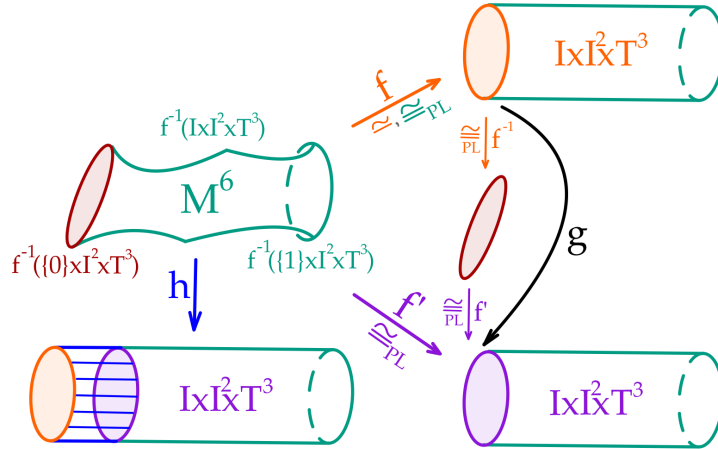

FIGURE 23.2. Modifying the PL homeomorphism f' by attaching into the collar of $\{0\} \times I^2 \times T^3$ an isotopy of g to the identity.

LEMMA 23.18. *If two homeomorphisms h and f from M to $I^3 \times T^3$ agree near ∂M , then they are homotopic rel. boundary.*

Proof. The obstructions to extending

$$h \cup h \times \text{Id}_I \cup f: M \times \{0\} \cup \partial M \times I \cup M \times \{1\} \rightarrow I \times I^3 \times T^3$$

to the homotopy $M \times I \rightarrow I^3 \times T^3$ lie in $H^{j+1}(I^4 \times T^3, \partial; \pi_j(I^3, \times T^3)) \cong H_{7-j-1}(T^3; \pi_j(T^3))$. This is always zero, since $\pi_j(T^3) \neq 0$ implies that $j = 0, 1$, so that $7 - j - 1$ is 5 or 6. But the cohomology of T^3 is trivial above degree 3. □

This finishes the proof of the proposition, modulo the proof of Lemma 23.17. □

Proof of Lemma 23.17. We use a similar method to that used in the injectivity of ψ_k proof: we note that M can be replaced by a large finite λ^3 -fold cover M_λ , and similarly f by f_λ . We have that

$$[(M, f)] = [(M_\lambda, f_\lambda)] \in \mathcal{S}_{\text{PL}}^*(I^3 \times D^3, \partial)$$

by invariance under finite covers. By the procedure above, we obtain analogous maps

$$f'_\lambda: M_\lambda \rightarrow I \times I^2 \times T_\lambda^3 \quad \text{and} \quad g_\lambda: I^2 \times T_\lambda^3 \rightarrow I^2 \times T_\lambda^3.$$

LEMMA 23.19. *There is a finite λ^3 cover such that the map g_λ is TOP isotopic to $\text{Id}_{I^2 \times T_\lambda^3}$.*

Proof. Passing to a large λ^3 finite cover, and squeezing in the I^2 coordinate, we may obtain a map that is as close to the identity as we please, which is therefore isotopic to the identity by local contractibility. More details follow.

Observe that for λ sufficiently large, g_λ is arbitrarily close to the identity on T_λ^3 . In addition, extend g_λ by the identity to

$$\bar{g}_\lambda: \mathbb{R}^2 \times T_\lambda^3 \rightarrow \mathbb{R}^2 \times T_\lambda^3.$$

Let $H_t: \mathbb{R}^2 \rightarrow \mathbb{R}^2$ be an isotopy shrinking D^2 to be very small, with H_0 the identity, and H_1 the result of this shrink. Define

$$G_t := (H_t \times \text{Id}) \circ \bar{g}_\lambda \circ (H_t \times \text{Id})^{-1}: D^2 \times T_\lambda^3 \rightarrow D^2 \times T_\lambda^3.$$

This is an isotopy on $D^2 \times T_\lambda^3$ with G_0 the identity and with G_1 arbitrarily close to the identity.

Now by the local path connectedness of $\text{Homeo}_\partial(D^2 \times T_\lambda^3)$ (Theorem 19.1), G_1 is isotopic to the identity, which implies that g_λ is isotopic to the identity. \square

The argument from above then allows us, for λ coming from Lemma 23.19, to improve f'_λ to $h_\lambda: M_\lambda \xrightarrow{\cong} I^3 \times T^3$, a homeomorphism (not a PL homeomorphism), with

$$f_\lambda|_\partial = h_\lambda|_\partial: \partial M_\lambda \rightarrow \partial I^3 \times T_\lambda^3.$$

Also f_λ is homotopic to h_λ by Lemma 23.18. Therefore indeed

$$[(M, f)] = [(M_\lambda, f_\lambda)] \in \mathcal{S}_{\text{PL}}^*(I^3 \times D^3, \partial)$$

is in the image of $\theta: \text{PL}(D^3 \times T^3, \partial) \rightarrow \mathcal{S}_3^*(D^3 \times T^3, \partial)$, as desired. \square

This concludes our computation of the homotopy type of TOP / PL, and of the homotopy groups of TOP / O.

Concordance implies isotopy

Mark Powell

First we will prove CAT handle straightening, then we will apply it to prove the concordance implies isotopy theorem. Most of the work is in proving the handle straightening theorem.

24.1. CAT handle straightening

Consider a topological embedding $h: B^k \times \mathbb{R}^n \hookrightarrow V_{\text{CAT}}^{k+n}$ which is a CAT embedding near $(\partial B^k) \times \mathbb{R}^n$. Then we say handle h can be (PL-)straightened/smoothed if there exists an isotopy $h_t: B^k \times \mathbb{R}^n \hookrightarrow V^{k+n}$ such that

- (1) $h_0 = h$;
- (2) h_1 is a CAT embedding near $B^k \times B^n$;
- (3) $h_t = h$ for $t \in [0, 1]$ outside a compact set and near $(\partial B^k) \times \mathbb{R}^n$.

We will show that handles can be straightened assuming that a handle problem is concordant to a solution, and in fact this will imply that an entire concordance can be straightened.

Recall that for M a manifold with boundary, the symbol $\sqsupset (I \times M)$, sometimes just called \sqsupset , denotes the edges $I \times \partial M \cup \{1\} \times M$. The next theorem and its proof are from [KS77b, Essay I.3].

THEOREM 24.1. *Let X be a CAT manifold and $h: I \times B^k \times \mathbb{R}^n \rightarrow X$ a (TOP) homeomorphism, and a CAT embedding near \sqsupset . Suppose $m := k + n \geq 5$. Then there is an isotopy*

$$h_t: I \times B^k \times \mathbb{R}^n \rightarrow X, \quad t \in [0, 1]$$

such that $h_0 = h$, and h_1 a CAT embedding near $I \times B^k \times B^n$, and there is $r > 0$ such that for all $t \in [0, 1]$ we have $h_t = h$ near \sqsupset and outside $I \times B^k \times rB^n$.

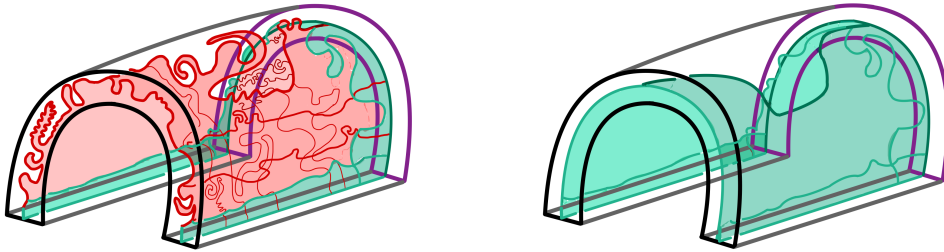

FIGURE 24.1. The given h is already a CAT embedding on the green region. After an isotopy we obtain h_1 which is also CAT near the blue region $I \times B^k \times B^n$.

Recall that we did handle straightening for TOP, where the condition was that a handle was “close” to a straightened one. Now we have PL/DIFF structures and the condition is given by a concordance instead.

Proof. Let us fix some notation, similarly as for the previous torus trick. Let $\rho: \mathbb{R}^n \rightarrow T^n$ be the standard covering and define

$$\begin{aligned} \bar{e}: \mathbb{R}^n &\rightarrow T^n \\ y &\mapsto \rho(y/8). \end{aligned}$$

Let $p := \bar{e}(1/2, \dots, 1/2)$ and pick a CAT immersion $\alpha': T^n \setminus \{p\} \looparrowright \mathbb{R}^n$. As before, we can arrange that $\alpha' \circ \bar{e}|_{2B^n} = \text{Id}_{2B^n}$. Let i, i_1 be such that the diagram in Fig. 24.2 commutes. We

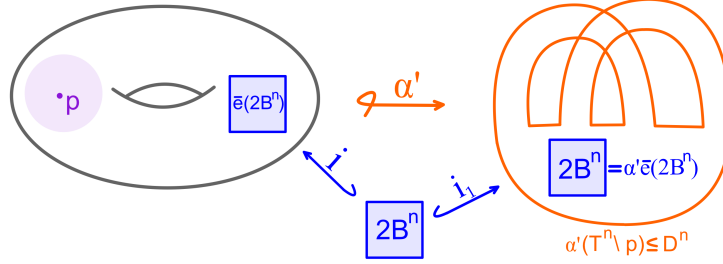

FIGURE 24.2. An immersion of the n -torus.

can choose α' carefully so that the immersion

$$\alpha := \text{Id}_{I \times B^k} \times \alpha': I \times B^k \times T^n \setminus \{p\} \looparrowright I \times B^k \times \mathbb{R}^n$$

is one-to-one on the preimage of $i(I \times B^k \times 2\mathring{B}^n)$. This will imply that i_3 in the diagram below is a CAT embedding. Finally, define $e := \text{Id}_{I \times B^k} \times \bar{e}: I \times B^k \times \mathbb{R}^n \rightarrow I \times B^k \times \mathbb{R}^n$.

The aim is to construct the following diagram.

$$\begin{array}{ccc} [I \times B^k \times \mathbb{R}^n]_{\Sigma_4} & \xrightarrow[\cong_{\text{CAT}, \text{Id}_{\text{near } \square, \infty}}]{H} & [I \times B^k \times \mathbb{R}^n]_{\text{std}} \\ \uparrow \text{CAT emb. on } \text{Im}(i_3) \quad j & \downarrow I \times B^k \times B^n \subseteq H(I \times B^k \times 2\mathring{B}^n) & \uparrow \text{radial compression} \\ [I \times B^k \times \mathbb{R}^n]_{\Sigma_3} & \xrightarrow[\cong_{\text{CAT}, \text{Id}_{\text{near } \square} \text{ bded dist. from Id}}]{G} & [I \times B^k \times \mathbb{R}^n]_{\text{std}} \\ \uparrow \text{CAT cover } e & & \downarrow e \\ [I \times B^k \times T^n]_{\Sigma_2} & \xrightarrow[\cong_{\text{CAT}, \text{Id}_{\text{near } \square}}]{g} & [I \times B^k \times T^n]_{\text{std}} \\ \uparrow \text{CAT emb. on } \text{Im}(i_1) & & \downarrow \\ [I \times B^k \times 2\mathring{B}^n]_{\Sigma} & \xleftarrow{i_1} & [I \times B^k \times T^n \setminus \{p\}]_{\Sigma_1} \\ \uparrow \text{CAT immersion } \alpha & & \downarrow \alpha \\ [I \times B^k \times \mathbb{R}^n]_{\Sigma} & \xrightarrow[\cong_{\text{CAT}}]{h} & X \end{array}$$

Curved arrows: i_4 from $[I \times B^k \times \mathbb{R}^n]_{\Sigma_4}$ to $[I \times B^k \times 2\mathring{B}^n]_{\Sigma}$; i_3 from $[I \times B^k \times \mathbb{R}^n]_{\Sigma_3}$ to $[I \times B^k \times 2\mathring{B}^n]_{\Sigma}$; i from $[I \times B^k \times \mathbb{R}^n]_{\Sigma}$ to X .

- (1) Let Σ be the CAT structure on $I \times B^k \times \mathbb{R}^n$ obtained by pulling back the CAT structure on X via h . This induces a CAT structure on $I \times B^k \times 2\mathring{B}^n$, which we also label Σ . The map i is the inclusion map.

- (2) Define a CAT structure Σ_1 on $I \times B^k \times T^n \setminus \{p\}$ so that α is a CAT immersion with respect to Σ . Since we use Σ to obtain Σ_1 , in a sense it was not important that α was originally a CAT map with respect to the standard structures. We now choose the CAT structure on the domain to make α a CAT immersion.
- (3) The CAT structure Σ_2 comes from extending Σ_1 on a subset away from the missing point in T^n . As before we have to use the Schoenflies theorem, and the non-compact h -cobordism theorem. This uses the dimension restriction that $k + n \geq 5$. We postpone the details of this until later in the proof.
- (4) The cobordism

$$[(I; \{0\}, \{1\}) \times B^k \times T^n]_{\Sigma_2}$$

is topologically a product, but a priori we do not know that it is a CAT product. But the CAT s -cobordism theorem (recall $\text{Wh}(\mathbb{Z}[\mathbb{Z}^n]) = 0$) shows that there is a CAT isomorphism g , which is the identity near \sqcap . This again used the dimension restriction $k + n \geq 5$.

This is where the I coordinate helps. Recall that at the analogous stage in the proof of the stable homeomorphism theorem, we had to lift to a finite cover and apply the classification of homotopy tori. That will not work here, since we want to also be able to straighten 3-handles. But we have the extra hypothesis of a concordance to a straightened handle, and we use it crucially here.

- (5) Define G to be the lift of g along e . Define Σ_3 so that G is a CAT isomorphism. Since $Ge = eg$ and g, G , and the right hand e are all CAT maps, so is the left hand e . Note that since g is homotopic to the identity, G is bounded distance from the identity.
- (6) The maps i_3 and i_4 are the natural inclusion maps. The fact that $\alpha' \circ \bar{e}|_{2B^n} = \text{Id}_{2B^n}$ implies that i_3 is a CAT embedding.
- (7) Define the map j to be a radial compression fixing $I \times B^k \times 2B^n$ pointwise, a homeomorphism onto its image $I \times B^k \times rB^n$ for some $r > 0$. Since j does not change $I \times B^k \times 2B^n$, it follows that i_4 is a CAT embedding.
- (8) Choose a map

$$\beta: [I \times B^k \times \mathbb{R}^n]_{\Sigma_3} \rightarrow [I \times B^k \times \mathbb{R}^n]_{\Sigma_3}$$

such that $G \circ \beta(I \times B^k \times 2B^n) \supseteq I \times B^k \times B^n$ fixing \sqcap and near ∞ . So $G' := G \circ \beta$ equals G near ∞ and equals Id near \sqcap . Also $G'(I \times B^k \times 2\mathring{B}^n) \supseteq I \times B^k \times B^n$.

- (9) Define

$$H := \begin{cases} jG'j^{-1} & \text{on } j(I \times B^k \times \mathbb{R}^n) = I \times B^k \times r\mathring{B}^n, \\ \text{Id} & \text{else.} \end{cases}$$

We use that G is bounded distance from the identity to see that $jG'j^{-1}$ limits to Id on $I \times B^k \times rS^n$, and we may therefore extend it by the identity.

- (10) Choose Σ_4 to make H a CAT isomorphism.

This finishes the construction of the diagram, apart from the construction of Σ_2 . We give some details on this now. Recall that we have a structure Σ_1 on $I \times B^k \times (T^n \setminus \{p\})$. Our aim is to construct a CAT structure Σ_2 on $I \times B^k \times T^n$ that is standard near \sqcap , and such that

$$[I \times B^k \times (T^n \setminus \{p\})]_{\Sigma_1} \rightarrow [I \times B^k \times T^n]_{\Sigma_2}$$

is a CAT embedding near $i_1(I \times B^k \times 2B^n)$.

First, for some $\lambda < 1$, extend Σ_1 from $I \times B^k \times (T^n \setminus \{p\})$ to $(I \times B^k \times T^n) \setminus (I \times \lambda B^k \times \{p\})$. The structure is already standard near $I \times \partial B^k \times \{p\}$, so we can extend in this way. We also call the extension also Σ_1 . Choose an embedding

$$\psi: (I \times B^k \times T^n) \setminus (I \times \{0\} \times \{p\}) \hookrightarrow (I \times B^k \times T^n) \setminus (I \times \lambda B^k \times \{p\})$$

that is the identity outside a neighbourhood of $I \times \lambda B^k \times \{p\}$. Note that $B^k \setminus \lambda B^k \cong B^k \setminus \{0\}$, so such an embedding exists. Define

$$\Sigma'_1 := \psi^{-1}(\Sigma_1).$$

This CAT structure has changed nothing on $i_1(I \times B^k \times 2B^n)$, nor near \sqcap . So we just need to extend it to some compatible CAT structure on all of $I \times B^k \times T^n$.

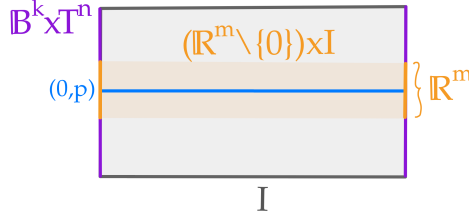

FIGURE 24.3. Construction of Σ_2 .

Recall that $m := k + n$, and consider $I \times B^k \times T^n$ as $(B^k \times T^n) \times I$. Consider an \mathbb{R}^m neighbourhood of $(0, p)$ in $B^k \times T^n$. Then $(\mathbb{R}^m \setminus \{0\}) \times I$ inherits a CAT structure from Σ'_1 , which we also call Σ'_1 , and it suffices to extend this over all of $\mathbb{R}^m \times I$. Now

$$[\mathbb{R}^m \times I \setminus (\{0\} \times I)]_{\Sigma_1}$$

is a CAT non-compact proper h -cobordism. (Here proper means that the inverse image of each compact set is compact). The proper h -cobordism theorem gives a proper CAT isomorphism

$$\phi: [\mathbb{R}^m \times I \setminus (\{0\} \times I)]_{\Sigma_1} \xrightarrow{\cong_{\text{CAT}}} [\mathbb{R}^m \times I \setminus (\{0\} \times I)]_{\Sigma_{\text{std}}}$$

that restricts to the identity on $(\mathbb{R}^m \setminus \{0\}) \times \{1\}$, where Σ'_1 was already standard. Let

$$C := I \times \frac{1}{2} B^m.$$

Extend ϕ by $(0, 0) \mapsto (0, 0)$ and $(0, 1) \mapsto (1, 1)$. The resulting ϕ is then a homeomorphism and $\phi(\partial C)$ is a sphere S^m . By the Schoenflies Theorem 6.19, $\phi(\partial C)$ bounds a topological ball B^{m+1} in $\mathbb{R}^m \times I$. Extend ϕ over that ball by coning. Then we obtain a homeomorphism

$$\Phi: \mathbb{R}^m \times I \rightarrow \mathbb{R}^m \times I$$

that is a CAT embedding outside $sB^m \times I$, where $s > 0$ is large enough to encompass both C and $\phi(C)$. Then

$$\sigma := \Phi^{-1}(\Sigma_{\text{std}})$$

gives a CAT structure on $\mathbb{R}^m \times I$ that agrees with Σ'_1 outside $sB^m \times I$. Patching together Σ'_1 and σ , which we can do since they agree on the open set $(\mathbb{R}^m \times I) \setminus (sB^m \times I)$ of $\mathbb{R}^m \times I$, we obtain the desired structure Σ_2 on all of $I \times B^k \times T^n$. As promised we have that Σ_2 is standard near \sqcap , and the inclusion

$$[I \times B^k \times (T^n \setminus \{p\})]_{\Sigma_1} \rightarrow [I \times B^k \times T^n]_{\Sigma_2}$$

is a CAT embedding near $i_1(I \times B^k \times 2B^n)$. This completes the construction of Σ_2 , which was the only part missing in the construction of the main diagram in the enumerated list above.

Now we use the diagram to complete the proof. We use the existence of the CAT-isomorphism H with the properties shown in the diagram, namely that it is Id near \sqcap and near ∞ , and that $I \times B^k \times B^n \subseteq H(I \times B^k \times 2\dot{B}^n)$. We also use that $\Sigma = \Sigma_4$ on $I \times B^k \times 2\dot{B}^n$.

Extend H by Id to homeomorphism of $[0, \infty) \times \mathbb{R}^{n+k}$. Then let $H_t: I \times B^k \times \mathbb{R}^n \rightarrow I \times B^k \times \mathbb{R}^n$ be an Alexander isotopy of homeomorphisms defined by

$$H_t(x) := \begin{cases} tH(\frac{x}{t}) & 0 < t \leq 1, \\ H_0(x) = x & \end{cases}$$

Finally, define

$$h_t := h \cdot H_t^{-1}$$

We have $h_0 = h$ and $h_1 = hH^{-1}$, and

$$h_t: I \times B^k \times \mathbb{R}^n \xrightarrow{H^{-1}} [I \times B^k \times \mathbb{R}^n]_{\Sigma_4} \xrightarrow{\text{Id}} [I \times B^k \times \mathbb{R}^n]_{\Sigma} \xrightarrow{h} X$$

Since $H^{-1}(I \times B^k \times B^n) \subseteq [I \times B^k \times 2\mathring{B}^n]_{\Sigma_4}$ and $\Sigma = \Sigma_4$ on $I \times B^k \times 2\mathring{B}^n$, we have that h_1 is a CAT embedding on $I \times B^k \times B^n$. Note that the map h from the hypotheses was used to define the various CAT structures, starting with Σ , as well as in the final step of the proof. \square

24.2. Proof of concordance implies isotopy

Next, as promised we shall prove that concordance implies isotopy for CAT structures Theorem 22.5. Here is the technical relative version we will prove, see Fig. 24.4.

THEOREM 24.2 (Concordance implies isotopy, relative version). *Let M^m be a topological manifold with a CAT structure Σ , and pick closed subsets $C \subseteq M$ and $D \subseteq M$, and open neighbourhoods $U \supseteq C$ and $V \supseteq D \setminus C$. We need $m \geq 6$ or $m = 5$ and $\partial M \subseteq U$.*

Let Γ be a CAT structure on $M \times I$ such that $\Gamma = \Sigma \times [0, \delta)$ near $M \times \{0\}$ and $\Gamma = \Sigma \times I$ on $U \times I$. Fix a continuous function $\varepsilon: M \times I \rightarrow (0, \infty]$.

Then there exists an isotopy

$$h_t: M \times I \rightarrow M \times I, \quad t \in [0, 1]$$

such that

- (1) $h_0 = \text{Id}_{M \times I}$,
- (2) $h_1: M_{\Sigma} \times I \rightarrow (M \times I)_{\Gamma}$ is a CAT embedding near $(C \cup D) \times I$,
- (3) h_t fixes a neighbourhood of $(M \setminus V) \times I \cup M \times \{0\} \cup C \times I$,
- (4) $d(h_t(x), x) < \varepsilon(x)$ for all $x \in M \times I$ and $t \in [0, 1]$.

This is known as a ‘‘CUDV’’ theorem, which is a colloquialism for a relative statement. The roles of C , U , D , and V are as follows. There is a solution on C that we want to maintain. If the solution can be extended to U , we can solve the problem on D whilst keeping the given solution on C , and not changing anything outside V . This version with precise control, in terms of CUDV and ε is what we will use in the proof of the product structure theorem. The fact that handle straightening allows us to work handle by handle means that achieving the control we desire is fairly straightforward.

Taking $C = U = \emptyset$, $D = V = M$, and $\varepsilon \equiv \infty$ yields the special case with $\partial M = \emptyset$ that was stated before as Theorem 22.5.

Proof. We have already done the hard work in proving Theorem 24.1. Relabel $I \rightarrow I$ by sending $t \mapsto 1 - t$, so it will be easier to apply handle straightening, as shown in Fig. 24.4.

First we triangulate V using the CAT structure. Convert to a handle structure – remember that triangulations give PL handle decompositions. If CAT=DIFF we can use Morse theory directly, and need not first obtain a triangulation. Make the handle structure fine enough so that every handle that touches C is contained in U . This might require subdividing.

Let

$$K := \{\text{handles of } K \text{ contained in } U\}$$

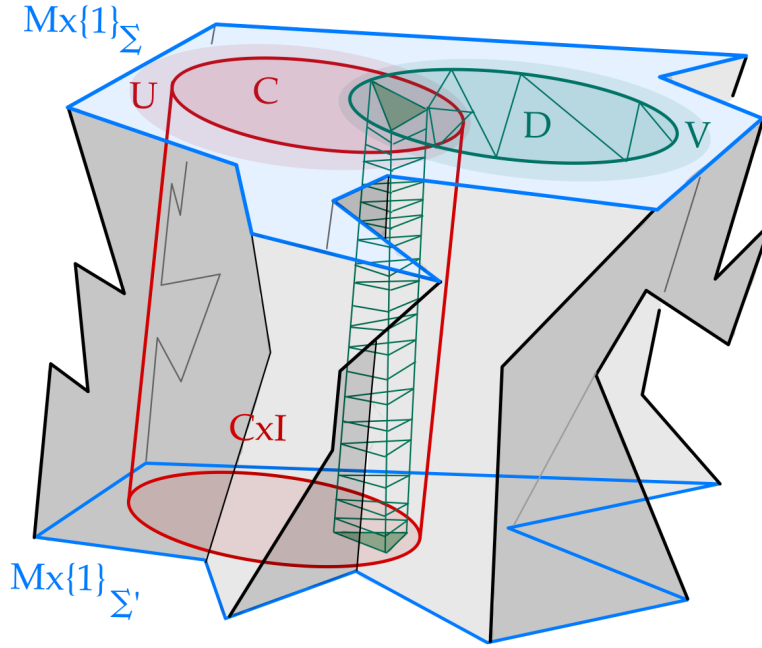

FIGURE 24.4. The setup of the relative version of concordance implies isotopy.

and let

$$L := \{\text{handles of } V \text{ that meet } D \setminus C\}.$$

Note that

$$K \cup L \supseteq (C \cup D) \cap V.$$

Induct on handles in L . Start with handles whose attaching region is contained in U , and straighten handles in the order in which they are attached. As we isotope a handle, we shall also move subsequent handles that we have not yet straightened, which are attached to the handle we are straightening.

Extend each handle $B^k \times B^n$ with $n = m - k$ to $B^k \times \mathbb{R}^n \subseteq V$, and apply the handle straightening Theorem 24.1 to the identity map

$$\text{Id}: I \times B^k \times \mathbb{R}_{\text{std}}^n \rightarrow [I \times B^k \times \mathbb{R}^n]_{\Gamma}.$$

The structure Γ agrees with Σ on $M \times \{1\}$, and we fix it by isotopy to agree with $\Sigma \times I$ on $I \times B^k \times B^n$. If necessary first subdivide the decomposition further to make the handle decomposition fine enough, with respect to ε , to arrange that $d(h_t(x), x) < \varepsilon(x)$ for all x, t . \square

The product structure theorem

Mark Powell

We now prove the product structure theorem. This will use the technical relative version of concordance implies isotopy. Before we begin, we also need one more ingredient, about CAT structures on Euclidean space. This uses a result of Browder-Levine-Livesay on CAT-manifolds, and the stable homeomorphism theorem.

25.1. CAT structures on Euclidean spaces

THEOREM 25.1 (Stallings [Sta62a]). *Any two CAT structures on \mathbb{R}^n are isotopic for $n \geq 6$.*

We have already stated this result as a corollary of the Product Structure Theorem 22.8, but we will actually use it in its proof, so certainly we need an independent argument. The original proof due to Stallings uses engulfing for a PL proof, which works for $n \geq 5$. Then the deduction from PL to smooth goes via the PL-to-smooth smoothing theory. But we present a different proof, which works only for $n \geq 6$ (but this will be enough). The proof we will give has the advantage that if one wants the smooth version, there is a more directly smooth proof. It uses the following ingredient.

THEOREM 25.2 (Browder-Levine-Livesay [BLL65]). *Let X be an open CAT (PL or DIFF) n -manifold with $n \geq 6$, which is simply connected at infinity and H_*X are finitely generated.*

Then X is CAT isomorphic to the interior of a compact manifold Y with simply connected boundary. Moreover, such Y is unique.

Proof of Theorem 25.1. Let Σ be a CAT structure on \mathbb{R}^n . By Theorem 25.2, we have that $\mathbb{R}_\Sigma^n \cong \text{Int } W$ for some compact manifold W with $\pi_1(\partial W)$ trivial.

Recall that a manifold is homotopy equivalent to its interior. Then a homology computation implies that $\partial W \simeq S^{n-1}$. To see this, we have an exact sequence of homology with \mathbb{Z} coefficients

$$H_{k+1}(W, \partial W) \rightarrow H_k(\partial W) \rightarrow H_k(W).$$

For $k \geq 1$, $H_k(W) = 0$. Also $H_{k+1}(W, \partial W) \cong H^{n-k-1}(W) = 0$ for $n - k - 1 > 0$, that is $k < n - 1$. Therefore $H_k(\partial W) = 0$ for $1 \leq k \leq n$. For $k = n - 1$ we have $H_{n-1}(\partial W) \cong H_n(W, \partial W) \cong H^0(W) \cong \mathbb{Z}$. The Hurewicz theorem and Whitehead's theorem then imply that $\partial W \simeq S^{n-1}$ as claimed.

Also, $W \setminus \overset{\circ}{D}^n$, for a small ball D^n in the interior, is an h -cobordism from ∂W to S^{n-1} . Thus, we have that they are CAT isomorphic by the h -cobordism theorem (this uses $n \geq 6$).

We can glue a disc D^m to W in such a way that $W \cup_{\partial W} D^m$ is CAT isomorphic to S^n . In the smooth category this needs some care, since gluing two discs together can also produce exotic spheres. But we make the choice that yields the standard sphere. We view $S^n = \partial D^{n+1}$, and this gives an h -cobordism from W to D^m . Therefore, by the CAT h -cobordism theorem there is a CAT isomorphism $D^m \rightarrow W$, which on the interior restricts to a CAT isomorphism

$$\Theta: \mathbb{R}_{\text{std}}^n \rightarrow \mathbb{R}_\Sigma^n.$$

By the Stable Homeomorphism Theorem, or more precisely Theorem 17.27, Θ is TOP isotopic to Id, therefore Σ is isotopic to the standard structure. \square

25.2. The proof of the product structure theorem

First we recall the statement of concordance implies isotopy, since we will need it here a couple of times.

THEOREM 25.3 (Concordance implies isotopy, relative version). *Let M^m be a topological manifold with a CAT structure Σ , and pick closed subsets $C \subseteq M$ and $D \subseteq M$, and open neighbourhoods $U \supseteq C$ and $V \supseteq D \setminus C$. We need $m \geq 6$ or $m = 5$ and $\partial M \subseteq U$.*

Let Γ be a CAT structure on $M \times I$ such that $\Gamma = \Sigma \times [0, \delta)$ near $M \times \{0\}$ and $\Gamma = \Sigma \times I$ on $U \times I$. Moreover, fix a continuous function $\varepsilon: M \times I \rightarrow (0, \infty]$.

Then there exists an isotopy

$$h_t: M \times I \rightarrow M \times I, \quad t \in [0, 1]$$

such that

- (1) $h_0 = \text{Id}_{M \times I}$,
- (2) $h_1: M_\Sigma \times I \rightarrow (M \times I)_\Gamma$ is a CAT embedding near $(C \cup D) \times I$,
- (3) h_t fixes a neighbourhood of $(M \setminus V) \times I \cup M \times \{0\} \cup C \times I$,
- (4) $d(h_t(x), x) < \varepsilon(x)$ for all $x \in M \times I$ and $t \in [0, 1]$.

Here is the version of the product structure theorem we are going to prove. Where notation overlaps between the statement of this theorem and the statement of the previous theorem, ignore it. In the course of the proof of the product structure theorem we will apply Concordance implies Isotopy twice, with different subsets playing the role of C, U, D , and V .

THEOREM 25.4 (Relative Product Structure Theorem). *Let M be a manifold and fix an open subset $U \subseteq M$. Assume $\dim M \geq 6$, or $\dim M = 5$ with $\partial M \subseteq U$. Let Σ be a CAT structure on $M \times \mathbb{R}^q$ for some $q \geq 1$, and suppose there exists a CAT structure ρ on U with $\Sigma|_{U \times \mathbb{R}^q} = \rho \times \mathbb{R}^q$.*

Then ρ extends to a CAT structure σ , and there is a concordance $(M \times \mathbb{R}^q \times I)_\Gamma$ from Σ to $(M \times \mathbb{R}^q)_{\sigma \times \mathbb{R}^q}$ relative to $U \times \mathbb{R}^q$. Moreover, any two such structures σ on M are unique up to concordance.

We will use the stable homeomorphism theorem, the uniqueness of CAT structures on \mathbb{R}^m for $m \geq 6$ up to isotopy, Theorem 25.3 that concordance implies isotopy, and a new lemma called the Windowblind Lemma, which we will explain when the time comes.

Proof. First we observe that it suffices to prove the case of $q = 1$, by induction. Also we can work chart by chart, since we have a relative theorem. We will also ignore the boundary for brevity. So we can assume that $M = \mathbb{R}^m$. Then for the general case this will play the role of a single chart in the induction.

Since $m \geq 5$, we have that $\dim(M \times \mathbb{R}) \geq 6$. Then we know that Σ is isotopic (and therefore concordant) to the standard structure on \mathbb{R}^{m+1} (recall we are assuming that $M = \mathbb{R}^m$). However, this is not relative to $U \times \mathbb{R}$, so we still have work to do. The first step is to apply Theorem 25.3 with $U = C = \emptyset$, $D = M \times [1, \infty)$, $V = M \times (\frac{1}{2}, \infty)$. Then we obtain an isotopy from Σ to a structure Σ_1 , where Σ_1 equals the standard structure on $M \times [1, \infty)$, so is a product structure there, and equals Σ on $M \times (-\infty, 0]$.

For the next step, on $U \times [0, 1]$, we have a CAT structure $\Sigma_1|_{U \times [0, 1]}$. Let $\varepsilon: M \times [0, 1] \rightarrow [0, \infty)$ be a continuous function with $\varepsilon^{-1}((0, \infty)) = U \times [0, 1]$ (this is potentially confusing, in Theorem 25.3 the codomain of ε was $(0, \infty)$, but this is not a problem, since we will only apply it to $U \times [0, 1]$). Next apply Theorem 25.3 to $U \times [0, 1]|_{\Sigma_1}$, setting $C = U = \emptyset$ (where the U comes from Theorem 25.3), and $V = D = U$ (where U comes from the current statement). We obtain an isotopy $h_t: U \times [0, 1]$ from Id to h_1 where $h_1: U \times [0, 1]_{\rho \times [0, 1]} \rightarrow U \times [0, 1]_{\Sigma_1}$.

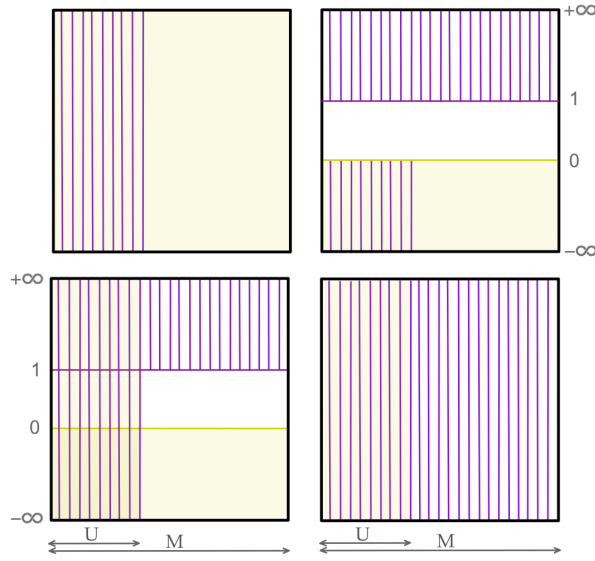

FIGURE 25.1. Proof of the product structure theorem. Each square depicts $M = \mathbb{R}^m$ as the horizontal axis, with $U \subseteq M$ a subset of it, while the \mathbb{R} coordinate corresponds to the vertical axis. In each square, vertical lines indicate that the structure there is a product structure. Shaded yellow indicates that the structure coincides with Σ on that region. The top left square shows Σ , where we start. The top right shows Σ_1 . The bottom left square depicts Σ_2 . The bottom right shows the goal, $\sigma \times \mathbb{R}$, which agrees with Σ on $U \times \mathbb{R}$.

Extend h_1 to a homeomorphism $h: M \times \mathbb{R} \rightarrow M \times \mathbb{R}$ by setting

$$(x, r) \mapsto \begin{cases} (x, r) & r \leq 0 \\ h_1(x, r) & (x, r) \in U \times [0, 1] \\ (\text{pr}_1(h_1(x, 1)), r) & x \in U, r \geq 1 \\ (x, r) & x \notin U \end{cases}$$

where pr_1 is the projection $U \times \{1\} \rightarrow U$. Then define Σ_2 such that $h: [M \times \mathbb{R}]_{\Sigma_2} \rightarrow [M \times \mathbb{R}]_{\Sigma_1}$ is a CAT isomorphism. The structure Σ_2 now has the property that it is still a product on $M \times [1, \infty)$, and equals Σ on $M \times (-\infty, 0]$, but now it also equals Σ on $U \times \mathbb{R}$, and is therefore also a product structure $\rho \times \mathbb{R}$ on $U \times \mathbb{R}$.

To finish off the proof, we need the next lemma.

LEMMA 25.5 (Windowblind lemma). *Let Σ' and Σ'' be CAT structures on $M \times \mathbb{R}$. Suppose that $\Sigma' = \Sigma''$ on $M \times (a, b)$ for some $-\infty \leq a < b \leq \infty$ and both Σ' and Σ'' are products on $U \times \mathbb{R}$. Then there exists a concordance from Σ' to Σ'' relative to $U \times \mathbb{R}$.*

Proof. Choose an isotopy of embeddings $h_t: \mathbb{R} \rightarrow \mathbb{R}$ with $h_0 = \text{Id}_{\mathbb{R}}$ and $h_1: \mathbb{R} \rightarrow (a, b)$ an onto embedding. Define

$$H: I \times M \times \mathbb{R} \rightarrow I \times M \times \mathbb{R} \\ (t, x, r) \mapsto (t, x, h_t(r)) =: H_t(x, r).$$

Then $H^{-1}(I \times \Sigma')$ is a structure on $I \times M \times \mathbb{R}$ so that $H: [I \times M \times \mathbb{R}]_{H^{-1}(I \times \Sigma')} \rightarrow [I \times M \times \mathbb{R}]_{I \times \Sigma'}$ is a CAT embedding.

Then $[I \times M \times \mathbb{R}]_{H^{-1}(I \times \Sigma')}$ is a concordance from Σ' to $H_1^{-1}(\Sigma')$ relative to $U \times \mathbb{R}$, since Σ' is already a product on $U \times \mathbb{R}$. Similarly, there exists a concordance from Σ'' to $H_1^{-1}(\Sigma'')$.

But $\Sigma' = \Sigma''$ on $M \times (a, b)$, so we know that $H_1^{-1}(\Sigma') = H_1^{-1}(\Sigma'')$ as structures on $M \times \mathbb{R}$, and therefore Σ' is concordant to Σ'' relative to $U \times \mathbb{R}$. \square

Returning to the proof of the product structure theorem, choose some $r \in (1, \infty)$ and let σ be the CAT structure on $M \times \{r\}$, with $(a, b) \subseteq (1, \infty)$. Apply the Windowblind lemma to Σ_2 and $\sigma \times \mathbb{R}$ to get a concordance form Σ_2 to $\sigma \times \mathbb{R}$.

Next apply the lemma to Σ and Σ_2 with $(a, b) \subseteq (-\infty, 0)$ to get a concordance from Σ to Σ_2 relative to $U \times \mathbb{R}$.

Putting these together we get the desired concordance from Σ to $\sigma \times \mathbb{R}$. This completes the proof in the case that $M = \mathbb{R}^m$ and $q = 1$. As stated at the start of the proof, this is sufficient by an induction over charts and over q .

The product structure theorem also included the statement that any two such CAT structures σ and σ' on M arising in this way are unique up to concordance. We did not prove this yet, so let us do so now. We have concordances

$$\sigma \times \mathbb{R}^q \sim \Sigma \sim \sigma' \times \mathbb{R}^q$$

relative to $U \times \mathbb{R}^q$. Gluing them together gives a CAT structure Γ on $I \times M \times \mathbb{R}^q$, between $\sigma \times \mathbb{R}^q$ and $\sigma' \times \mathbb{R}^q$, and we extend it to a CAT structure, also called Γ , on $\mathbb{R} \times M \times \mathbb{R}^q$. We may assume that the concordance is *conditioned*, i.e. it is a product near $\{i\} \times M \times \mathbb{R}^q$ for $i = 0, 1$, so that it can be extended over $\mathbb{R} \times M \times \mathbb{R}^q$. Let

$$U' \times \mathbb{R}^q := ((\mathbb{R} \setminus [1/4, 3/4]) \times M \times \mathbb{R}^q) \cup (\mathbb{R} \times U \times \mathbb{R}^q).$$

Since Γ is conditioned, we may isotope Γ to a CAT structure that is a product $\mathbb{R} \times \theta \times \mathbb{R}^q$ on $U' \times \mathbb{R}^q$.

Apply the product structure theorem with $U' \subseteq \mathbb{R} \times M$, the CAT structure $\Gamma|_{U' \times \mathbb{R}^q} = \mathbb{R} \times \theta \times \mathbb{R}^q$ on U' , and the CAT structure Γ on $\mathbb{R} \times M \times \mathbb{R}^q$. It yields a product CAT structure $\gamma \times \mathbb{R}^q$ on $\mathbb{R} \times M \times \mathbb{R}^q$ which agrees with the CAT structure $\mathbb{R} \times \theta \times \mathbb{R}^q$ on $U' \times \mathbb{R}^q$. In particular $\gamma \times \{0\}$ is a CAT structure on $\mathbb{R} \times M$ that extends $\mathbb{R} \times \theta$ on U' . Restricting to $I \times M$, γ gives a concordance between σ and σ' , as desired. \square

25.3. Recap of PL-ing and Smoothing theory

Now that we have proven the product structure theorem, it might help to recap its place in PL-ing and smoothing theory. Recall that one of the main questions we studied was whether a topological manifold M admits a CAT structure, where CAT stands for either PL or DIFF. We will discuss the case of $\partial M = \emptyset$ in this recap for simplicity.

The first observation was that smooth manifolds admit a tangent vector bundle. This motivated us to study the question of whether something analogous exists for purely topological manifolds. Back in Chapter 8 we learnt about the topological tangent microbundle $\mathfrak{t}_M = (M \rightarrow M \times M \rightarrow M)$. By Kister's Theorem (Theorem 8.10) we know that \mathfrak{t}_M is equivalent to a $\text{TOP}(n)$ -bundle, where $\text{TOP}(n) := \text{Homeo}_0(\mathbb{R}^n)$ is the group of homeomorphisms of \mathbb{R}^n fixing the origin. There is an analogous version for the PL category, which we did not cover.

We saw in Chapter 21 that $\text{TOP}(n)$ -bundles are stably classified by homotopy classes of maps $M \rightarrow B\text{TOP}$. We then studied the obstruction theory to lifting this map to $BCAT$, that

is, finding a map $M \rightarrow BCAT$, in the diagram

$$\begin{array}{ccc}
 & & BPL \\
 & \nearrow & \downarrow \\
 M & \longrightarrow & BTOP \\
 & & \downarrow \\
 & & B(TOP/CAT).
 \end{array}$$

Denote the lower map by $\delta: BTOP \rightarrow B(TOP/PL)$, where the latter space is defined by Theorem 21.13. Kirby-Siebenman proved (Theorem 22.19) that $TOP/PL \simeq K(\mathbb{Z}/2, 3)$. Since $B(TOP/PL)$ is a delooping of TOP/PL , we know that $B(TOP/PL) \simeq K(\mathbb{Z}/2, 4)$ so that $[M, B(TOP/PL)] \cong H^4(M; \mathbb{Z}/2)$ via a canonical map. The image of $\delta \circ \mathfrak{t}_M$ in $H^4(M; \mathbb{Z}/2)$ is by definition the *Kirby-Siebenmann invariant*. By obstruction theory, we know that it is the only obstruction to lifting \mathfrak{t}_M to BPL .

There are further obstructions to lifting \mathfrak{t}_M to $BDIFF$. The next potentially nontrivial obstruction lies in $H^8(M; \mathbb{Z}/28)$ corresponding to $\Theta_7 \cong \mathbb{Z}/28$. In order to see this, one should know the homotopy type of $B(TOP/O)$, which we described in Section 23.2.

Now, from the Precursor to smoothing theory (Section 9.3) we saw that having a lift $M \rightarrow BCAT$ implies that there is $q \geq 0$ such that $M \times \mathbb{R}^q$ admits a CAT structure. As before, we only showed this in the case of $CAT = DIFF$ but there is an analogue in the case of $CAT = PL$.

Finally, the Product Structure theorem (Theorem 22.8) tells us that if $n \geq 5$ and $\partial M = \emptyset$ then a CAT structure on $M \times \mathbb{R}^q$ can be used to equip M with a CAT structure. Observe that this is the first time we have had to restrict the dimension of M .

To summarise, via the product structure theorem, we know that the Kirby-Siebenmann invariant is the only obstruction to the existence of a PL structure on a closed topological manifold M with dimension ≥ 5 . There are further obstructions to the existence of a smooth structure, with the next potentially nontrivial obstruction lying in $H^8(M, \mathbb{Z}/28)$, and more generally in $H^{k+1}(M; \Theta_k)$ for $k \geq 7$.

Remark 25.6. Since we only needed to restrict dimensions in the final step where we applied the product structure theorem, there is still something we can say in the case of $n = 4$. Specifically, given a closed topological 4-manifold M , $ks(M) = 0$ then $M \times \mathbb{R}$ has a smooth (and therefore PL structure). However, there do exist nonsmoothable 4-manifolds with trivial Kirby-Siebenmann invariant, as follows. Let E_8 denote the E_8 manifold, constructed by Freedman [Fre82b]. Then $E_8 \# E_8$ does not admit a smooth structure (by Donaldson’s theorem) but has trivial Kirby-Siebenmann invariant.

Example 25.7. There exist non PL -able manifolds in each dimension at least 4. For example, let E_8 denote the E_8 manifold. Then $E_8 \times S^k$ for $k \geq 1$ does not admit a PL structure.

Example 25.8. Siebenmann showed that every orientable closed topological 5-manifold is triangulable. Consequently, $E_8 \times S^1$ is triangulable but not PL -able.

Example 25.9. There exist nontriangulable manifolds in each dimension at least 4. This was done by Freedman for $n = 4$ via the E_8 manifold and for $n \geq 5$ by Manolescu.

Example 25.10. There exist non- PL triangulations of PL manifolds. This follows since the double suspension of the Mazur homology sphere is S^5 as shown by Edwards and more generally by the double suspension theorem of Cannon [Can79a].

Example 25.11. There exist PL manifolds with no smooth structure. This was first shown by Kervaire in 1960 in dimension 10. The lowest possible dimension is 8, shown by Ells-Kuiper (1961).

A non-PL-able manifold

Ekin Ergen

26.1. Introduction and outline

The main goal of this document is to construct a topological manifold that admits no PL structure. We present a construction due to Siebenmann [KS77a]. An important step will be finding a PL automorphism $\alpha: D^2 \times T^n \rightarrow D^2 \times T^n$ that fixes boundary and satisfies certain properties. This automorphism will be used to create a TOP pseudoisotopy that Siebenmann referred to as a catastrophe, referencing French mathematician René Thom’s catastrophe theory in a broader context [Tho74]. Having this pseudoisotopy, it will be easy to show that a certain manifold admits no PL structure.

Finding such an automorphism is not only nontrivial, but will yield constructions of some exotic manifolds as a byproduct. In addition, we will mention another counterexample in Section 26.4 that followed almost a decade later, by an additional discovery due to Freedman.

26.2. Constructing an automorphism α

In this section, we follow [KS77b, Essay VI, Appendix B]. We will work in categories PL and DIFF, both of which we refer to as CAT as usual. The first goal is to come up with an explicit handle construction of an exotic manifold M that has analogous properties to α . This will allow us to create α , using the s -cobordism theorem on M that is regarded as an s -cobordism.

First, we want to recall some notions that define the ‘exoticity’ of a manifold. We shall start with the structure set.

Definition 26.1. The *structure set* $\mathcal{S}(M)$ of a manifold M^n is defined as the set of equivalence classes

$$(26.1) \quad \mathcal{S}(M) := \{(N^n, f: N \xrightarrow{\cong} M)\} / (h\text{-cobordism})$$

As we shall consider maps that fix boundary throughout the section, we want to restrict ourselves to manifolds that are homotopy equivalent to M relative to boundary. That is, we want the boundary (and also a collar neighbourhood of it) to be fixed by the homotopy equivalence h . Therefore it is natural to consider the notion

$$(26.2) \quad \mathcal{S}(M^n \text{ rel } \partial) := \{(N^n, f: N \xrightarrow{\cong} M) : f|_{\partial N \times [0,1]}: \partial N \times [0,1] \xrightarrow{\cong} \partial M \times [0,1]\} / (h\text{-cobordism})$$

where $\partial N \times [0,1]$ resp. $\partial M \times [0,1]$ are to be understood as collar neighbourhoods of N resp. M .

The following is our main theorem, in which we construct a manifold M homotopy equivalent to $D^3 \times T^n$.

THEOREM 26.2. *For $3 + n \geq 5$, there exists an element $[M^{3+n}, f]$ of $\mathcal{S}(D^3 \times T^n \text{ rel } \partial)$ that is*

- (1) *nontrivial, i.e. $[M] \neq [D^3 \times T^n]$;*

(2) invariant under passage to standard finite coverings of $D^3 \times T^n$.

We first elaborate on the structure set itself as well as the exact meaning of the second claim.

Remark 26.3. Using previous knowledge from lectures we can conclude that $\text{Wh}(\pi(D^3 \times T^n)) = \text{Wh}(\mathbb{Z}[\mathbb{Z}^n]) = 0$, so

$$\mathcal{S}(D^3 \times T^n \text{ rel } \partial) = \{(M, f)\} /_{(h\text{-cobordism})} \stackrel{\text{Wh}=0}{=} \{(M, f)\} /_{(s\text{-cobordism})} \stackrel{s\text{-cob. thm.}}{=} \{(M, f)\} /_{(\cong_{\text{CAT}})}$$

meaning that the elements of the specific structure set $\mathcal{S}(D^3 \times T^n)$ are CAT-isomorphism classes of homotopy equivalent $3 + n$ -manifolds rel boundary.

If $[(M, f)] = [(M', f')] \in \mathcal{S}(D^3 \times T^n \text{ rel } \partial)$, this means that there exists a CAT isomorphism $\varphi: M \rightarrow M'$ such that, restricting φ to ∂M , we obtain the commutative diagram

$$\begin{array}{ccccc}
 \partial M & \xrightarrow{f|_{\partial M}} & \partial(D^3 \times T^n) & & \\
 \downarrow \text{inc} & \searrow \varphi|_{\partial M} & \downarrow \text{inc}' & \searrow \text{Id} & \\
 \partial M' & \xrightarrow{f'|_{\partial M}} & D^3 \times T^n & & \\
 \downarrow \text{inc} & \downarrow \text{inc} & \downarrow \text{inc}' & & \\
 M & \xrightarrow{f} & D^3 \times T^n & & \\
 \searrow \varphi & \downarrow \text{inc} & \downarrow \text{Id} & \searrow \text{inc}' & \\
 M' & \xrightarrow{f'} & D^3 \times T^n & &
 \end{array}$$

Remark 26.4. In the second part of the theorem, we need to consider the pullback $\bar{p}: M' \rightarrow M$ of a covering map $p: D^3 \times T^n \rightarrow D^3 \times T^n$ along the homotopy equivalence $f: M \rightarrow D^3 \times T^n$ that comes from the tuple in the structure set, as shown in the next diagram.

$$\begin{array}{ccc}
 M' & \xrightarrow{f'} & D^3 \times T^n \\
 \downarrow \bar{p} & & \downarrow p \\
 M & \xrightarrow{f} & D^3 \times T^n
 \end{array}$$

The second part of the theorem claims that $[(M, f)] = [(M', f')] \in \mathcal{S}(D^3 \times T^n \text{ rel } \partial)$. The pullback of a covering map along any map is again a covering map, so the map $\bar{p}: M' \rightarrow M$ is indeed a covering map. Moreover, the pullback of a homotopy equivalence along a fibration (e.g. a covering map) is again a homotopy equivalence, so $f': M' \rightarrow D^3 \times T^n$ is also a homotopy equivalence. As a result, (M', f') defines an element in the structure set $\mathcal{S}(M^n \text{ rel } \partial)$.

The proof of Theorem 26.2 will be covered by the following three subsections. The construction is due to A. Casson.

26.2.1. Construction of M .

- (1) Recall the Poincaré homology 3-sphere P^3 : it is a closed manifold given by $SO(3)/A_5$, where A_5 denotes the rotational symmetry group of an icosahedron. This group is isomorphic to the alternating group on 5 elements. Therefore P can be interpreted as the group of the positions of a unit icosahedron up to translation and symmetry. As the name suggests, $H_n(P) = H_n(S^3)$ for all $n \in \mathbb{Z}$. The fundamental group $\pi_1(P)$ of P is isomorphic to the binary icosahedron group of order 120 given by the presentation

$$\langle a, b \mid (ab)^2 = a^3 = b^5 \rangle.$$

We will denote $\pi_1(P)$ by π . Note that, as an orientable 3-manifold, P is parallelisable.

- (2) Define $P_0^3 := P^3 \# D^3$. This is homeomorphic to the Poincaré homology 3-sphere minus an open ball, since the connected sum is created by removing a 3-ball from P^3 and D^3 each, the latter becoming an annulus $S^2 \times D^1$. This is glued onto $P^3 \setminus D^3$ along $S^2 \times \{0\}$, which only adds another collar to $P \setminus \overset{\circ}{D}^3$. The boundary of P_0 is $\partial P_0 = S^2$ as P is closed.
- (3) Take $[0, 1] \times P_0 \times D^n$. To $1 \times P_0 \times D^n$, we will attach handles that kill homotopy groups:
 - (a) We have $\pi_1(1 \times P_0 \times D^n) \cong \pi_1(P_0) \cong \pi_1(P^3) =: \pi$. The latter isomorphism follows by the Seifert-van Kampen Theorem for $D^3 \cup_{S^2 \times (-\varepsilon, \varepsilon)} P_0$. We can derive from the fibration $A_5 \rightarrow SO(3) \rightarrow P$ (where A_5 is a discrete Lie group) and its associated long exact sequence

$$\dots \rightarrow \underbrace{\pi_1(A_5)}_0 \rightarrow \pi_1(SO(3)) \rightarrow \pi_1(P) \rightarrow \pi_0(A_5) \rightarrow \underbrace{\pi_0(SO(3))}_0 \rightarrow \dots$$

we obtain the short exact sequence

$$(26.3) \quad 0 \rightarrow \pi_1(SO(3)) \xrightarrow{i} \pi \xrightarrow{p} A_5 \rightarrow 0.$$

We know that $\pi_1(SO(3)) \cong \mathbb{Z}/2$. Take an element γ of π that is not in the subgroup $i(\mathbb{Z}/2)$ and consider the smallest normal subgroup $\langle\langle \gamma \rangle\rangle$ that contains γ . We want to show that $\langle\langle \gamma \rangle\rangle = \pi$. Note that $p(\langle\langle \gamma \rangle\rangle)$ is a normal subgroup of A_5 . Because A_5 is simple, this image is either 0 or A_5 . Because $\gamma \notin i(\mathbb{Z}/2)$, $p(\gamma) \neq 0$ by exactness and therefore $i(\langle\langle \gamma \rangle\rangle) = A_5$. This implies that $[\pi : \langle\langle \gamma \rangle\rangle] \in \{1, 2\}$. If $[\pi : \langle\langle \gamma \rangle\rangle]$ were 2, then the sequence 26.3 would be split exact. This yields a map $s: \pi \rightarrow \mathbb{Z}/2$ such that $s \circ i = \text{Id}_{\mathbb{Z}/2}$. This induces maps between abelianisations $\mathbb{Z}/2 \xrightarrow{\bar{i}} \pi/[\pi, \pi] \xrightarrow{\bar{s}} \mathbb{Z}/2$ such that the composition is the identity. However, this is not possible: Using Hurewicz's Theorem, we see that $\pi/[\pi, \pi] \cong H_1(P) \cong H_1(S^3) = 0$. Therefore $[\pi : \langle\langle \gamma \rangle\rangle] = 1$ and $\pi = \langle\langle \gamma \rangle\rangle$.

We want to attach a 2-handle $h_2 (\cong D^2 \times D^{n+2})$ along this loop γ to make the resulting space simply connected. Up to homotopy, we have $||[S^1, SO(n+2)]|| = 2$ choices for the attaching map $S^1 \times D^{n+2} \rightarrow S^1 \times D^{n+2}$, where the S^1 -component of the target is the image of a loop representing γ . One of these choices indeed kills the fundamental group and gives rise to another parallelisable manifold: P_0 is parallelisable, as is $1 \times P_0 \times D^n$, so it has a trivial tangent bundle. Identifying this tangent bundle with the trivial tangent bundle of $\partial(D^2) \times D^{n+2}$ in a compatible way, we obtain another parallelisable manifold.

The resulting space is a simply connected CAT cobordism rel ∂ from $0 \times P_0 \times D^n$ to a simply connected CAT manifold Q . The homology of Q is the same as the homology of $D^{3+n} \# (S^2 \times S^{n+1})$, just as if P_0 were D^3 .

- (b) Now that one end of the cobordism is 1-connected, we want to achieve 2-connectivity. By 1-connectivity and Hurewicz's theorem,

$$\pi_2(Q) \cong H_2(Q) \cong H_2(D^{3+n} \# (S^2 \times S^{n+1})) \cong H_2(S^2 \times S^{n+1}) \cong \mathbb{Z}$$

so we can glue a 3-handle h_3 along a 2-sphere in $\text{Int } Q$ that represents a generator δ of $\pi_2(Q)$ to make Q as well as the entire cobordism 2-connected. Here we use that $n+3 \geq 5$ to ensure that the attaching map can be embedded. Note that the handles are added to the interior, so the boundary has not changed.

- (c) After adding h_2 and h_3 , the resulting space is a CAT cobordism rel ∂ from $0 \times P_0 \times D^n$ to an $(n+3)$ -manifold that we denote $(P_0 \times D^n)^\#$. A sketch of this construction is given in Figure 26.1.

CLAIM. $(P_0 \times D^n)^\#$ is contractible.

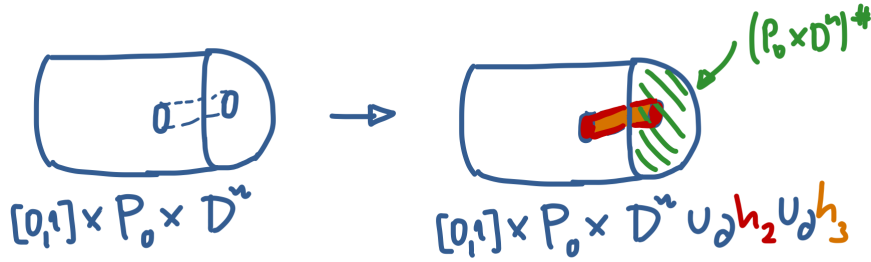

FIGURE 26.1. A visually inaccurate sketch of the construction of $(P_0 \times D^n)^\#$.

Proof. We already know that $(P_0 \times D^n)^\#$ is 2-connected. Using

$$H_*(Q) = H_*(D^{3+n} \# (S^2 \times S^{n+1}))$$

we will apply Hurewicz’s Theorem to see that all homotopy groups vanish, which implies that $(P_0 \times D^n)^\#$ is contractible by Whitehead’s Theorem.

For most of the homology groups, the vanishing is obvious. Only possible nontrivial degrees could be 3 and $n + 1$.

- To Q , we glue a 3-handle, i.e. a $D^3 \times D^{n+1}$ along the S^2 -factor of the 2-handle (this is because the 2-handle generates the nontrivial homotopy group, as observed above). Doing so, no nontrivial third homology can be created.
- For degree $n + 1$, we can use Poincare duality and universal coefficient theorem to see that $H_{n+1}((P_0 \times D^n)^\#) \cong H^3((P_0 \times D^n)^\#) \cong \text{Hom}(H_3((P_0 \times D^n)^\#), \mathbb{Z}) = 0$.

As a result, $\pi_i(P_0 \times D^n) = 0$ for all $i \leq 1$ and therefore $(P_0 \times D^n)^\# \simeq \{\text{pt}\}$. \square

By an analogous argument, we can see that the CAT cobordism $([0, 1] \times P_0 \times D^n) \cup h_2 \cup h_3$ is also contractible.

- (4) Identifying $D^n = [1/4, 3/4]^n$ and considering it as a subset of T^n by $[1/4, 3/4]^n \subset [0, 1]^n / \sim = T^n$, we can include

$$(26.4) \quad ([0, 1] \times P_0 \times D^n) \cup h_2 \cup h_3 \hookrightarrow ([0, 1] \times P_0 \times T^n) \cup h_2 \cup h_3 =: X^{n+4}$$

The attaching maps of the handles shall be the same as before. Again, X^{n+4} is a cobordism relative boundary from $0 \times P_0 \times T^n$ to

$$(P_0 \times T^n)^\# := (P_0 \times D^n)^\# \cup_{\partial} (P_0 \times (T^n \setminus \text{Int } D^n))$$

which gives us the $(n + 3)$ -manifold M that we claim fulfills the desired properties in Theorem 26.2. In other words, we define $M^{n+3} := (P_0 \times T^n)^\#$. Figure 26.2 illustrates the inclusion (26.4).

CLAIM. M is homotopy equivalent to $D^3 \times T^n$ rel ∂ .

Proof. The boundaries of M and $D^3 \times T^n$ are homeomorphic because adding the handles has not changed the boundary. It is therefore immediate that the diagram in Remark 26.3 commutes.

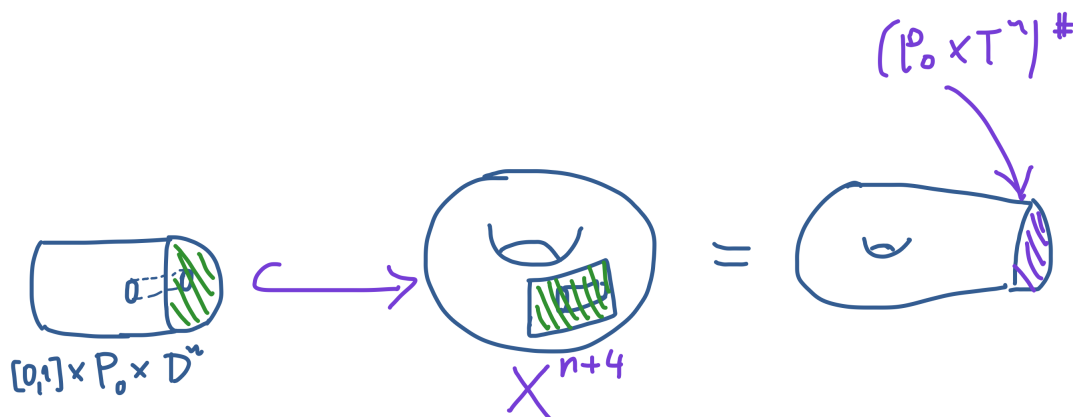

FIGURE 26.2. A visually even more inaccurate sketch of the construction of $M = (P_0 \times T^n)^\#$.

For the homotopy equivalence, consider the pushouts

$$\begin{array}{ccccc}
 P_0 \times D^n & \hookrightarrow & (P_0 \times D^n)^\# & \xrightarrow{\simeq} & D^3 \times D^n \\
 \downarrow i_1 & & \downarrow i_2 & & \downarrow i_3 \\
 P_0 \times T^n & \hookrightarrow & (P_0 \times T^n)^\# & \xrightarrow{f} & D^3 \times T^n
 \end{array}$$

The top right homotopy equivalence can be defined as the composition $(P_0 \times D^n)^\# \rightarrow \text{pt} \rightarrow D^3 \times D^n$. The inclusions i_2 and i_3 are cellular, and hence a cofibration. Therefore f is a homotopy equivalence. \square

26.2.2. Invariance under coverings. Now we want to verify that $[M'] = [M]$ in the pullback in Remark 26.4. In other words, we want to show that M and M' are s -cobordant (which implies that they are isomorphic by the s -cobordism theorem).

Let $c: T^n \rightarrow T^n$ be a CAT covering map of degree d . We can consider the corresponding covering map of $X^{n+4} = [0, 1] \times P_0 \times T^n \cup h_2 \cup h_3$, where the handles are glued onto $1 \times P_0 \times T^n$. That means, the total space \tilde{X}^{4+n} is a copy of $[0, 1] \times P_0 \times T^n$ with d 2-handles and d 3-handles attached, all to $1 \times P_0 \times T^n$. Figure 26.3 provides a sketch of the construction of this total space.

Let us glue X to \tilde{X} along their 0-ends (i.e. $0 \times P_0 \times T^n$) with the identity map to obtain Y^{n+4} . This is a CAT cobordism rel ∂ from M to M' . Moreover, Y is an h -cobordism as the union of two h -cobordisms. By applying Seifert-van Kampen's theorem on X and \tilde{X} at neighbourhoods of h_2 and copies of h_2 , respectively, we see that $\pi_1(Y)$ is free abelian. Therefore $\tau(Y) = 0$. As a result, Y is an s -cobordism and $M \cong M'$ as desired.

26.2.3. Interlude: Milnor's E_8 plumbing. We mention some concepts that will be key to obtaining contradictions in the next subsection.

Definition 26.5. [Bro69, Chapter V] Let ζ_i^n be a rank n vector bundle over an n -dimensional smooth manifold M_i for $i = 1, 2$. Let E_i be the total space of the associated disk bundle and suppose ζ_i, M_i and E_i are oriented in a compatible way. If we pick $x_1 \in M_1$ and $x_2 \in M_2$, and consider a ball neighbourhood of x_i in M_i , the preimage of these will be $D_i^n \times D_i^n$, neighbourhoods of the fiber over x_i . Let $h: D_1^n \rightarrow D_2^n$ and $k: D_2^n \rightarrow D_1^n$ be two diffeomorphisms, either both

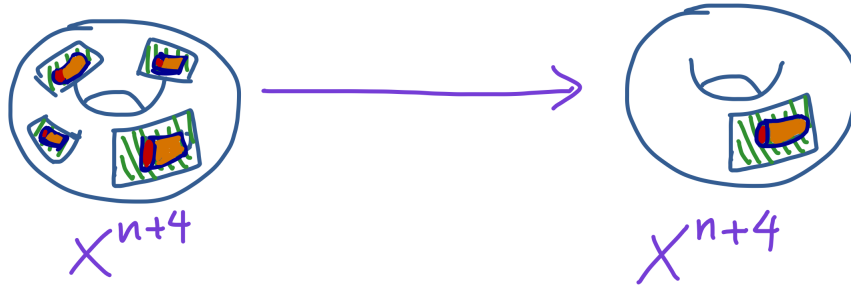
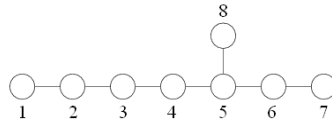

FIGURE 26.3. The torus-component of the covering space.

orientation preserving or both orientation reversing. Then we can define the *plumbing* of the spaces E_1 and E_2 to be the quotient space $P = E_1 \cup_{(k,h)} E_2$.

Remark 26.6. One can inductively plumb more than two total spaces, as well as two different points in one space. In the first case, one can use graphs (in particular, trees) to determine the pairs of spaces that will be plumbed.

Definition 26.7. The Dynkin diagram E_8 looks like this:



Consider the disc bundle over S^2 with Euler number 2. We can plumb 8 copies of this bundle according to the Dynkin diagram given above to obtain *Milnor's E_8 plumbing*, which we denote by P_{E_8} . As a smooth 4-manifold, this can also be considered as a PL manifold.

Remark 26.8. The intersection form on P_{E_8} is given by the matrix

$$\begin{bmatrix} 2 & 1 & 0 & 0 & 0 & 0 & 0 & 0 \\ 1 & 2 & 1 & 0 & 0 & 0 & 0 & 0 \\ 0 & 1 & 2 & 1 & 0 & 0 & 0 & 0 \\ 0 & 0 & 1 & 2 & 1 & 0 & 0 & 0 \\ 0 & 0 & 0 & 1 & 2 & 0 & 0 & 1 \\ 0 & 0 & 0 & 0 & 1 & 2 & 1 & 0 \\ 0 & 0 & 0 & 0 & 0 & 1 & 2 & 0 \\ 0 & 0 & 0 & 0 & 1 & 0 & 0 & 2 \end{bmatrix}$$

Rows and columns are identified with the enumeration in the figure.

This matrix is positive definite, therefore the signature $\sigma(P_{E_8})$ of P_{E_8} is 8. Moreover, it is unimodular. It is well-known that the map $H_2(P_{E_8}) \rightarrow H_2(P_{E_8}, \partial P_{E_8})$ from the long exact homology sequence can be identified with this intersection form because $H_1(P_{E_8})$ is torsion-free. As a result, $H_2(\partial P_{E_8}) = 0 = H_2(\partial P_{E_8})$. The boundary ∂P_{E_8} is connected and oriented, therefore it is a homology sphere. In fact, it is CAT isomorphic to the Poincaré homology sphere P^3 .

26.2.4. Proof of nontriviality. Finally we show that $[M] \neq [D^3 \times T^n] \in \mathcal{S}(D^3 \times T^n \text{ rel } \partial)$, where the right hand side is represented by the canonical CAT structure on $D^3 \times T^n$. In other words, we want to prove that $M \not\cong D^3 \times T^n \text{ rel } \partial$.

For the sake of contradiction, we assume that $M \cong D^3 \times T^n \text{ rel } \partial$. Then we could glue M to $D^3 \times T^n$ along their common boundary to obtain $M_2 := M \cup_{S^2 \times T^n} D^3 \times T^n \cong S^3 \times T^n$.

Next, we consider $P_{E_8} \times T^n$. Its boundary is $\partial P_{E_8} \times T^n \cong P \times T^n$. To $P \times \{\text{pt}\} \subset \partial(P_{E_8} \times T^n)$ we can attach handles as in the construction in Section 26.2.1. This way, we obtain a new space $P_{E_8} \times T^n \cup_{\partial} h_2 \cup_{\partial} h_3 =: V$.

CLAIM. $\partial V \cong_{\text{CAT}} M_2$.

Proof. First, recall that $P_0 = P \# D^3$ which is CAT homeomorphic to P minus a 3-ball. This implies $P = P_0 \cup_{S^2} D^3$ and hence $\partial(P_{E_8} \times T^n) \cong P \times T^n \cong (P_0 \cup_{S^2} D^3) \times T^n \cong P_0 \times T^n \cup_{S^2 \times T^n} D^3 \times T^n$. The gluing of handles is identical as in the construction of M . Moreover, we may assume that the handles are attached to $P_0 \times T^n$, so if we consider ∂V as a cobordism relative boundary, this is equal $M \cup_{S^2 \times T^n} D^3 \times T^n$ by definition of M . \square

Assuming $M_2 \cong S^3 \times T^n$ and using the CAT homeomorphism in the above claim as the attaching map, we can glue a $D^4 \times T^n$, which yields a closed CAT manifold W . To express the homotopy type of W , we introduce $E := P_{E_8} / \partial P_{E_8}$.

CLAIM. $W \simeq E \times T^n$.

Proof. $P_{E_8} \times T^n$ can include in both $W = V \cup_{M_2} D^4 \times T^n$ and $E \times T^n$. The remainder (i.e. the space that is glued to $Q \times T^n$ to yield the respective space) in W is $h_2 \cup h_3 \cup D^4 \times T^n$. Consider the map $f: W \rightarrow E \times T^n$ constructed as follows: We identify $\text{Int } P_{E_8} \times T^n$ with $(E \setminus \{\text{pt}\}) \times T^n$ by the inclusions of $\text{Int } P_{E_8} \times T^n$ into both spaces as described above. The handles h_2 and h_3 are contracted to a point in $S^3 \times T^n \subseteq D^4 \times T^n$, which is then collapsed to $\{\text{pt}\} \times T^n \subset E \times T^n$ by the contraction of the D^4 component. One can show that f induces isomorphisms under H_k for all k using the Mayer-Vietoris exact sequence.

If W and $E \times T^n$ were simply connected, Hurewicz's Theorem would directly imply that f is a homotopy equivalence; however, this is evidently not the case. Therefore we consider the lift $\tilde{f}: \tilde{W} \rightarrow \tilde{E} \times T^n$ of f along universal coverings of both spaces. The identifications of $P_{E_8} \times T^n$ are again identifications when lifted, and the collapses mentioned above also lift to nullhomologous maps. Using Mayer-Vietoris exact sequence, we can see that $H_k(f)$ is an isomorphism for all $k \geq 2$. This implies $\pi_k(\tilde{W}) \cong \pi_k(\tilde{E} \times T^n) \cong \pi_k(W) \cong H_k(E \times T^n)$ for $k \geq 2$ by Hurewicz's Theorem. Therefore, f is a homotopy equivalence. \square

THEOREM 26.9 (Farrell). [Far67] *Let $f: M^m \rightarrow S^1$ be a map of compact CAT manifolds such that $f|_{\partial M}$ is a CAT locally trivial fibration. Then f is homotopic rel $f|_{\partial M}$ to a CAT locally trivial fibration if the following hold:*

- (1) $\dim M \geq 6$.
- (2) The covering \tilde{M} from the pullback

$$\begin{array}{ccc}
 \tilde{M} & \xrightarrow{\tilde{f}} & \mathbb{R} \\
 \bar{p} \downarrow & & \downarrow p \\
 M & \xrightarrow{f} & S^1
 \end{array}$$

where $p: \mathbb{R} \rightarrow S^1$ denotes the standard universal covering, has finite homotopy type.

- (3) $\pi_1(M)$ is free abelian.

Note that condition (2) is assured if $M \simeq X \times S^1$ for X homotopy equivalent to a finite CW-complex. Using the proof of Claim 26.2.4 as well as the observation above, we observe that conditions (2) and (3) are satisfied for $W^{4+n} \xrightarrow{\cong} E_8 \times T^n \xrightarrow{\text{proj}} S^1$ so that we can use Farrell's

Theorem to promote this map to a CAT locally trivial fibration. Then we take a fiber W^{n+3} , which should factor through $E \times T^{n-1}$, again homotopy equivalent to W^{n+3} . Iterating this process, we can create a chain of closed subsets

$$(26.5) \quad W^{4+n} \supseteq W^{3+n} \supseteq \dots \supseteq W^5 \simeq E^4 \times S^1.$$

Finally we need a 4-manifold X^4 to finish our claim, but cannot use Farrell's Theorem anymore, so we just make the map $W^5 \xrightarrow{\simeq} E \times S^1 \xrightarrow{\text{proj}} S^1$ transverse to 0 to obtain an orientable manifold $W^4 \subset W^5$ which we assert contradicts the following theorem due to Rochlin.

THEOREM 26.10 (Rochlin). *Every closed, oriented, smooth or PL 4-manifold W^4 with second Stiefel-Whitney class $w_2(W)$ zero has signature $\sigma(M) \in \mathbb{Z}$ divisible by 16.*

Next week's talk will be about the proof of this theorem. We are rather interested in deriving the following, which will lead to a contradiction:

CLAIM.

- (1) $w_2(W^4) = 0$.
- (2) $\sigma(W^4) = 8$.

Proof. (1) Recall that parallelisable manifolds have trivial Stiefel-Whitney classes. P_{E_8} is parallelisable by construction and hence so is $P_{E_8} \times T^n$. In particular, $w_2(P_{E_8} \times T^n) = 0$. The map $j^*: H^2(W^{n+4}, \mathbb{Z}/2) \rightarrow H^2(P_{E_8} \times T^n, \mathbb{Z}/2)$ is injective, since the map

$$j_*: H_2(P_{E_8} \times T^n, \mathbb{Z}/2) \rightarrow H_2(W^{n+4}, \mathbb{Z}/2)$$

induced by $j: P_{E_8} \hookrightarrow W^{n+4}$ is surjective. Therefore the preimage of $w_2(Q \times T^n)$ is also 0. This is precisely $w_2(W^{n+4})$ by the naturality of Stiefel-Whitney classes.

Inductively, we can argue that each W^k has $w_2(W^k) = 0$ as follows: Consider the map $i^*: H^2(W^{n+1}, \mathbb{Z}/2\mathbb{Z}) \rightarrow H^2(W^n, \mathbb{Z}/2)$ induced by inclusion $i: W^n \hookrightarrow W^{n+1}$. Since W^n is bicollared in W^{n+1} ,

$$\begin{aligned} & \text{TW}^n \oplus \varepsilon \cong \text{TW}^{n+1}|_{W^n} \\ \Rightarrow & w_2(\text{TW}^n \oplus \varepsilon) \cong i^*(w_2(\text{TW}^{n+1})) \\ \Rightarrow & w_2(\text{TW}^n) \cong i^*(w_2(\text{TW}^{n+1})) \end{aligned}$$

As a result, $w_2(\text{TW}^{n+1}) = 0$ implies $i^*(w_2(\text{TW}^{n+1})) = w_2(\text{TW}^n) = 0$, which yields the induction step. After finitely many steps, we reach $w_2(W^4) = 0$.

(2) Recall some properties of σ :

- (a) Signature is cobordism invariant,
- (b) $\sigma(\mathbb{C}P^2) = 1$ and therefore $\sigma(X \times \mathbb{C}P^2) = \sigma(X)$.

So first, $\sigma(W^4) = \sigma(W^4 \times \mathbb{C}P^2)$. The latter space is cobordant to a space $V^8 \simeq \mathbb{C}P^2 \times P_*$. We obtain V^8 by applying Farrell's Theorem to the map $\mathbb{C}P^2 \times W^5 \xrightarrow{\simeq} \mathbb{C}P^2 \times P_* \times S^1 \rightarrow S^1$. The cobordism lies e.g. in the infinite cyclic covering of $\mathbb{C}P^2 \times W^5$. Therefore

$$\sigma(W^4) = \sigma(W^4 \times \mathbb{C}P^2) = \sigma(V^8) = \sigma(\mathbb{C}P^2 \times E) = \sigma(E) = 8$$

The last equality follows because the intersection pairing of P_* is the matrix E_8 . In fact P_* is an important example of why we use manifolds and not homology manifolds in Rochlin's Theorem. □

The above claims imply that our assumption $M \cong D^3 \times T^n \text{ rel } \partial$ cannot hold. We have found a representative for a nontrivial element in $\mathcal{S}(D^3 \times T^n \text{ rel } \partial)$!

26.2.5. Applications with the nontrivial element. After having found an exotic homotopy $D^3 \times T^n$ that we have called M^{3+n} , we want to proceed to produce further exotic spaces.

THEOREM 26.11 (Exotic homotopy $S^3 \times T^n$). *If we glue $D^3 \times T^n$ to M along the common boundary, we obtain a CAT manifold homotopy equivalent to $S^3 \times T^n$ but not CAT isomorphic to $S^3 \times T^n$.*

Proof. The first assertion is clear with the canonical homotopy equivalence between the assembled homotopy equivalent parts, i.e. $M \cup_{\partial} D^3 \times T^n \simeq D^3 \times \cup_{\partial} D^3 \times T^n$. The fact that $M \cup_{\partial} D^3 \times T^n \not\cong S^3 \times T^n$ follows by the above proof, as $M \cup_{\partial} D^3 \times T^n \cong S^3 \times T^n$ was assumed from the second step onwards, which has lead to a contradiction. \square

The following application can be found in [KS77a].

THEOREM 26.12 (Exotic homotopy torus). *Identifying opposite ends of the three interval factors $D^3 \cong [0, 1]^3$, we derive from M a CAT exotic homotopy T^{3+n} .*

Another interesting construction regarding $D^k \times T^n$, $k \leq 3$ is given in [Sie70b, Section 5].

26.2.6. Finding α at last. Recall that we are looking for $\alpha: D^2 \times T^n \rightarrow D^2 \times T^n$ fixing boundary such that

- (1) identifying the opposite endpoints of D^2 to obtain a torus T^2 induces a map $\bar{\alpha}: T^{n+2} \rightarrow T^{n+2}$ that has a mapping torus $T(\bar{\alpha}) := [0, 1] \times T^{n+2} / ((0, x) = (1, \beta(x)))$ not CAT isomorphic to T^{n+3} , and
- (2) for any 2^n -fold standard covering map $p: D^2 \times T^n \rightarrow D^2 \times T^n$, the covering automorphism α' that comes from the lifting

$$\begin{array}{ccc} D^2 \times T^n & \xrightarrow{\alpha'} & D^2 \times T^n \\ p \downarrow & & \downarrow p \\ D^2 \times T^n & \xrightarrow{\alpha} & D^2 \times T^n \end{array}$$

is PL pseudoisotopic to α rel boundary. That is, there exists a PL automorphism H of $([0, 1], \{0, 1\}) \times D^2 \times T^n$ fixing $[0, 1] \times \partial D^2 \times T^n$ such that $H_{0 \times D^2 \times T^n} = 0 \times \alpha$ and $H_{1 \times D^2 \times T^n} = 1 \times \alpha'$.

By Claim 26.2.1, $M = (P_0^3 \times T^n)^\#$ is homotopy equivalent to $D^3 \times T^n$ rel ∂ , in particular, $\partial M \cong S^2 \times T^n$, so M can be seen as an h -cobordism relative boundary from $0 \times D^2 \times T^n$ to $1 \times D^2 \times T^n$. Moreover, the Whitehead torsion $\tau(M)$ vanishes, so that M is an s -cobordism. As $2 + n \geq 5$, the s -cobordism theorem gives rise to a PL homeomorphism $h: [0, 1] \times D^2 \times T^n \xrightarrow{\cong} M$.

Note that by choosing $h|_{0 \times D^2 \times T^n}$ to be the identity by precomposition with $(\text{Id}_{[0,1]} \times h|_{0 \times D^2 \times T^n})$, we induce another automorphism at the other end $1 \times D^2 \times T^n$, which we name $\alpha: D^2 \times T^n \rightarrow D^2 \times T^n$. Indeed, this map cannot have a mapping torus homeomorphic to T^{3+n} , which can be seen by Theorem 26.12.

Finally we need to show the second property. But we have almost established this in Section 26.2.2: We have constructed an s -cobordism Y between M and a covering space M' induced by an arbitrary covering map of T^n . By s -cobordism theorem, this gives us a CAT isomorphism $k: M' \rightarrow M$. Following this construction, the map α' can be created just like α , i.e. if we consider $M' \cong [0, 1] \times D^2 \times T^n$ as an s -cobordism, this yields an isotopy h' from α' to $\text{Id}_{D^2 \times T^n}$. Concatenating h with h' , we obtain a pseudoisotopy from α to α' .

26.3. The catastrophe

The next goal is to construct a PL pseudoisotopy rel ∂ from α to $\text{Id}_{D^2 \times T^n}$. In Thom's terminology, this would be referred to as a catastrophe.

Let $p: D^2 \times T^n \rightarrow D^2 \times T^n$ be derived from scalar multiplication by 2. Define $\alpha_0 := \alpha$ and $H_0 := H$ as in the second property of α . Iteratively, pick α_i to be the lift of α_{i-1} and H_i to be the pseudoisotopy rel ∂ from α_i to α_{i+1} . Here it is worth noting that, as $[M] = [M']$, the covers are always exotic and the maps α_i with mapping tori not PL homeomorphic to the standard T^{3+n} , by induction.

Next, define a PL automorphism H' of $[0, 1] \times D^2 \times T^n$ as follows: for $a_k := 1 - \frac{1}{2^k}$, consider the oriented linear bijection $l_k: [a_k, a_{k+1}] \rightarrow [0, 1]$. Let $H'(x, d, t) = H_k(l_k(x), d, t)$ for $x \in [a_k, a_{k+1}]$. As the H_k fix boundaries, this map is well defined for $x = a_k$ for some k .

Extend H' to $[0, 1] \times \mathbb{R}^2 \times T^n$ by the identity (which is again possible because the boundaries are fixed).

Define $\phi: [0, 1] \times D^2 \times T^n \rightarrow [0, 1] \times D^2 \times T^n$ by $\phi(t, x, y) = (t, (1 - t)x, y)$. Define another continuous bijection of $[0, 1] \times D^2 \times T^n$ by $H'' := \phi H' \phi^{-1}$.

CLAIM. H'' is a well-defined continuous bijection.

Proof. Continuity as well as bijectivity are obvious. We should see that $\phi^{-1}(t, x, y) = (t, \frac{1}{1-t}x, y)$. If $|x| \geq 1 - t$, H' maps $\phi^{-1}(t, x, y)$ to itself by construction, so such points are fixed by H'' . If $x \leq 1 - t$, H' maps the second component to again something in D^2 , and so does ϕ afterwards. This shows that the map is well-defined. \square

The proof also shows that H'' fixes the boundary, setting $x = 1$ and $t = 0$. The following figure from [Sie77] sketches the map H'' on $[0, 1] \times D^2 \times T^n$, each factor shown by one dimension. Note that in the figure, the number of segments that are mapped via α , i.e. the “squares” that are marked with α are doubled for each k . If the figure were dimensionally accurate, they would be multiplied by 2^n instead.

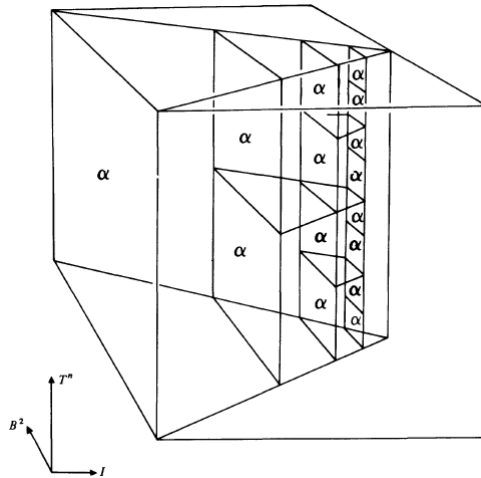

FIGURE 26.4. Schematic description of H'' .

Finally, we extend H'' to a bijection $H'': [0, 1] \times D^2 \times T^n \rightarrow [0, 1] \times D^2 \times T^n$ by $H''|_{1 \times D^2 \times T^n} = \text{Id}_{1 \times D^2 \times T^n}$. It is immediate that bijectivity and well-definedness are preserved. Moreover, the domain is compact and the codomain Hausdorff, so that by the compact-Hausdorff argument, we only need to show that this map is continuous at $1 \times D^2 \times T^n$ in order to prove that it is a TOP homeomorphism.

CLAIM. H'' is continuous at $1 \times D^2 \times T^n$.

Proof. By construction, the part of the D^2 -component of $[0, 1] \times D^2 \times T^n$ that is not fixed by H'' , which is $[a_k, a_{k+1}]$ shrinks strictly for $t \rightarrow 1$. Therefore, at $t = 1$, (t, x, y) is fixed everywhere with $x \neq 0$.

Let $(q_i)_{i \in \mathbb{N}}$ be a sequence of points converging to $q = (1, 0, y)$. Let p_i denote the projection onto the i -th component ($i = 1, 2, 3$). Then $p_i(H''(q_i)) \rightarrow p_i(H''(1, 0, y_*))$, showing the convergence in the first two factors.

To see the convergence in the third factor, let \widetilde{H}_k be the lift

$$\begin{array}{ccc} [0, 1] \times D^2 \times \mathbb{R}^n & \xrightarrow{\widetilde{H}_k} & [0, 1] \times D^3 \times \mathbb{R}^n \\ \downarrow p & & \downarrow p \\ [0, 1] \times D^2 \times T^n & \xrightarrow{H_k} & [0, 1] \times D^2 \times T^n \end{array}$$

of H_k that fixes $[0, 1] \times \partial D^2 \times \mathbb{R}^n$. For $z \in [0, 1] \times D^2 \times \mathbb{R}^n$,

$$(26.6) \quad \sup |p_3(z) - p_3(\widetilde{H}_k(z))| =: d_k$$

is finite. Moreover, \widetilde{H}_k can be expressed as $\theta_k^{-1} \circ \widetilde{H}_0 \circ \theta_k$ with $\theta_k(t, x, y) = (t, x, 2^k y)$ by construction of the H_k . Therefore

$$(26.7) \quad |p_3(z) - p_3(\widetilde{H}_k(z))| = |p_3(z) - p_3(\theta_k^{-1} \circ \widetilde{H}_0 \circ \theta_k)(z)| \leq \frac{1}{2^k} d_0$$

which can be seen by induction: $k = 0$ is obvious and conjugation by $\theta_k = \underbrace{\theta_1 \circ \dots \circ \theta_1}_{k \text{ times}}$ means that the image will be shrunk by a factor of 2. As a result, we see that $d_k \rightarrow 0$ as $k \rightarrow \infty$. Passing to H_k , we see that $\lim p_3(H''(q_i)) = p_3(H_k(q_i)) \xrightarrow{k \rightarrow \infty} p_3(\lim q_i) = p_3(q) = p_3(H''(q))$, as desired. \square

We see that $H''|_{0 \times D^2 \times T^n} = 0 \times \alpha$ and $H''|_{1 \times D^2 \times T^n} = \text{Id}_{D^2 \times T^n}$. In particular, this gives the pseudo-isotopy that we wanted at the beginning of the section. As a result of the s -cobordism theorem, we conclude $M_2 \cong_{\text{TOP}} D^2 \times T^n$. However, this means that the construction of W^{n+4} as in 26.2.4 carries through in the category TOP. In other words, the topological manifold W^{n+4} exists, but its PL-ability is a contradiction to Rochlin's theorem, so it is not PL-able.

26.4. Freedman's work 10 years later

So far, we have been able to construct a manifold that does not admit a PL structure. The key point to non-PL-ability was the contradiction to Rochlin's Theorem, where we used the homotopy type of the E_8 plumbing modulo boundary, which we called E . Instead of this, one might have been tempted to show analogous assertions for E . However, at the time Siebenmann described the above counterexample, it was not known whether P_* is indeed homotopy equivalent to a manifold.

THEOREM 26.13. [Fre82a] *Every homology 3-sphere bounds a fake 4-ball, i.e.a 4-dimensional, compact, contractible manifold.*

Using the theorem above, we can start with Milnor's plumbing $P_{E_8}^4$, which has boundary the Poincare homology sphere P^3 . To P_{E_8} , we shall glue a fake 4-ball that also has P^3 as its boundary, along the boundary with the identity map. This way, we obtain a manifold E' homotopy equivalent to E . In particular, it is homotopy equivalent to a manifold. If this was known in 1970, one could have avoided the construction above by directly showing analogous claims to Claim 26.2.4 with E' , instead of W^4 . In other words, we immediately see that X has no CAT structure by Rochlin's Theorem. On the other hand, the construction we have presented is still considered the easiest, as proving Theorem 26.13 requires more technical work and knowledge.

An immediate consequence of the non-PL-ability of the manifold E' is that Rochlin's Theorem does not hold for the category TOP, as then E' is a spin topological manifold of dimension 4 that has signature 8. Again, it is worth noting that this was not known at the time [KS77a] was published; indeed, it is noted in the aforementioned chapter that Rochlin's Theorem is undecided in the category TOP.

It is also worth noting that E' is also non-triangulable even without requiring the triangulation to be a PL triangulation, as shown in [Fre82a].

Part VIII

Fundamental tools in topological manifolds

Handle decompositions and transversality

Danica Kosanović and Arunima Ray

A topological manifold is covered by charts, each of which is homeomorphic to \mathbb{R}^n or \mathbb{R}_+^n . These admit CAT structures, so locally we can apply results about CAT structures, such as the existence of handle structures or transversality. The product structure theorem will enable us to piece together the local solutions into global solutions. This is based on [KS77b, Essay III].

27.1. Handle decompositions

Definition 27.1. Let W^m be a CAT manifold, with CAT one of TOP, DIFF, PL, and $M \subseteq W$ a codimension zero closed submanifold. A CAT handle decomposition of W relative to M is a filtration

$$M = M_0 \subseteq M_1 \subseteq \dots$$

such that

- $\bigcup_{i \geq 0} M_i = W$,
- for each $i \geq 0$, M_i is a closed codimension zero submanifold of W ,
- for each $i \geq 0$, the set $H_i := \overline{M_i} \setminus \overline{M_{i-1}}$ is a compact submanifold such that

$$(H_i, H_i \cap M_{i-1}) \cong_{\text{CAT}} (D^k, \partial D^k) \times D^{m-k}$$

for some $0 \leq k \leq m$,

- the collection $\{H_i\}$ is locally finite.

For CAT = DIFF we also smooth corners. There is essentially unique smooth structure on the result of attaching a handle. The following is obtained from Morse theory and the flow of a gradient-like vector field (for a proof see Milnor or Thom?).

THEOREM 27.2. *(Relative) handle decompositions exist for smooth manifolds for all m .*

The following result uses barycentric subdivisions instead, see [Hud69, p. 223].

THEOREM 27.3. *(Relative) handle decompositions exist for PL for all m .*

We will prove the PL analogue as a consequence of the product structure theorem and Theorem 27.2.

THEOREM 27.4. *(Relative) handle decompositions exist for TOP for $m \geq 6$.*

For $m \leq 3$ by Rado and Moise all structures are equivalent. Handle decompositions exist for $m = 5$ by the work of Quinn [Qui82a], [FQ90, Chapter 9]. However, for $m = 4$ a handle decomposition exists on W^4 if and only if W^4 is smoothable (equivalently, PL-able). Since there are non-smoothable 4-manifolds, this implies that handle decomposition do not exist for all 4-manifolds.

Sketch of proof of Theorem 27.4. The idea is to apply Product Structure theorem locally, working in charts. Assume for simplicity that $\partial W = \emptyset$ and that W is compact.

Let us cover W by compact sets A_1, \dots, A_k with $A_i \subseteq U_i \cong \mathbb{R}^m$. By pulling back a smooth structure on \mathbb{R}^m , each U_i has a smooth structure, and therefore has a handle decomposition relative to any smooth codimension zero submanifold, by Theorem 27.2.

We will construct a filtration $M = N_0 \subseteq N_1 \subseteq \dots \subseteq N_k = W$ such that each N_i is a TOP handlebody relative to N_{i-1} . This gives a handlebody decomposition of W , by taking the union of respective handlebody filtrations for all N_i .

Assume we have inductively constructed a codimension zero submanifold N_{i-1} for some $i \geq 1$, with $M \cup A_1 \cup A_2 \cdots \cup A_{i-1} \subseteq N_{i-1}$. Let us define

$$P_i := U_i \cap \partial N_{i-1} \subseteq U_i,$$

see Fig. 27.1. This is a codimension one submanifold of W with $\dim \geq 5$, so it has a bicollar $P_i \times \mathbb{R}$ with induced smooth structure from U_i . We have seen Product Structure Theorem 25.4,

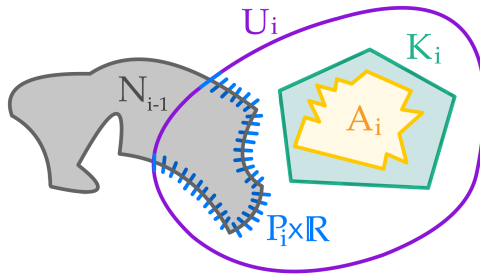

FIGURE 27.1. The induction step in the proof of Theorem 27.4.

but there is also the following local version: one can isotope the smooth structure on U_i relative to $(P_i \times \mathbb{R}) \setminus (P_i \times (-1, 1))$ to a new structure which is a product near $P_i \times \{0\}$. This makes $P_i = P_i \times \{0\}$ into a smooth submanifold of U_i . Thus with this new smooth structure, $U_i \cap N_{i-1}$ is a codimension zero smooth manifold in this new smooth structure from U_i .

Now choose a compact submanifold K_i with $A_i \subseteq K_i \subseteq U_i$. We apply Theorem 27.2 to obtain a handle decomposition for $(U_i \cap N_{i-1}) \cup K_i$ relative to $U_i \cap N_{i-1}$. Then define $N_i := N_{i-1} \cup K_i$. This completes the inductive step. \square

A useful exercise is to consider why the previous proof does not produce a smooth structure on M . The idea is that while the smooth structure is improved on U_i in a neighbourhood of P_i , this does not respect a given smooth structure on N_{i-1} .

27.2. Transversality

There are two main versions of transversality. Map transversality perturbs a map between manifolds by a homotopy so that the inverse image of a point, or indeed a submanifold N , is again a submanifold, and the codimension of the inverse image in the domain equals the codimension of N in the codomain.

There is also submanifold transversality, which is stronger. Given two submanifolds, it enables us to perturb one of them by a locally flat *isotopy*, fixing the other submanifold, until the intersections are transverse.

There is a subtlety that one needs normal microbundles to do both of these carefully. We will not go into this here, and instead present the following warm up version of transversality, which is all we have time for right now.

THEOREM 27.5. *Let $f_0: M^m \rightarrow \mathbb{R}^n$ be a continuous map with M closed topological manifold and $m - n > 4$. Then f_0 is homotopic to f_1 which is transverse to $0 \in \mathbb{R}^n$, that is, $f_1^{-1}(0)$ is a topological manifold L of dimension $m - n$ and has a trivial normal bundle.*

Proof sketch. Cover M by compact sets A_i with $A_i \subseteq U_i \cong \mathbb{R}^m$. Assume for the inductive hypothesis that $f: M \rightarrow \mathbb{R}^n$ is transverse to $0 \in \mathbb{R}^n$ on a neighbourhood Y of $A_1 \cup \dots \cup A_{i-1}$. That is, $(f|_Y)^{-1}(0)$ is an $(m - n)$ -dimensional submanifold $L_{i-1} \subseteq Y$ with trivial normal bundle.

Then $L_{i-1} \cap U_i =: L'$ has trivial normal bundle $L' \times \mathbb{R}^n$. By the Local Product Structure Theorem we can isotope the smooth structure on U_i such that L' is a smooth submanifold. Assume that $L' \times \mathbb{R}^n$ is a smooth normal bundle of L' .

Now apply smooth transversality to $f|_{U_i}$: we can homotope f to $f': M \rightarrow \mathbb{R}^n$ which is transverse to $0 \in \mathbb{R}^n$ on a neighbourhood of A_i , and such that $f' = f$ near $(L_{i-1} \cap \cup_{j=1}^{i-1} A_j) \times \mathbb{R}^n$ and near $M \setminus U_i$. □

Here are some further consequences of the Product Structure Theorem.

- There exist TOP Morse functions.
- Simple homotopy type is well-defined. To do this we find a PL disc bundle over M embedded as a PL submanifold of a high dimensional Euclidean space. The simple homotopy type of this disc bundle turns out to be well-defined, and it gives the simple homotopy type of the manifold M .
- High-dimensional manifolds are homeomorphic to CW complexes (open for 4-manifolds). This follows from the existence of topological handle decompositions.

THEOREM 27.6 (Topological high-dimensional Poincaré conjecture). *If M^m is a compact topological manifold of dimension $m \geq 5$ and $M^m \simeq S^m$, then M^m is homeomorphic to S^m .*

Sketch of proof using the work of Kirby and Siebenmann. For $m = 5$ smoothing theory applies to smooth M^m , and then we can deduce the result using the smooth resolution of the Poincaré conjecture in this dimension.

Assume now $m \geq 6$. Take out two m -balls from M and prove by some elementary algebraic topology computations that what remains is a simply-connected h -cobordism. Then the result follows from the topological h -cobordism theorem and the Alexander trick.

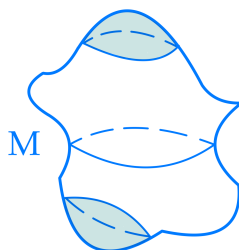

FIGURE 27.2. Reduction of the Poincaré conjecture to the h -cobordism theorem

To show the topological h -cobordism theorem one uses topological handle decomposition and arrange handles are in increasing order. Then cancel or trade any additional handles of index 0, 1, m and $m - 1$. This for example uses perturbing (i.e. transversality) a null-homotopy of the circle that a 1-handle generates, to produce an embedded disc, then thickening this to a cancelling pair of a 2 and a 3-handle.

Then cancel r - and $(r + 1)$ -handle pairs, using Whitney trick. This again requires perturbing the pair into a general position. Once all handles have been cancelled, we must have a product, which completes the outline of the proof of the topological h -cobordism theorem. □

Part IX

Surgery theory

The surgery exact sequence

Mark Powell

Let $n \geq 4$ and fix a category

$$\text{CAT} \in \{\text{TOP}, \text{PL}, \text{DIFF}\}.$$

If $n = 4$ then let $\text{CAT} = \text{TOP}$. For X an n -dimensional Poincaré complex, with $\pi_1(X)$ good in the case that $n = 4$, we will explain the terms and the maps in the (simple) CAT surgery exact sequence

$$\mathcal{N}_{\text{CAT}}(X \times I, X \times \{0, 1\}) \xrightarrow{\sigma} L_{n+1}^s(\mathbb{Z}[\pi_1(X)]) \rightarrow \mathcal{S}_{\text{CAT}}^s(X) \xrightarrow{\rho} \mathcal{N}_{\text{CAT}}(X) \xrightarrow{\sigma} L_n^s(\mathbb{Z}[\pi_1(X)])$$

of pointed-or-empty sets in more detail. Note that the L -groups are category independent, while the other terms depend on the choice of CAT. This is not intended as a substitute for a textbook on surgery theory, but rather the aim will be to explain where the tools we have developed are used to define the maps and establish exactness of the sequence. In particular we will use topological transversality and immersion theory in multiple places. A special case of the surgery sequence, for $X = T^n$, $n \geq 5$ and $\text{CAT} = \text{PL}$, was discussed in detail in Chapter 18.

The exactness of the surgery sequence refers to the following statements for n -dimensional Poincaré complexes X . These statements will be made more precise in this section.

- (i) Let (M, f, ξ, b) be a degree one normal map in $\mathcal{N}_{\text{CAT}}(X)$. Then (M, f, ξ, b) is equivalent (normally bordant) to a degree one normal map (M', f', ξ', b') with f' a simple homotopy equivalence if and only if $\sigma(M, f, \xi, b) = 0 \in L_n^s(\mathbb{Z}[\pi_1(X)])$. In particular, there exists (M, f, ξ, b) with $\sigma(M, f, \xi, b) = 0$ if and only if $\mathcal{S}_{\text{CAT}}^s(X) \neq \emptyset$. We say that the sequence is exact at $\mathcal{N}_{\text{CAT}}(X)$ as a sequence of pointed-or-empty sets.
- (ii) The arrow $L_{n+1}^s(\mathbb{Z}[\pi_1(X)]) \rightarrow \mathcal{S}_{\text{CAT}}^s(X)$ indicates an action of the group on the set, rather than a function. In particular note that this means the surgery sequence makes sense even if $\mathcal{S}_{\text{CAT}}^s(X) = \emptyset$. Wall realisation determines an action of the group $L_{n+1}^s(\mathbb{Z}[\pi_1(X)])$ on $\mathcal{S}_{\text{CAT}}^s(X)$, the orbits of which coincide with the point preimages

$$\{\rho^{-1}([(M, f, \xi, b)]) \mid [(M, f, \xi, b)] \in \mathcal{N}_{\text{CAT}}(X)\}.$$

We say that the surgery sequence is exact at the structure set $\mathcal{S}_{\text{CAT}}^s(X)$.

- (iii) If $\mathcal{S}_{\text{CAT}}^s(X)$ is nonempty then the relative normal maps $\mathcal{N}_{\text{CAT}}(X \times I, X \times \{0, 1\})$ form an abelian group under stacking, and with respect to this group structure the map $\sigma: \mathcal{N}_{\text{CAT}}(X \times I, X \times \{0, 1\}) \rightarrow L_{n+1}^s(\mathbb{Z}[\pi_1(X)])$ is a homomorphism. The stabiliser of each point of $\mathcal{S}_{\text{CAT}}^s(X)$ under the Wall realisation action of $L_{n+1}^s(\mathbb{Z}[\pi_1(X)])$ on $\mathcal{S}_{\text{CAT}}^s(X)$ is precisely the image of σ . We say that the surgery sequence is exact at $L_{n+1}^s(\mathbb{Z}[\pi_1(X)])$.

The reader who wants to learn more can consult for example [Wal99], [Ran02], or [LÖ2]. A key tool will be the following theorem, which passes from algebraic data to geometric data.

THEOREM 28.1 (Sphere embedding theorem). *Let $n = 2m \geq 4$ be even. If $n = 4$ assume that $\pi_1(M)$ is good and that $\text{CAT} = \text{TOP}$. Otherwise for $n \geq 5$, fix a CAT. Let $f_1, \dots, f_k: S^m \sqcup \dots \sqcup S^m \rightarrow M$ be a CAT immersion of framed spheres with $\lambda(f_i, f_j) = 0$ for $i \neq j$, and $\mu(f_i) = 0$*

for every i . If $n = 4$, then in addition assume that there is a collection of algebraically dual, framed immersed spheres $\{g_i\}$ for the $\{f_i\}$.

Then there is a regular homotopy of the $\{f_i\}$ to a collection $f'_1, \dots, f'_k: S^m \sqcup \dots \sqcup S^m \hookrightarrow M$ of disjointly embedded, framed spheres. Moreover these embedded spheres have geometrically transverse spheres $\{g'_i\}$ with g'_i homotopic to g_i for each i .

This theorem is due to Wall for $n \geq 5$, where the proof is to apply the Whitney trick. For $n \geq 5$ and $\text{CAT} = \text{TOP}$, this uses the topological Whitney trick due to Kirby-Siebenmann. For $n = 4$, it is due to Freedman-Quinn.

28.1. Poincaré complexes and the structure set

In the surgery sequence, X will be an n -dimensional *Poincaré complex*, that is a finite CW complex equipped with an orientation character $w: \pi_1(X) \rightarrow \mathbb{Z}/2$ and a *fundamental class* $[X] \in H_n(X; \mathbb{Z}^w)$ such that cap product with $[X]$ induces a simple chain equivalence

$$- \cap [X]: C^{m-*}(X; \mathbb{Z}[\pi_1(X)]^w) \xrightarrow{\cong} C_*(X; \mathbb{Z}[\pi_1(X)]).$$

Observe that for a closed topological manifold M equipped with a nontrivial orientation character there is a canonical choice of a fundamental class. For an oriented topological manifold, the orientation character is of course trivial, and there are two choices of fundamental class per connected component. When $n = 4$, we will assume that $\pi_1(X)$ is good, and we will point out explicitly where this hypothesis is needed.

Every compact topological n -manifold M embeds in high dimensional Euclidean space (see, for example, [Hat02b, Corollary A.9]). Indeed, it is shown in [KS77b, Essay III, Theorem 5.13] that there exists an embedding with a tubular neighbourhood, which is a finite CW complex homotopy equivalent to M , and moreover this process results in a Poincaré complex. Chapman's theorem [Cha74] states that any two CW structures on a compact topological space are simple homotopy equivalent. Thus a compact topological manifold determines a Poincaré complex, unique up to simple homotopy equivalence. For the rest of this chapter, we will assume every compact topological manifold M comes with a choice of Poincaré complex structure. This includes in particular a fundamental class.

Our aim is to describe the CAT surgery sequence, for CAT equal to TOP, PL, or DIFF. Given a Poincaré complex X , the principal aim of the surgery sequence is to compute the *simple structure set* $\mathcal{S}_{\text{CAT}}^s(X)$, which by definition consists of equivalence classes of pairs (M, f) , where M is a closed topological n -manifold and $f: M \rightarrow X$ is a simple homotopy equivalence, respecting fundamental classes. The word simple is meaningful here since M is equipped with a choice of Poincaré complex structure, which is unique up to simple homotopy equivalence.

The equivalence relation is defined by setting $(M, f) \sim (M', f')$ when there exists a cobordism $F: W \rightarrow X \times [0, 1]$ with boundary $\partial(W, F) = -(M, f) \sqcup (M', f')$ such that F is a simple homotopy equivalence. In this case, we say that (M, f) and (M', f') are *s-cobordant* over X . Since such a cobordism W is in particular an *s-cobordism*, the CAT $(n+1)$ -dimensional *s-cobordism* theorem implies that this equivalence relation is the same as that of CAT isomorphism over X . This means that there is a CAT isomorphism $g: M \rightarrow M'$ with $f: M \rightarrow X$ and $f' \circ g: M \rightarrow X$ homotopic maps.

We argue that the two equivalence relations agree. First, if M and M' are CAT isomorphic over X , with $G: M \times [0, 1] \rightarrow X$ a homotopy between $f' \circ g$ and f , then let $W := M \times [0, 1]$ and identify M' with $M \times \{1\}$ using g . Then define $F: W \rightarrow X \times [0, 1]$ by $(m, t) \mapsto (G(m, t), t)$. This gives an *s-cobordism* between M and M' over $X \times [0, 1]$, as desired. On the other hand, if M and M' are *s-cobordant* over X , then we have a cobordism W with a map $F: W \rightarrow X \times [0, 1]$ and the *s-cobordism* theorem tells us that we have a CAT isomorphism $M \times [0, 1] \rightarrow W$ restricting to the identity of M on $M \times \{0\}$. Restricting to $M \times \{1\}$, this gives a CAT isomorphism $g: M \rightarrow M'$. Composing with the projection $X \times I \rightarrow X$ gives a map $M \times [0, 1] \rightarrow W \rightarrow X \times [0, 1] \rightarrow X$,

which restricts to f on $M \times \{0\}$ and to $f' \circ g$ on $M \times \{1\}$. This is exactly the homotopy we desire.

In the surgery programme for classifying closed (oriented) CAT manifolds up to homeomorphism within a fixed simple homotopy equivalence class, one computes the quotient of $\mathcal{S}_{\text{CAT}}^s(X)$ by simple self-homotopy equivalences of X which respect the fundamental class. This is sufficient since for a fixed closed, CAT n -manifold M , if we have simple homotopy equivalences $f, f': M \rightarrow X$, the map $f^{-1} \circ f': M \rightarrow M$ is a simple self-homotopy equivalence and given any simple self-homotopy equivalence $\phi: M \rightarrow M$ and simple homotopy equivalence $f: M \rightarrow X$, the map $f \circ \phi: M \rightarrow X$ is a simple homotopy equivalence. To obtain the unoriented classification, one then factors out by the choice of fundamental class. See [CM19] for more on the passage from the structure set to the set of manifolds up to homeomorphism.

Note that for a given X , there might not be any CAT n -manifold simple homotopy equivalent to X , in which case $\mathcal{S}_{\text{CAT}}^s(X)$ is empty. If $\mathcal{S}_{\text{CAT}}^s(X)$ is nonempty, then one must fix a choice of CAT manifold M with a simple homotopy equivalence $f: M \rightarrow X$ as the distinguished point in $\mathcal{S}_{\text{CAT}}^s(X)$. If X is itself a CAT manifold, (X, Id) is the distinguished point.

28.2. Normal maps

Define $G(k)$ to be the monoid of self-homotopy equivalences of S^{k-1} . The space $BG(k)$ is the classifying space for fibrations with fibres homotopy equivalent to S^{k-1} and fibre automorphisms given by self-homotopy equivalences. Define BG to be the colimit of $\{BG(k)\}$ over all k . As before, define the space $BCAT(k)$ to be the classifying space for \mathbb{R}^k fibre bundles with structure group the topological group of CAT isomorphisms of \mathbb{R}^k that fix the origin (with the appropriate topology, as discussed in Chapter 21), and define $BCAT$ to be the colimit of $\{BCAT(k)\}$ over all k . There is a forgetful map $BCAT \rightarrow BG$ defined by restricting to $\mathbb{R}^k \setminus \{0\}$ on each $BCAT(k)$. Henceforth we refer to these \mathbb{R}^k fibre bundles as CAT bundles.

A Poincaré complex X comes equipped with a canonical stable spherical fibration classified by (the homotopy class of) a map $X \rightarrow BG$, called the *Spivak normal fibration* [Spi67]. A CAT manifold M comes equipped with a canonical stable CAT bundle classified by a map $M \rightarrow BCAT$, called the *stable normal bundle* of M , denoted by ν_M .

The set of *normal maps* $\mathcal{N}_{\text{CAT}}(X)$ is the set of equivalence classes of quadruples (M, f, ξ, b) where $f: M \rightarrow X$ is a degree one map from a closed, CAT n -manifold M to X mapping the fundamental class $[M]$ to $[X]$, together with a stable CAT bundle $\xi \rightarrow X$ and a bundle map $b: \nu_M \rightarrow \xi$. In other words, we have the following diagram

$$\begin{array}{ccc} \nu_M & \xrightarrow{b} & \xi \\ \downarrow & & \downarrow \\ M & \xrightarrow{f} & X. \end{array}$$

Since normal maps are often the input to the surgery programme, we sometimes refer to a normal map as a *surgery problem*. We remark that it is a consequence of the definitions that ξ lifts the Spivak normal fibration, although this is not obvious.

Two such quadruples (M, f, ξ, b) and (M', f', ξ', b') are said to be equivalent if they are cobordant over X , that is if there exists a quadruple (W, F, Ξ, B) consisting of a cobordism $F: W \rightarrow X \times [0, 1]$ with boundary $\partial(W, F) = -(M, f) \sqcup (M', f')$ such that the fundamental class $[W]$ maps to $[X \times [0, 1]] \in H_{n+1}(X \times [0, 1], X \times \{0, 1\}; \mathbb{Z}^w)$, a stable CAT bundle $\Xi \rightarrow X \times [0, 1]$, and a stable bundle map $B: \nu_W \rightarrow \Xi$ such that the bundle data extend the given bundle data (ξ, b) and (ξ', b') on M and M' respectively.

Remark 28.2. If the Spivak normal fibration of a Poincaré complex X lifts to $X \rightarrow BCAT$ we say it has a CAT bundle reduction. If a Poincaré complex X admits a CAT bundle reduction, then there

exists a degree one normal map (M, f, ξ, b) to X , with respect to the given reduction [Ran02, Theorem 9.42]. This uses transversality (see Section 27.2).

Now we define the map $\mathcal{S}_{\text{CAT}}^s(X) \rightarrow \mathcal{N}_{\text{CAT}}(X)$. Let (M, f) represent an element of $\mathcal{S}_{\text{CAT}}^s(X)$. Choose a homotopy inverse $g: X \rightarrow M$ for $f: M \rightarrow X$, and define $\xi := g^*(\nu_M)$ to be the pullback of the stable CAT normal bundle of M . A stable bundle map $b: \nu_M \rightarrow \xi$ is equivalent to an isomorphism $f^*(\xi) = f^* \circ g^*(\nu_M) = (g \circ f)^* \nu_M \cong \nu_M$, which we obtain from a homotopy $h: g \circ f \sim \text{Id}: M \rightarrow M$. The image of (M, f) in $\mathcal{N}_{\text{CAT}}(X)$ is defined to be (M, f, ξ, b) and the distinguished point of $\mathcal{N}_{\text{CAT}}(X)$ is by definition the image of the chosen distinguished point of $\mathcal{S}_{\text{CAT}}^s(X)$. A different choice of homotopy $h': g \circ f \sim \text{Id}$ determines a different stable bundle map b' . However, since $h, h': M \times [0, 1] \rightarrow M$ are both the identity on one end they are each homotopic to the projection $M \times [0, 1] \rightarrow M$. Stacking these, there is a homotopy $\bar{h}: (M \times [0, 1]) \times [0, 1] \rightarrow M$ from h to h' . This homotopy can be used to construct a degree one normal bordism $(M \times [0, 1], f \times \text{Id}, (g \times \text{Id})^* \nu_{M \times [0, 1]}, B)$ from (M, f, ξ, b) to (M, f, ξ, b') , proving that the normal bordism class of (M, f, ξ, b) does not depend on the choice of h (and thus of b). Moreover, if g' is another choice of homotopy inverse for f , then there is a homotopy $g' = \text{Id} \circ g' \sim g \circ f \circ g' \sim g \circ \text{Id} = g$, which can similarly be used to show that the normal bordism class does not depend on the choice of g , and thus of ξ .

To complete the argument that the map is well defined one must also show that (M, f) and (M', f') , representing equal elements in $\mathcal{S}_{\text{CAT}}^s(X)$, are mapped to the same element in $\mathcal{N}_{\text{CAT}}(X)$.

We also need the relative normal maps $\mathcal{N}_{\text{CAT}}(X \times [0, 1], X \times \{0, 1\})$. An element is represented by a degree one normal bordism between two CAT isomorphisms. That is, a CAT manifold W with boundary $M \sqcup N$, together with a degree one map

$$F: (W; M, N) \rightarrow (X \times [0, 1]; X \times \{0\}, X \times \{1\})$$

such that the restrictions to M and N give CAT isomorphisms $M \rightarrow X \times \{0\}$ and $N \rightarrow X \times \{1\}$, and bundle data (Ξ, B) just as in the definition of a degree one normal bordism. That is, a stable CAT bundle $\Xi \rightarrow X \times [0, 1]$, and a stable CAT bundle map $B: \nu_W \rightarrow \Xi$. We can add two such normal bordisms (W_i, F_i, Ξ_i, B_i) , $i = 1, 2$, together by stacking:

$$X \times [0, 1] \cup X \times [0, 1] \cong X \times [0, 2] \cong X \times [0, 1].$$

Then we glue $W_1 \cup W_2$ using $N \cong X \times \{1\} \cong X \times \{0\} \cong M$. Then the map to $X \times [0, 2]$ extends, and we obtain an addition.

28.3. L -groups

Let $\bar{}$ denote the involution on $\mathbb{Z}[\pi_1(X)]$ generated by sending $g \mapsto w(g)g^{-1}$ for every $g \in \pi_1(X)$, where as before w denotes the orientation character. Fix an integer m . Recall that a form $\lambda: P \times P \rightarrow \mathbb{Z}[\pi_1(X)]$ on a finitely generated, free, based $\mathbb{Z}[\pi_1(X)]$ -module P is said to be

- (1) *sesquilinear* if $\lambda(ra, sb) = r \cdot \lambda(a, b) \cdot \bar{s}$, for all $r, s \in \mathbb{Z}[\pi_1(X)]$ and $a, b \in P$;
- (2) $(-1)^m$ *hermitian* if $\lambda(a, b) = (-1)^m \lambda(\bar{b}, a)$, for all $a, b \in P$;
- (3) *nonsingular* if the adjoint map $\lambda^{ad}: P \rightarrow P^*$ sending $a \mapsto \lambda(a, -)$ is an isomorphism; and
- (4) *simple* if λ^{ad} has vanishing Whitehead torsion with respect to the preferred basis of P .

A *quadratic enhancement* of λ is a function $\mu: P \rightarrow \mathbb{Z}[\pi_1(X)]/g \sim \bar{g}$ so that

- (1) $\mu(r \cdot a) = r\mu(a)\bar{r}$, for all $r \in \mathbb{Z}[\pi_1(X)]$ and $a \in P$;
- (2) $\mu(a) + (-1)^m \mu(\bar{a}) = \lambda(a, a)$, for all $a \in P$; and
- (3) $\mu(a + b) - \mu(a) - \mu(b) = \text{pr}(\lambda(a, b))$ for all $a, b \in P$, where pr is the projection map.

A triple (P, λ, μ) satisfying all the properties above is called a *nonsingular $(-1)^m$ quadratic form*. For Q a finitely generated, free, based $\mathbb{Z}[\pi_1(X)]$ -module, we have a form λ on $Q \oplus Q^*$ given by

$$\begin{pmatrix} 0 & \text{ev} \\ (-1)^m \text{ev} & 0 \end{pmatrix}$$

where ev denotes either evaluation or the canonical identification $Q \cong Q^{**}$ followed by evaluation. In other words, for $(p, f), (q, g) \in Q \oplus Q^*$, define $\lambda((p, f), (q, g)) := f(q) + g(p)$. Use the quadratic enhancement for λ given by setting $\mu(q) = 0 = \mu(q^*)$ for every $q \in Q, q^* \in Q^*$. The nonsingular $(-1)^m$ quadratic form

$$H_{(-1)^m}(Q) := (Q \oplus Q^*, \lambda, \mu)$$

is called the *standard $(-1)^m$ -hyperbolic form* on Q .

The sum of two nonsingular quadratic forms is constructed by taking the direct sum of each element of the triple. Two nonsingular quadratic forms (P, λ, μ) and (P', λ', μ') are said to be isometric if there is an isomorphism $P \xrightarrow{\cong} P'$ inducing isometries of λ and λ' as well as μ and μ' .

28.4. The L groups for n even

Suppose that n is even, and write $n = 2m$. The L -group $L_{2m}^s(\mathbb{Z}[\pi_1(X)])$ is defined to be the set of nonsingular $(-1)^m$ quadratic forms, modulo the equivalence relation generated by declaring two nonsingular quadratic forms (P, λ, μ) and (P', λ', μ') to be equivalent if there are finitely generated, free, based $\mathbb{Z}[\pi_1(X)]$ -modules Q and Q' and an isometry

$$(P, \lambda, \mu) \oplus H(Q) \cong (P', \lambda', \mu') \oplus H(Q')$$

such that the underlying isomorphism of based modules has vanishing Whitehead torsion. In other words, $L_{2m}^s(\mathbb{Z}[\pi_1(X)])$ consists of equivalence classes of sesquilinear, $(-1)^m$ -hermitian, nonsingular simple forms $\lambda: P \times P \rightarrow \mathbb{Z}[\pi_1(X)]$ on a finitely generated, free, based $\mathbb{Z}[\pi_1(X)]$ -module P , together with a quadratic enhancement $\mu: P \rightarrow \mathbb{Z}[\pi_1(X)]/g \sim \bar{g}$. In this group, the inverse of (P, λ, μ) is $(P, -\lambda, -\mu)$ and the zero element is the class of the hyperbolic forms, which is also the distinguished element of $L_{2m}^s(\mathbb{Z}[\pi_1(X)])$ thought of as a pointed set.

A free, half-rank submodule $i_L: L \rightarrow P$ of a nonsingular $(-1)^m$ -quadratic form (P, λ, μ) is known as a *lagrangian* if both λ and μ vanish on L . A lagrangian determines a short exact sequence

$$0 \longrightarrow L \xrightarrow{i_L} P \xrightarrow{(i_L)^* \circ \lambda^{ad}} L^* \longrightarrow 0$$

and a based lagrangian is called *simple* when this sequence has vanishing Whitehead torsion. It is known that a nonsingular $(-1)^m$ quadratic form is isomorphic to a hyperbolic form $H_{(-1)^m}(L)$, such that the underlying isomorphism of based modules has vanishing Whitehead torsion, if and only if the form admits a simple lagrangian [Wal99]*Lemma 5.3. Thus a nonsingular $(-1)^m$ -quadratic form vanishes in $L_{2m}^s(\mathbb{Z}[\pi_1(X)])$ if and only if it admits a simple lagrangian after stabilisation by a hyperbolic form $H_{(-1)^m}(Q)$ for some finitely generated, free, based $\mathbb{Z}[\pi_1(X)]$ -module Q .

28.5. The L groups for n odd

Next, we start to give the background needed to define the *surgery obstruction group* $L_n^s(\mathbb{Z}[\pi_1(X)])$ in the case that n is odd. So write $n = 2m + 1$.

A *nonsingular $(-1)^m$ -quadratic formation* consists of a nonsingular $(-1)^m$ -quadratic form (P, λ, μ) together with two simple lagrangians F and G . That is, based, half-rank finitely generated, free summands of P such that $\lambda(F, F) = \lambda(G, G) = \mu(F) = \mu(G) = 0$, and such that the short exact sequences associated to the lagrangians have vanishing Whitehead torsion.

Addition of nonsingular quadratic formations is by direct sum on each of the entries in the 5-tuple. Two nonsingular $(-1)^m$ -quadratic formations (P, λ, μ, F, G) and $(P', \lambda', \mu', F', G')$ are isomorphic if there exists an isomorphism of modules $\theta: P \xrightarrow{\cong} P'$ inducing both an isometry of nonsingular $(-1)^m$ -quadratic forms and isomorphisms $F \cong F'$ and $G \cong G'$, such that each of these three module isomorphisms has vanishing Whitehead torsion.

Since every nonsingular quadratic form with a simple lagrangian is known to be isomorphic to a hyperbolic form, every nonsingular quadratic formation is isomorphic to $(H(P), P, G)$ for

some finitely generated, free, based $\mathbb{Z}[\pi_1(X)]$ -module P and for some simple lagrangian G of $H(P)$. Here we are using the fact that P is always a simple lagrangian for $H(P)$.

Equivalence of nonsingular $(-1)^m$ -quadratic formations is more difficult to define. We will need the following definitions.

- (1) We say that two nonsingular $(-1)^m$ -quadratic formations, given by (P, λ, μ, F, G) and $(P', \lambda', \mu', F', G')$, are *stably isomorphic* if there are finitely generated, free, based $\mathbb{Z}[\pi_1(X)]$ -modules Q, Q' such that

$$(P, \lambda, \mu, F, G) \oplus (H(Q), Q, Q^*) \cong (P', \lambda', \mu', F', G') \oplus (H(Q'), Q', (Q')^*).$$

- (2) Given a $(-1)^{m+1}$ -hermitian quadratic form (P, λ, μ) , we define the *boundary formation*

$$\partial(P, \lambda, \mu) := (H_{(-1)^m}(P), P, \Gamma_{(P, \lambda)})$$

where $\Gamma_{(P, \lambda)} := \{(p, \lambda^{ad}(p)) \mid p \in P\} \subseteq P \oplus P^*$ is called the *graph lagrangian* of (P, λ) ; it does not depend on μ .

We say that two nonsingular $(-1)^m$ -quadratic formations (P, λ, μ, F, G) and $(P', \lambda', \mu', F', G')$ are equivalent if there exist $(-1)^{m+1}$ -hermitian quadratic forms (Q, λ, μ) and (Q', λ', μ') such that $(P, \lambda, \mu, F, G) \oplus \partial(Q, \lambda, \mu)$ is stably isomorphic to $(P', \lambda', \mu', F', G') \oplus \partial(Q', \lambda', \mu')$.

The L -group $L_{2m+1}^s(\mathbb{Z}[\pi_1(X)])$, also called the *surgery obstruction group*, consists of stable isomorphism classes of nonsingular $(-1)^m$ -quadratic formations, modulo boundary formations. The trivial element in the group is represented by formations $(H_{(-1)^m}(F), F, F^*)$ where F is a finitely generated, free, based $\mathbb{Z}[\pi_1(X)]$ -module.

28.6. Decorations L groups

As indicated by the sub- and superscripts, there are versions of the L -groups with other decorations. Since the definitions only depend on the parity of m , with a fixed superscript the L -groups are 4-periodic in n . For other decorations, the symmetric theory, and negative indices, the interested reader should consult [HT00] for an initial guide, with more details in, for example, [Ran73], [Ran80, Section 9], [Ran81, Section 1.10], and [Ran92].

Related to the simple s decoration, we will need the following definitions.

- (1) Two bases for a given finitely generated, free $\mathbb{Z}[\pi_1(X)]$ -module are called *simply equivalent* if the change of basis matrix has vanishing Whitehead torsion.
- (2) Two bases \mathcal{B}_1 and \mathcal{B}_2 for a given finitely generated, free $\mathbb{Z}[\pi_1(X)]$ -module P are said to be *stably simply equivalent* if \mathcal{B}_1 and \mathcal{B}_2 can be extended to bases \mathcal{B}'_1 and \mathcal{B}'_2 for a stabilisation of P by a free $\mathbb{Z}[\pi_1(X)]$ -module, such that \mathcal{B}'_1 and \mathcal{B}'_2 are simply equivalent.
- (3) A basis for a stabilisation of a finitely generated, free $\mathbb{Z}[\pi_1(X)]$ -module P is called a *stable basis* for P .

28.7. The surgery obstruction map

Consider a quadruple (M, f, ξ, b) representing an element of $\mathcal{N}_{\text{CAT}}(X)$. Since f is degree one, M is connected and $\pi_1(f): \pi_1(M) \rightarrow \pi_1(X)$ is surjective. Perform surgery on classes in $\ker(\pi_1(f))$ to alter (M, f) so that $\pi_1(f)$ is an isomorphism. More precisely, surgery produces a normal bordism, by adding handles along embedded curves representing generators of $\ker(\pi_1(f))$, from (M, f, ξ, b) to some (M', f', ξ', f') where $\pi_1(f')$ is an isomorphism. But, as is customary, we will abuse notation and keep using the same symbols. Continue this process up until the middle dimension, to obtain f'' with $\pi_i(f'') = 0$ for $i < n/2$. This process is called *surgery below the middle dimension*. It uses immersion theory and transversality to represent homotopy classes by framed embedded spheres, in order to perform surgery on them.

28.8. The surgery obstruction map for n even

Let $n = 2m \geq 4$ be even. We now have (M, f, ξ, b) such that f induces an isomorphism on homotopy groups π_i for $i < m$. By Whitehead's theorem and Poincaré duality, since X is n -dimensional, the sole obstruction to f being a homotopy equivalence is the module

$$\ker(\pi_m(f)) \cong K_m(f) := \ker(H_m(f): H_m(M; \mathbb{Z}[\pi_1(X)]) \rightarrow H_m(X; \mathbb{Z}[\pi_1(X)])).$$

The submodule $K_m(f)$ is called the *surgery kernel* of f . Above we used the Hurewicz theorem to pass from homotopy groups to the homology groups of the universal covers. The intersection form of M restricts to an even, nonsingular, sesquilinear, $(-1)^m$ -hermitian form λ on the finitely generated, stably free $\mathbb{Z}[\pi_1(X)]$ -module $K_m(f)$, which is known to have a preferred simple equivalence class of stable basis (see the following paragraph). Perform surgeries on trivial $(m-1)$ -spheres in M to add a hyperbolic form to $K_m(f)$ and whence realise any stabilisation. Again using the same notation after the surgeries, we have that $P := K_m(f)$ is now a finitely generated, free $\mathbb{Z}[\pi_1(X)]$ -module with a preferred simple equivalence class of basis. If the orientation character w is trivial on order two elements of $\pi_1(M)$ and m is even, then since the form λ is even, there is a unique quadratic enhancement μ , which equals the self-intersection number of elements of $K_m(f)$, represented as immersed spheres in their preferred regular homotopy classes. For m odd the quadratic refinement is crucial extra data. In general, the normal data determine a unique regular homotopy class of immersions for each element of $K_m(f)$, which gives rise to a quadratic enhancement $\mu: K_m(f) \rightarrow \mathbb{Z}[\pi_1(X)]/g \sim \bar{g}$. Thus we have obtained an element $\sigma(M, f, \xi, b) = [(K_m(f), \lambda, \mu)] \in L_{2m}^s(\mathbb{Z}[\pi_1(X)]) = L_n^s(\mathbb{Z}[\pi_1(X)])$, which is called the *surgery obstruction* for (M, f, ξ, b) . That is, we have defined the map

$$\sigma: \mathcal{N}_{\text{CAT}}(X) \rightarrow L_n^s(\mathbb{Z}[\pi_1(X)]).$$

So far we have discussed the procedure given in [Wal99]*Chapters 1, 2, and 5. Chapter 1 performs surgery below the middle dimension as above, while Chapter 2 shows that the surgery kernel $K_m(f)$ is finitely generated and stably free with a preferred simple equivalence class of stable basis, and that the intersection form restricts to a form on $K_m(f)$ with a quadratic enhancement. Chapter 5 of [Wal99] constructs the surgery obstruction and shows that it only depends on the normal bordism class of (M, f, ξ, b) , so σ gives a well defined map from $\mathcal{N}_{\text{CAT}}(X)$ to $L_n^s(\mathbb{Z}[\pi_1(X)])$. Briefly, suppose that (M, f, ξ, b) and (M', f', ξ', b') are equivalent in $\mathcal{N}_{\text{CAT}}(X)$ via (W, F, Ξ, B) . Assume we have performed the surgery on trivial embeddings of S^{m-1} in both M and M' to stabilise $K_m(f)$ and $K_m(f')$ to a free modules. Now perform surgeries on the interior of W to make $\pi_i(F)$ an isomorphism for $i < m$. By handle cancellation as in the proof of the s -cobordism theorem, there is now a handle decomposition of W relative to M consisting only of k m -handles and ℓ $(m+1)$ -handles, for some integers k and ℓ . In the topological category, this uses that manifolds of dimension at least five admit topological handle decompositions (see Section 13.3 for dimension at least 6). This is sufficient to determine an isomorphism

$$(K_m(f), \lambda, \mu) \oplus H(\mathbb{Z}[\pi_1(X)]^k) \cong (K_m(f'), \lambda', \mu') \oplus H(\mathbb{Z}[\pi_1(X)]^\ell).$$

To see that there is a simple isomorphism between these forms requires more care, and for this we refer the reader to [Wal99, Theorem 5.6].

28.9. The surgery obstruction map for n odd

Let $n = 2m + 1 \geq 5$ be odd. Again assume that we have a degree one normal map (M, f, ξ, b) such that f induces an isomorphism on homotopy groups π_i for $i < m$. By Whitehead's theorem and Poincaré duality, since X is n -dimensional, the sole obstruction to f being a homotopy equivalence is the surgery kernel:

$$K_m(f) := \ker(H_m(f): H_m(M; \mathbb{Z}[\pi_1(X)]) \rightarrow H_m(X; \mathbb{Z}[\pi_1(X)])).$$

Using this we define a $(-1)^m$ -quadratic formation. By transversality we can represent generators of $K_m(f)$ by framed, embedded m -spheres. Tube these spheres together, to obtain $U \cong \natural^k S^m \times D^{m+1} \subseteq M$, for some k , with the generators of $\pi_m(U)$ generating $P := K_m(f)$. The boundary is the $2m$ -manifold $\partial U := \#^k S^m \times S^m$. The quadratic intersection form of ∂U is a $(-1)^m$ hyperbolic form $H_{(-1)^m}(P)$ on $K_m(\partial U) \cong P \oplus P^*$. Consider the $(-1)^m$ -quadratic formation

$$(H_{(-1)^m}(P), P, \text{Im}(K_{m+1}(M, \partial U) \rightarrow K_m(\partial U))).$$

This determines an element of $L_{2m+1}^s(\mathbb{Z}[\pi_1(X)])$, which turns out to be independent of the choices of generating set for $K_m(f)$ and the choices of embedded, framed spheres representing the generating set. It is the image of (M, f, ξ, b) under the surgery obstruction map $\sigma: \mathcal{N}_{\text{CAT}}(X) \rightarrow L_n^s(\mathbb{Z}[\pi_1(X)])$, in the case that n is odd. One also needs to show that the simple equivalence class of these formations only depends on the normal bordism class.

28.10. Exactness at the normal maps

We now show that the surgery sequence is exact at $\mathcal{N}_{\text{CAT}}(X)$. Consider the image $(M, f, \xi, b) \in \mathcal{N}_{\text{CAT}}(X)$ of an element $(M, f) \in \mathcal{S}_{\text{CAT}}^s(X)$, under the map in the surgery sequence. Since f is a homotopy equivalence, no surgery below the middle dimension is necessary, and the surgery kernel $K_m(f)$ is already trivial. Thus $\sigma(M, f, \xi, b) = 0 \in L_n^s(\mathbb{Z}[\pi_1(X)])$. This shows half of the desired exactness, namely that the image of $\mathcal{S}_{\text{CAT}}^s(X)$ lies in the kernel of $\sigma: \mathcal{N}_{\text{CAT}}(X) \rightarrow L_n^s(\mathbb{Z}[\pi_1(X)])$.

28.11. Exactness at normal maps for n even

Let $n = 2m \geq 4$ be even. Now suppose that (M, f, ξ, b) lies in the kernel of σ . We will show that (M, f, ξ, b) is normally bordant to a simple homotopy equivalence. That is, after a finite sequence of surgeries below the middle dimension, including on trivially embedded copies of S^{m-1} to realise stabilisation, we have that $K_2(f) \cong \ker(\pi_2(f))$ is a free, finitely generated $\mathbb{Z}[\pi_1(X)]$ -module and the intersection form is hyperbolic. Our aim is to perform surgery on m -dimensional homotopy classes representing a lagrangian of this hyperbolic form. This means representing a half basis of $K_m(f)$ by framed, embedded m -spheres, and for each such embedding replacing a neighbourhood $S^m \times D^m$ with $D^{m+1} \times S^{m-1}$. This has the effect of killing the homotopy class represented by the core $S^m \times \{0\}$. If the embedding has a geometrically transverse sphere, then a meridian $\{\text{pt}\} \times S^{m-1}$ to the removed S^m is null-homotopic, via the transverse sphere minus its intersection with $S^m \times D^m$. Thus the surgery operation does not affect $\pi_{m-1}(f)$, which therefore remains an isomorphism.

Thankfully, we are in exactly the situation of the sphere embedding Theorem 28.1. Choose any simple lagrangian P for the quadratic form $(K_m(f), \lambda, \mu)$. There is then an isomorphism from $(K_m(f), \lambda, \mu)$ to the hyperbolic form $H_{(-1)^m}(P)$, such that the isomorphism on modules has vanishing Whitehead torsion. Consider classes $\{f_i\}$ generating P , and classes $\{g_i\}$ generating P^* . Then restricting to the preferred regular homotopy classes determined by the normal data, the set $\{f_i\}$ and $\{g_i\}$ can be represented by framed, immersed spheres $S^m \looparrowright M$, such that $\lambda(f_i, g_j) = \delta_{ij}$, $\lambda(f_i, f_j) = 0$, and $\mu(f_i) = 0$ for all i, j . By hypothesis, if $n = 4$ then $\pi_1(M) \cong \pi_1(X)$ is good.

Then the sphere embedding Theorem 28.1 (due to Wall in high dimensions at least 5 and due to Freedman-Quinn in dimension 4) says that the $\{f_i\}$ are regularly homotopic to a collection of mutually disjoint, embedded spheres $\{f'_i\}$ with geometrically transverse spheres $\{g'_j\}$. The set $\{f'_i\}$ is framed since the set $\{f_i\}$ was. Use $\{f'_i\}$ as the data for surgery to construct a normal bordism from (M, f, ξ, b) to some (M', f', ξ', b') such that $f': M' \rightarrow X$ induces an isomorphism on π_i for $i = 0, 1, 2$. Then, as mentioned earlier, by Poincaré duality and the Hurewicz theorem f' induces an isomorphism on all homotopy groups and is therefore a homotopy equivalence by Whitehead's theorem. Moreover, the homotopy equivalence $f': M' \rightarrow X$ is simple by [Wal99, Theorem 5.6].

28.12. Exactness at normal maps for n odd

Let $n = 2m + 1 \geq 5$ be odd. The procedure is the same as above: do surgeries on generators of $K_m(f)$, after representing them by framed embedded spheres. This latter step uses immersion theory and transversality as usual, but there is no Whitney trick required, so it is easier. The algebraic vanishing of the $(-1)^m$ -quadratic formation guarantees, using a homology computation, that surgery to kill $K_m(f)$ simultaneously kills $K_{m+1}(f)$, and leaves $K_i(f)$ for $i \neq m, m + 1$ alone. Thus the surgeries give rise to a degree one normal bordism to a simple homotopy equivalence, again by Poincaré duality, and the Hurewicz and Whitehead theorems.

Note that the arguments of this section can also be used to show that a structure set is nonempty, by showing that the kernel of σ is nonempty. Also, exactness at the normal maps holds even if the structure set is empty: the preimage of $0 \in L_n^s(\mathbb{Z}[\pi_1(X)])$ is in this case empty.

28.13. Wall realisation

Suppose that the structure set of the Poincaré complex X is nonempty. We will define an action of the surgery obstruction group $L_{n+1}^s(\mathbb{Z}[\pi_1(X)])$ on $\mathcal{S}_{\text{CAT}}^s(X)$. The leftmost arrow in the surgery sequence refers to this action. Exactness at the structure set means, by definition, that two elements of the structure set are in the same orbit of this action if and only if they agree when mapped to $\mathcal{N}_{\text{CAT}}(X)$. The action will be defined using *Wall realisation*, a process we use to geometrically realise given elements of $L_{n+1}^s(\mathbb{Z}[\pi_1(X)])$. We describe the realisation separately when n is even and when n is odd, corresponding to the different definitions of the L groups.

28.14. Wall realisation when n is even.

Let $n = 2m \geq 4$, so that $n + 1 = 2m + 1$. The definition of Wall realisation uses the sphere embedding Theorem 28.1, and therefore for $n = 4$ requires that $\pi_1(X)$ be a good group. We start with a degree one normal map (M, f, ξ, b) to X , such that f is a simple homotopy equivalence, together with a given nonsingular $(-1)^m$ -quadratic formation. As noted earlier, every nonsingular $(-1)^m$ -quadratic formation is isomorphic to $(H_{(-1)^m}(P), P, G)$ for some finitely generated, free, based $\mathbb{Z}[\pi_1(X)]$ -module P and for some simple lagrangian G of $H_{(-1)^m}(P)$. Let k be the rank of P . Perform k surgeries on trivial, embedded copies of S^{m-1} in M . The *trace* of these surgeries consists of $M \times [0, 1]$ with k $(2m + 1)$ -dimensional m -handles $D^m \times D^{m+1}$ attached to the trivial S^{m-1} s. Choose framings on the circles such that this builds a cobordism W' over $X \times [0, 1/2]$ from $f: M \rightarrow X$ to $f': M' := M \#^k S^m \times S^m \rightarrow X$. The surgery kernel $K_m(f) = 0$ changes to $(K_m(f'), \lambda, \mu) \cong H_{(-1)^m}(P)$, the intersection form of $\#^k S^m \times S^m$. Here the summand P is identified with the submodule generated by the spheres $S^m \times \{\text{pt}\}$.

Now we use the sphere embedding Theorem 28.1, which uses immersion theory, transversality, and in the case $m = 2$ that $\pi_1(X)$ is good. The lagrangian $G \subseteq P \oplus P^* \cong K_m(f': M \#^k S^m \times S^m \rightarrow X)$ is a finitely generated, free, based submodule of $K_m(f')$. Represent the basis of G by framed, immersed spheres $\{f_1, \dots, f_k\}$ in $M \#^k S^m \times S^m$ with $\lambda(f_i, f_j) = 0$ for all $i, j = 1, \dots, k$ and $\mu(f_i) = 0$ for $i = 1, \dots, l$. Since the intersection form on $M \#^k S^m \times S^m$ is nonsingular, there is a collection of dual spheres $\{g_1, \dots, g_k\}$, also framed and immersed, such that $\lambda(f_i, g_j) = \delta_{i,j}$ for all i, j . This is necessary for applying the sphere embedding theorem in the case $n = 4$, but is not important for $n \geq 5$.

By the sphere embedding Theorem 28.1, the spheres $\{f_i\}$ are regularly homotopic to a collection of mutually disjoint, locally flat embedded spheres $\{f'_i\}$ with geometrically transverse spheres $\{\bar{g}_j\}$. The spheres $\{f'_i\}$ are framed since the spheres $\{f_i\}$ were. Use the spheres $\{f'_i\}$ as the data for surgery on $M \#^k S^m \times S^m$. The trace of this surgery is a cobordism W'' over $X \times [1/2, 1]$ from $M \#^k S^m \times S^m$ to another closed, CAT $(2m)$ -manifold M'' . The map to X extends because we perform surgery on classes that map to null-homotopic elements of X . The second surgery kills $K_m(f')$, but in a different way than how surgery on the generators of P

would kill it. The second surgery does not create new generators of $\pi_{m-1}(M'')$, again due to the transverse spheres. Observe that the normal data (ξ, b) can be extended across the cobordism W , since we performed surgery on compatibly framed spheres representing relative homotopy classes. Thus we have produced a degree one normal bordism (W, F, Ξ, B) from (M, f, ξ, b) to a new degree one normal map (M'', f'', ξ'', b'') . The resulting map $f'': M'' \rightarrow X$ is again a homotopy equivalence and moreover, a simple homotopy equivalence. This latter fact is proved in [Wal99, Theorem 6.5], but using an alternative definition of the groups $L_{n+1}^s(\mathbb{Z}[\pi_1(X)])$ and hence a slightly different, but equivalent, definition of the action on $\mathcal{S}_{\text{CAT}}^s(X)$.

By construction, the degree one normal map (W, F, Ξ, B) has surgery obstruction

$$\sigma(W, F, \Xi, B) = [(H_{(-1)^m}(P), P, G)] \in L_{n+1}^s(\mathbb{Z}[\pi_1(X)]).$$

28.15. Wall realisation when n is odd

Let $n = 2m + 1$, so that $n + 1 = 2m + 2 = 2(m + 1)$. We start with a degree one normal map (M, f, ξ, b) to X , such that f is a simple homotopy equivalence, together with a given nonsingular simple $(-1)^{m+1}$ -quadratic form $(P, \lambda, \mu) \in L_{2(m+1)}^s(\mathbb{Z}[\pi_1(X)])$. We attach $(m + 1)$ -handles $D^{m+1} \times D^{m+1}$ to $M \times \{1\} \subseteq M \times [0, 1]$, with attaching maps carefully chosen using the data of the form, λ and μ . This produces a degree one normal bordism from (M, f, ξ, b) to (M', f', ξ', b') , where the surgery obstruction of the normal bordism is the prescribed $(-1)^{m+1}$ -quadratic form. For details see [Wal99, Theorem 5.8].

28.16. Exactness at the structure set

Using Wall realisation we define the action of the surgery obstruction group $L_{n+1}^s(\mathbb{Z}[\pi_1(X)])$ on the structure set $\mathcal{S}_{\text{CAT}}^s(X)$. We start with an element of the structure set, a closed, CAT n -manifold M with a simple homotopy equivalence $f: M \rightarrow X$. We described in Section 28.2 how (M, f) determines a degree one normal map (M, f, ξ, b) to X . Apply Wall realisation to this and a representative of a given class in $L_{n+1}^s(\mathbb{Z}[\pi_1(X)])$ to obtain some (M'', f'', ξ'', b'') . The result of the action on (M, f) is defined to be $(M'', f'') \in \mathcal{S}_{\text{CAT}}^s(X)$.

This action is independent of the choice of realising $(n + 1)$ -manifold. Indeed, suppose (W, F, Ξ, B) and (W', F', Ξ', B') each realise $x \in L_{n+1}^s(\mathbb{Z}[\pi_1(X)])$ and are cobordisms from (M, f, ξ, b) to (N, g, θ, c) and (N', g', θ', c') respectively. Construct

$$(V, G, \Theta, C) := -(W, F, \Xi, B) \cup_{(M, f, \xi, b)} (W', F', \Xi', B'),$$

a cobordism from N to N' . The $(n + 1)$ -dimensional surgery obstruction of (V, G, Θ, C) vanishes, since it is the difference of the (equal) surgery obstructions of (W, F, Ξ, B) and (W', F', Ξ', B') . By the main theorem of odd dimensional surgery [Wal99], (V, G, Θ, C) is bordant relative to the boundary to a simple homotopy equivalence, proving that (N, g) and (N', g') are equal in the structure set $\mathcal{S}_{\text{CAT}}^s(X)$. A similar argument as above shows that equivalent forms/formations induce the same action on $\mathcal{S}_{\text{CAT}}^s(X)$ and thus we have a well defined action of $L_{n+1}^s(\mathbb{Z}[\pi_1(X)])$ on the structure set $\mathcal{S}_{\text{CAT}}^s(X)$.

Now we are ready to prove exactness at the structure set. This is stronger than exactness of pointed sets. Precisely, it means that the orbits of the action coincide with the preimages of singleton sets in $\mathcal{N}_{\text{CAT}}(X)$.

First observe that (M, f) and (M'', f'') determine the same class in $\mathcal{N}_{\text{CAT}}(X)$ because the elements (M, f, ξ, b) and (M'', f'', ξ'', b'') are degree one normally bordant via (W, F, Ξ, B) , by construction. We also need to argue that normally bordant homotopy equivalences are related by the action of $L_{n+1}^s(\mathbb{Z}[\pi_1(X)])$. Let (M, f) and (N, g) represent elements of $\mathcal{S}_{\text{CAT}}^s(X)$ and suppose that (W, F, Ξ, B) is a degree one normal bordism over X between the associated degree one normal maps (M, f, ξ, b) and (N, g, θ, c) . Let $\sigma(W, F, \Xi, B) \in L_{n+1}^s(\mathbb{Z}[\pi_1(X)])$ be the odd dimensional surgery obstruction of the cobordism. Realise $\sigma(W, F, \Xi, B)$ by a cobordism (W', F', Ξ', B') from (M, f, ξ, b) to some (M', f', ξ', b') using Wall realisation. We claim that

(N, g) and (M', f') are equal in the structure set, so that $[(N, g)]$ is in fact obtained from $[(M, f)]$ by the action of $L_{n+1}^s(\mathbb{Z}[\pi_1(X)])$. To see this claim, construct

$$(V, G, \Theta, C) := -(W, F, \Xi, B) \cup_{(M, f, \xi, b)} (W', F', \Xi', B;),$$

a cobordism from N to M' . The $(n + 1)$ -dimensional surgery obstruction of (V, G, Θ, C) vanishes, since it is the difference of the (equal) surgery obstructions of (W, F, Ξ, B) and (W', F', Ξ', B') , so (V, G, Θ, C) is bordant relative to the boundary to a simple homotopy equivalence, proving that (M', f') and (N, g) are equal in the structure set $\mathcal{S}_{\text{CAT}}^s(X)$.

In fact, by the $(n + 1)$ -dimensional CAT s -cobordism theorem, N and M' are CAT isomorphic, but we do not need this.

28.17. Exactness at $L_{n+1}^s(\mathbb{Z}[\pi_1(X)])$

Here is a quick sketch. If an element of the L group is in the image of $\mathcal{N}_{\text{CAT}}(X \times I, X \times \{0, 1\})$, then its action on the structure set changes M by a CAT-isomorphism, over X , and so the action is trivial. Note that the action is the same for any choice of normal bordism with surgery obstruction a fixed element x of $L_{n+1}^s(\mathbb{Z}[\pi_1(X)])$.

On the other hand, if the action is trivial, then the action on the identity produces a normal bordism between the identity and a homeomorphism. This is an element of $\mathcal{N}_{\text{CAT}}(X \times I, X \times \{0, 1\})$. Thus the stabiliser of the identity is the image of $\mathcal{N}_{\text{CAT}}(X \times I, X \times \{0, 1\})$.

28.18. The surgery sequence for manifolds with boundary

In many situations, a generalisation of the material from the previous sections to manifolds with nonempty boundary is required. Again fix a CAT, and let $n \geq 4$. If $n = 4$ assume $\text{CAT} = \text{TOP}$ and $\pi_1(X)$ is good. We describe the necessary modifications for the case of manifolds with boundary. For manifolds with boundary, the surgery sequence has the form

$$\mathcal{N}_{\text{CAT}}(X \times [0, 1], h \times \text{Id}_{[0,1]} \cup X \times \{0, 1\}) \xrightarrow{\sigma} L_{n+1}^s(\mathbb{Z}[\pi_1(X)]) \rightarrow \mathcal{S}_{\text{CAT}}^s(X, h) \rightarrow \mathcal{N}_{\text{CAT}}(X, h) \xrightarrow{\sigma} L_n^s(\mathbb{Z}[\pi_1(X)]).$$

We will define the terms, including h , below. Firstly, a n -dimensional *Poincaré pair* $(X, \partial X)$ is a finite CW complex X together with a subcomplex ∂X , an orientation character $w: \pi_1(X) \rightarrow \mathbb{Z}/2$, and a *fundamental class* $[X] \in H_n(X, \partial X; \mathbb{Z}^w)$, satisfying the following. Cap product induces simple chain homotopy equivalences

$$- \cap [X]: C^{n-*}(X, \partial X; \mathbb{Z}[\pi_1(X)]^w) \xrightarrow{\cong} C_*(X; \mathbb{Z}[\pi_1(X)]),$$

and

$$- \cap [X]: C^{n-*}(X; \mathbb{Z}[\pi_1(X)]^w) \xrightarrow{\cong} C_*(X, \partial X; \mathbb{Z}[\pi_1(X)]),$$

each connected component $\partial_i X$ of ∂X inherits the structure of an $(n - 1)$ -dimensional Poincaré complex with respect to the orientation character induced by w , and a fundamental class $[\partial_i X]$ given by the image of $[X]$ under the homomorphism $H_n(X, \partial X; \mathbb{Z}) \rightarrow H_{n-1}(\partial X; \mathbb{Z}) \cong \bigoplus_i H_{n-1}(\partial_i X; \mathbb{Z})$.

For any compact, CAT n -manifold M , oriented if orientable, the pair $(M, \partial M)$ can be given the structure of a Poincaré pair in a unique way up to simple homotopy equivalence [KS77b, Essay III, Theorem 5.13].

Fix an n -dimensional Poincaré pair $(X, \partial X)$. Working ‘relative to the boundary’ means that we fix an $(n - 1)$ -dimensional CAT manifold $N = \bigsqcup_i N_i$ with the same number of connected components as ∂X , and a map $h: N \rightarrow \partial X$ that restricts to a degree one normal map on each connected component. We moreover insist that h induces a simple chain homotopy equivalence $h_*: C_*(N_i; \mathbb{Z}[\pi_1(X)]) \rightarrow C_*(\partial_i X; \mathbb{Z}[\pi_1(X)])$ for each connected component. The assumption that h is a normal map is required to define a relative normal map set. The $\mathbb{Z}[\pi_1(X)]$ coefficient chain homotopy equivalence is required so that the intersection form on the surgery kernel is nonsingular and the surgery obstruction map σ is well-defined.

The *relative structure set* $\mathcal{S}_{\text{CAT}}^s(X, h)$ consists of equivalence classes of pairs (M, f) , where M is a compact, CAT n -manifold with boundary N , and $f: M \rightarrow X$ is a simple homotopy equivalence such that $h = f|_{\partial M}: \partial M \rightarrow \partial X$. The equivalence relation is defined by setting $(M, f) \sim (M', f')$ when there exists a cobordism $F: W \rightarrow (X, \partial X) \times [0, 1]$ with boundary $\partial(W, F) = -(M, f) \cup_{N \times \{0\}} ((N, h) \times [0, 1]) \cup_{N \times \{1\}} (M', f')$ such that F is a simple homotopy equivalence. We say that (M, f) and (M', f') are *cobordant* over X . Such a cobordism W is in particular an s -cobordism relative to the boundary N .

Since $h: N \rightarrow \partial X$ is a degree one normal map, this includes the information of a choice of lift of the Spivak normal fibration to $BTOP$ for each connected component $\partial_i X$ of ∂X . The set of *relative normal maps* $\mathcal{N}_{\text{CAT}}(X, h)$ is the set of degree one normal bordism classes of *degree one normal maps over X relative to h* . These are, by definition, quadruples (M, f, ξ, b) , where M is a compact, CAT n -manifold with boundary N , the map $f: M \rightarrow X$ has degree one and restricts to h on the boundary, and (ξ, b) is stable normal data, covering f and restricting to the given lifts of the Spivak normal fibration on ∂X .

With these modifications, the arguments, definitions, and descriptions of Section 28.1 apply to the interior of M and the exact sequence given above may be constructed similarly.

28.19. Topological manifolds are like high dimensional smooth and PL manifolds, only more so.

The title of this section is a quote from slides of Andrew Ranicki. We think that what he meant was that smooth manifolds, of dimension at least five, admit a remarkably close relation to homotopy theory and algebra, via surgery theory. However there are complications in the smooth category, principally arising from exotic spheres and from Rochlin's theorem, that muddy the waters. In the topological category, the correspondence between geometry and algebra is crisper and more elegant, whence "only more so". In this section we will try to explain the slogan in a precise way.

In the topological category, the following are true. We will not explain what they mean here, but they can be thought of as suggestions for further reading.

- (1) The Poincaré conjecture holds in all dimensions.
- (2) The Schoenflies conjecture holds in all dimensions.
- (3) Orientation preserving homeomorphisms of S^n are isotopic to the identity.
- (4) The Alexander trick works.
- (5) The surgery obstruction map for the sphere is a bijection.
- (6) The surgery exact sequence is a sequence of abelian groups.
- (7) The simply-connected surgery exact sequence is a collection of short exact sequences.
- (8) Knots $S^{n-k} \subset S^n$ for $k \geq 3$ are unknotted.
- (9) Sullivan periodicity: $\Omega^4(\mathbb{Z} \times G/\text{TOP}) \simeq \mathbb{Z} \times G/\text{TOP}$.
- (10) Siebenmann periodicity.
- (11) Topological Rigidity: the Borel conjecture that every homotopy equivalence between closed aspherical n -manifolds is homotopic to a homeomorphism holds in many cases.
- (12) Topological surgery in dimension 4.
- (13) The total surgery obstruction gives a criterion for a Poincaré complex to be homotopy equivalent to a topological manifold.

Part X

Double suspension theorem, triangulations, and homology manifolds

The double suspension of the Mazur homology sphere

Fadi Mezher

The main objects of this chapter are *homology spheres*, which are defined below.

Definition 29.1. A manifold M of dimension n is called a homology n -sphere if it has the same homology groups as S^n ; that is,

$$H_k(M) = \begin{cases} \mathbb{Z} & \text{if } k \in \{0, n\} \\ 0 & \text{otherwise} \end{cases}$$

A result of J.W. Cannon in [Can79b] establishes the following theorem

THEOREM 29.2 (Double Suspension Theorem). *The double suspension of any homology n -sphere is homeomorphic to S^{n+2} .*

This, however, is beyond the scope of this text. We will, instead, construct a homology sphere, the *Mazur homology 3-sphere*, and show the double suspension theorem for this particular manifold. However, before beginning with the proper content, let us study the following famous example of a nontrivial homology sphere.

Example 29.3. . Let I be the group of (orientation preserving) symmetries of the icosahedron, which we recall is a regular polyhedron with twenty faces, twelve vertices, and thirty edges. This group, called the icosahedral group, is finite, with sixty elements, and is naturally a subgroup of $\text{SO}(3)$. It is a well-known fact that we have a 2-fold covering $\xi : \text{SU}(2) \rightarrow \text{SO}(3)$, where $\text{SU}(2) \cong S^3$, and $\text{SO}(3) \cong \mathbb{R}P^3$. We then consider the following pullback diagram

$$\begin{array}{ccc} S^0 & & S^0 \\ \downarrow & & \downarrow \\ \tilde{I} := \iota^*(\text{SU}(2)) & \xrightarrow{\quad} & \text{SU}(2) \\ \iota^*\xi \downarrow & & \downarrow \xi \\ I & \xrightarrow{\quad} & \text{SO}(3) \end{array}$$

Then, \tilde{I} is also a group, where the multiplication is given by the lift of the map $\mu \circ (\iota^*\xi \times \iota^*\xi)$, where μ is the multiplication in I . Thus, \tilde{I} defines a subgroup of the compact Lie group $\text{SU}(2)$, called the binary (or extended) icosahedral group. Furthermore, it is clear that this group consists of 120 elements; it can be further shown that $\tilde{I} = \langle s, t \mid (st)^2 = s^3 = t^5 \rangle$. We now form the space $P^3 = \text{SU}(2)/\tilde{I}$, called the *Pioncaré homology sphere*, and note that it is itself a Lie group, as being the quotient of a Lie group by a finite subgroup. By covering space theory (more precisely, Proposition 1.40 from [Hat01]), one can show that $\pi_1 P^3 \cong \tilde{I}$. Another way to see this is via a theorem of Gleason (cf. Corollary 1.4 in [Coh]), which states that $p : \text{SU}(2) \rightarrow P^3$ is a principal \tilde{I} -bundle. Since this principal bundle has discrete fibre, it is a covering space with the structure group being isomorphic to the fundamental group. That is, $\pi_1(P^3) \cong \tilde{I}$.

It is a well-known fact that the binary icosahedral group is a perfect group, i.e. $\tilde{I} = [\tilde{I}, \tilde{I}]$. From this, it follows that $H_1(P^3) \cong \pi_1^{ab}(P^3) = 0$. Furthermore, since P^3 is a Lie group, Poincaré duality holds, so that we get an isomorphism $H_2(P^3) \cong H^1(P^3)$; by the universal coefficient theorem, it also follows that $H^1(P^3) \cong \text{Hom}(H_1(P^3), \mathbb{Z}) = 0$, so that $H_2(P^3) = 0$. Furthermore, P^3 is clearly connected, and hence $H_3(P^3) \cong \mathbb{Z}$. Thus, it is a homology sphere.

Remark: There are at least eight different constructions of that manifold, as found in [KS79]. The above description is the most accessible one among them.

The upshot of the above example is that homology equivalence does not classify spaces up to homotopy equivalence; indeed, P^3 and S^3 are homology equivalent, even though S^3 is simply connected, while $\pi_1(P^3) \cong \tilde{I} \neq 0$.

29.1. Some technical lemmata

We now prove some technical lemmata, the first of which serves as a preliminary reduction of the double suspension theorem to proving that the double suspension is a manifold, while the second gives a criterion for a manifold to be a homology n -sphere. The third one will be used to show that the 4-manifold we construct in the next section is indeed contractible, so that the conditions of Lemma 29.6 are met.

LEMMA 29.4. *If a compact manifold of dimension n can be written as $M = U_1 \cup U_2$ where $U_1 \cong U_2 \cong \mathbb{R}^n$, then $M \cong S^n$.*

Proof. By invariance of domain, we note that any U_1 and U_2 as in the above are open in M . Denote by φ the homeomorphism $\varphi : U_2 \rightarrow \mathbb{R}^n$. Observe that $M \setminus U_1$, being a closed set in the compact manifold M , is itself compact. Then, $\varphi(M \setminus U_1)$ is a compact subset of \mathbb{R}^n , so that, in particular, it is bounded in \mathbb{R}^n . Consider three closed, n -dimensional concentric balls in \mathbb{R}^n , containing $\varphi(M \setminus U_1)$ in their interiors, and let D be the middle ball. Then, $\varphi^{-1}(\partial D) \subseteq U_1$ is a bicollared $(n-1)$ -dimensional sphere in U_1 . Thus, the Schoenflies theorem tells us that $M \setminus \varphi^{-1}(\text{int}(D))$ is itself homeomorphic to D^n . Consequently, we have shown that M can be written as a union of two homeomorphic copies of the standard disc D^n , attached along their boundaries. By the Alexander trick, we may extend the homeomorphism $\varphi^{-1}|_{\partial D}$ to homeomorphisms of the discs themselves, and as such, $M \cong S^n$. \square

COROLLARY 29.5. *If the suspension ΣX of any topological space X is a compact n -manifold, then $\Sigma X \cong S^n$.*

Proof. Consider the coordinate neighborhoods U_1 and U_2 around the two suspension points of ΣX , which exist since we assumed that ΣX is a manifold. Then, by stretching these two neighborhoods along the $[-1, 1]$ coordinate in $\Sigma X = (X \times [-1, 1]) / \sim$, we are reduced to the setting of Lemma 29.4. Thus, $\Sigma X \cong S^n$, as claimed. \square

LEMMA 29.6. *The boundary of any compact, contractible n -manifold is an $(n-1)$ -homology sphere.*

Proof. We first recall that any simply connected manifold is orientable. It follows that M is a compact, orientable manifold with boundary, and thus Poincaré-Lefschetz duality holds, so that we have isomorphisms $H_k(M, \partial M) \cong H^{n-k}(M)$, for all $k \in \mathbb{N}$. Furthermore, since M is contractible, it follows that $H^k(M)$ is trivial in all dimensions except 0, where it is infinite cyclic. Inspecting the homology long exact sequence of the pair $(M, \partial M)$, we reach the following conclusions:

- For all $k > 1$, the fact that $H_k(M) = H_{k-1}(M) = 0$ implies that the connecting homomorphism $\partial_* : H_k(M, \partial M) \rightarrow H_{k-1}(\partial M)$ is an isomorphism; thus, $H_{n-1}(\partial M) \cong \mathbb{Z}$, while $H_k(\partial M) = 0$ for all $k \notin \{0, n-1\}$
- For $k = 1$, we have the following exact sequence:

$$0 = H_1(M, \partial M) \xrightarrow{\partial_*} H_0(\partial M) \xrightarrow{\iota_*} H_0(M) \xrightarrow{q_*} H_0(M, \partial M) = 0$$

Thus, ι_* is an isomorphism between $H_0(\partial M)$ and $H_0(M) \cong \mathbb{Z}$. □

LEMMA 29.7. *If a manifold M has a handle decomposition, then it is homotopy equivalent to a CW-complex whose cells are in bijection with the handles of M .*

Proof. The proof is rather straightforward: for every k -handle $D^k \times D^{n-k}$, attached via $\varphi_k : (\partial D^k) \times D^{n-k} \rightarrow M_{k-1}$, we contract D^{n-k} to its center 0; the resulting CW-complex will have, as attaching maps, the restriction of the handle attachments, namely $\varphi_k|_{D^k \times \{0\}}$. It then follows readily that the above two spaces are homotopy equivalent. □

29.2. Constructions

In light of Lemma 29.6, the Mazur homology 3-sphere will be defined as the boundary of a compact, contractible 4-manifold. This 4-manifold will be described via a handle decomposition using a 0-handle, a 1-handle, and a 2-handle. Let B_1 and B_2 be two disjoint 3-balls in ∂D^4 , where D^4 is the 0-handle, and let h_1 and h_2 denote the homeomorphisms $h_i : D^3 \rightarrow B_i$. This then yields a map $f = h_1 \sqcup h_2 : S^0 \times D^3 \rightarrow B_1 \sqcup B_2$; we now form the manifold $D^4 \cup_f (D^1 \times D^3)$, which is readily seen to be the manifold $S^1 \times D^3$. This is represented in the following illustration:

To attach the 2-handle onto the above manifold, we first consider the following inclusions:

$$S^1 \times D^2 \hookrightarrow S^1 \times S^2 \hookrightarrow S^1 \times D^3$$

The first inclusion is the result of viewing D^2 as one of the hemispheres of S^2 , while the second follows from the fact that $\partial D^3 = S^2$; both maps are the identity on the S^1 factor. Thus, we may view $S^1 \times D^2$ as a subspace of $\partial(S^1 \times D^3)$. Let Γ_0 be the standard circle $S^1 \times \{0\}$ in $S^1 \times D^2$, and let Γ_1 be the knot embedded in $S^1 \times D^2 \subset \partial(S^1 \times D^3)$ shown in the following figure, taken from [Fer]

Let N be a thickened neighborhood of Γ_1 , which is clearly homeomorphic to $S^1 \times D^2$. On the boundary of N , we have a pushoff β of Γ_1 , which has linking number $lk(\Gamma_1, \beta) = 0$ with Γ_1 . Consider the homeomorphism $\varphi : S^1 \times D^2 \rightarrow N$, mapping Γ_0 to Γ_1 , and mapping a circle $S^1 \times *$ on the boundary of $S^1 \times D^2$ to a knot of the above type, i.e. having linking number 0 with Γ_1 . Note that the attaching map of the 2-handle described above is an orientation preserving homeomorphism, as shown in Lemma 29.8. We now form the 4-manifold $W^4 := (S^1 \times D^3) \cup_\varphi (D^2 \times D^2)$.

LEMMA 29.8. $\varphi : S^1 \times D^2 \xrightarrow{\cong} N$ is an orientation preserving homeomorphism.

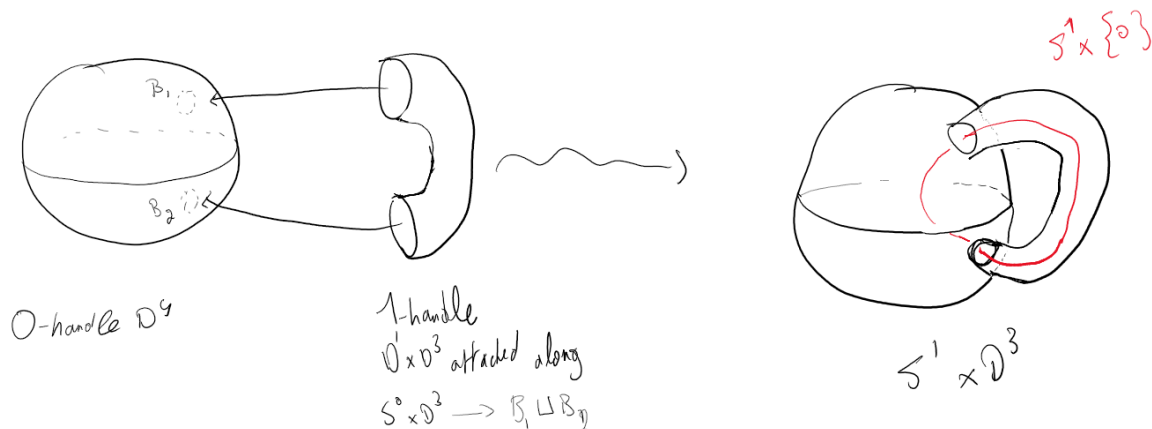

FIGURE 29.1. Attaching of the 1-handle.

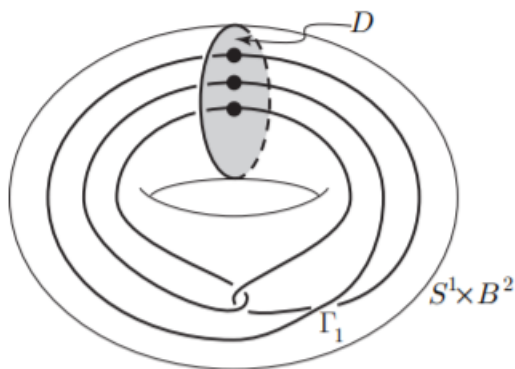

FIGURE 29.2. The Mazur link Γ_1 .

Proof. By the relative Künneth formula, we get isomorphisms

$$\begin{aligned} H^3(S^1 \times D^2, \partial(S^1 \times D^2)) &= H^3(S^1 \times D^2, (\emptyset \times D^2) \cup (S^1 \times S^1)) \\ &\cong \bigoplus_{i+j=3} (H^i(S^1) \otimes_{\mathbb{Z}} H^j(D^2, S^1)) \\ &\cong H^1(S^1) \otimes_{\mathbb{Z}} H^2(S^2) \end{aligned}$$

Furthermore, we have that $H^1(S^1) \otimes_{\mathbb{Z}} H^2(S^2) \cong H^1(S^1)$, via the map $x \mapsto x \otimes 1$. Thus, the degree of the map φ is determined by its restriction onto Γ_0 ; that is, we have the following diagram.

$$\begin{array}{ccc} H^3(S^1 \times D^2, \partial(S^1 \times D^2)) & \xrightarrow{\varphi^*} & H^3(S^1 \times D^2, \partial(S^1 \times D^2)) \\ \cong \downarrow & & \downarrow \cong \\ H^1(S^1) & \xrightarrow{(\varphi|_{\Gamma_0})^*} & H^1(S^1) \end{array}$$

A standard computation shows that the degree of the lower horizontal map is the identity; thus, the upper map also has degree 1, and hence is orientation preserving. \square

LEMMA 29.9. W^4 is contractible.

Proof. By Lemma 29.7, W^4 is homotopy equivalent to a 2 dimensional CW-complex X ; this CW-complex is constructed using one 0-cell, one 1-cell, and one 2-cell. The 2-cell is attached to the circle S^1 via a degree one map $\tilde{\varphi}$ wrapping $\partial D^2 = S^1$ around the 1-skeleton twice in one direction, and once in the opposite direction, courtesy of the fact that the knot Γ_1 winds twice in one direction, and once in the opposite direction. This CW-complex can be easily shown to be contractible, as follows. All its reduced homology groups are trivial, since its cellular cochain complex ends takes the following form

$$0 \rightarrow \mathbb{Z} \xrightarrow{id} \mathbb{Z} \xrightarrow{\times 0} \mathbb{Z} \rightarrow 0$$

In the above, the second map is the identity as a result of the local degree formula, and the third map is trivial since the space is connected. Furthermore, a presentation of the fundamental group is given by $\pi_1(X) = \langle a \mid a^2 a^{-1} = 1 \rangle$, which is clearly the trivial group. Consequently, by successive iterations of the Hurewicz theorem, it follows that $\pi_n(X) = 0$, for all $n \geq 1$. Thus, the map $X \rightarrow *$ is a weak homotopy equivalence, so that contractibility follows from the Whitehead theorem. \square

As a consequence of Lemma 29.6, it follows that $H^3 := \partial W^4$ is a homology 3-sphere, called the Mazur homology 3-sphere. We note that in the above, the precise choice of the attaching map φ is irrelevant, as long as $\varphi|_{\Gamma_0}$ winds, homotopically, once around $S^1 \times D^2$.

It is noteworthy to mention that a presentation of $\pi_1 H^3$ is given by

$$\pi_1 H^3 = \langle a, b \mid a^7 = b^5, b^4 = a^2 b a^2 \rangle$$

Mazur showed this group is nontrivial, as stated in [Dav07]. Thus, H^3 is not homotopy equivalent to S^3 .

29.3. The Giffen disc

In this section, we prove that W^4 contains a 2-cell B inside its interior, called the *Giffen disc*, which will play a vital role in the proof of the double suspension theorem, in this setting. Furthermore, we show that this 2-cell is a *pseudo-spine*, as defined below.

Definition 29.10. A compact subset X of a manifold with boundary M is called a pseudo-spine if $M \setminus X \cong \partial M \times [0, 1)$.

We now construct the Giffen disc. Begin by cutting $S^1 \times D^2$ along the disc D indicated in Figure 29.2, and let $\{B_i^2\}_{i \in \mathbb{N}}$ be a countable collection where each of the B_i 's is a cylinder resulting from the above cutting. Form $D^2 \times [0, \infty)$ by attaching $B_i^2 \times [i - 1, i]$ to $B_{i+1}^2[i, i + 1]$ in such a way that the curves inside the cylinders align; finally, let C^3 be the one point compactification of the above space, as represented in the Figure 29.3, taken from [Dav07]

Let $L = (\bigcup_{i \in \mathbb{N}} L_i) \cup \{\infty\}$, where L_i are as in the above figure. Clearly, C^3 is a 3-cell (hence the notation), and L has two connected components; furthermore, the component of ∞ is a Fox-Artin arc, so that, as a consequence, the embedding $L \hookrightarrow \mathbb{R}^3$, resulting from the standard embedding $C^3 \hookrightarrow \mathbb{R}^3$, is wild. Let $\sigma : C^3 \rightarrow C^3$ be the shift homeomorphism defined as $\sigma(b, t) = (b, t + 1)$, and $\sigma(\infty) = \infty$. Form the mapping torus $T(\sigma) = C^3 \times \mathbb{I} / \sim$, where \sim identifies points $(x, 0)$ with $(\sigma(x), 1)$; additionally, let Ω be the mapping torus of $\sigma|_L : L \rightarrow L$. We first note that $T(\sigma)$ is homeomorphic to $D^3 \times S^1$; to see this, observe that $C^3 \times \mathbb{I} / \sim$ only

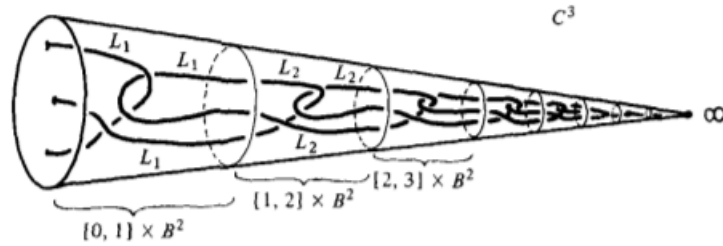

FIGURE 29.3. Cone containing a Fox-Artin arc.

skips $B_1^2 \times [0, 1]$, which can be homeomorphically "flattened", whereby we get a homeomorphism $T(\sigma) \cong C^3 \times \mathbb{I} / (C^3 \times \{0\} \sim C^3 \times \{1\}) \cong C^3 \times S^1 \cong D^3 \times S^1$. We further claim that Ω is an annulus $S^1 \times \mathbb{I}$. This follows after straightening both components of L , since $L \cong I_1 \sqcup I_2$, where each I_i is an interval (however, it is of course not ambiently isotopic to it, since the Fox-Artin arc is wild). Then, Ω is the quotient space represented in the following figure.

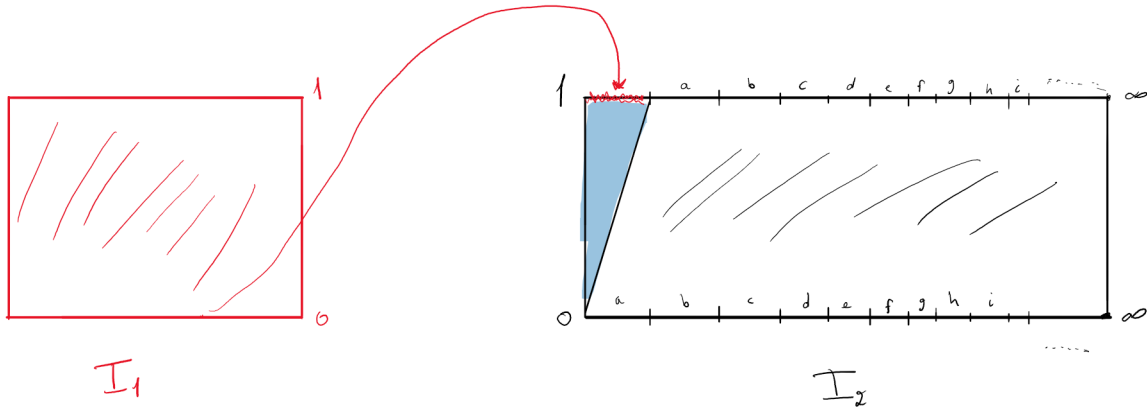

FIGURE 29.4. Quotient space homeomorphic to the mapping torus Ω .

In the figure, I_2 is partitioned into countably infinitely many subintervals, where the partition points lie on the intersection of the middle part of the Fox-Artin arc with the discs $B_i^2 \times \{i\}$ in the above cone. Then, $I_1 \times \{0\}$ is identified with a (strict) subinterval of the first interval in this partition; furthermore, due to the shift map, the subintervals $[i - 1, i] \times \{0\} \subset I_2 \times [0, 1]$ are identified with the shifted ones, namely $[i, i + 1] \times \{1\} \subset I_2 \times [0, 1]$; these are represented on the above figure by shifted Latin letters. It then follows easily that Ω is an annulus. Consider the natural embedding $\Omega \hookrightarrow T(\sigma)$, resulting from the fact that $L \subset C^3$; this embedding is such that $\Omega \cap \partial T(\sigma) = \partial \Omega$. It is imperative to note that $\partial \Omega$ consists of a standard circle on one of its connected components, and of a Mazur link Γ_1 on the other; this can be seen geometrically from the figure of the cone C^3 above, where the standard circle results from the ∞ point. This embedding (or more precisely a part thereof) is represented in Figure 29.5.

In $W^4 = (S^1 \times D^3) \cup h$, where h is a 2-handle such that $h \cap (S^1 \times D^3)$ is a neighborhood as occurring in the above construction, and where $\Gamma_1 = \partial D^2 \times \{0\} \subset D^2 \times D^2 = h$, let $B := \Omega \cup (D^2 \times \{0\})$. By the Alexander trick, B is easily seen to be a 2-cell in $int(W^4)$.

THEOREM 29.11. *B is a pseudo-spine of W^4 .*

Before attempting to prove Theorem 29.11, we will have a detour to see some results from regular neighborhoods and piecewise-linear topology.

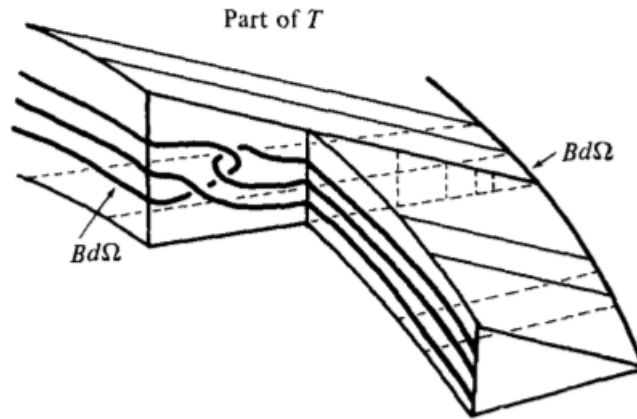

FIGURE 29.5. Transversal cut of $T(\sigma)$.

29.4. Regular Neighborhoods

In this section, we will list some definitions and results from PL-topology and regular neighborhoods, without proofs.

Definition 29.12. A Δ -complex structure on a space X is a collection of maps $\{\sigma_\alpha : \Delta^{n_\alpha} \rightarrow X\}$ from standard simplices to X , where n_α depends on α , that satisfy the following

- (1) The restriction $\sigma_\alpha|_{\text{int}(\Delta^{n_\alpha})}$ is injective, and each point of X lies in the image of exactly one such restriction $\sigma_\alpha|_{\text{int}(\Delta^{n_\alpha})}$.
- (2) Each restriction of σ_α onto the faces of Δ^n is one of the maps $\sigma_\beta : \Delta^{n-1} \rightarrow X$, where we identify Δ^{n-1} with a face of Δ^n by a linear homeomorphism.
- (3) A set $A \subset X$ is open if and only if $\sigma_\alpha^{-1}(A)$ is open in Δ^n for all α .

We will, however, not need this generality; our study restricts to $X \subset \mathbb{R}^n$. A finite collection K of simplices in \mathbb{R}^n is called a simplicial complex if for $\sigma \in K$, and $\tau < \sigma$, where $<$ means “is a subface of”, then $\tau \in K$, and if $\sigma, \tau \in K$, then $\sigma \cap \tau < \sigma$ and $\sigma \cap \tau < \tau$. In the above case, the geometric realisation of K is by definition $|K| = \bigcup_{\sigma \in K} \sigma$, and is called a *polyhedron*, while K is a *triangulation* of $|K|$.

Definition 29.13. A locally finite simplicial complex is a (possibly infinite) collection K of simplices $\sigma \subset \mathbb{R}^n$ such that:

- (1) If $\sigma \in K$ and $\tau < \sigma$, then $\tau \in K$.
- (2) If $\sigma, \tau \in K$, then $\sigma \cap \tau < \sigma$ and $\sigma \cap \tau < \tau$.
- (3) Every point of K has an open cover that intersects only finitely many of the simplices of K non trivially.

Two disjoint simplexes $\sigma, \tau \subset \mathbb{R}^n$ are said to be *joinable* if there exists a simplex γ that is spanned by their vertices. In this setting, σ and τ are said to be opposite faces of γ , and γ is called the join of σ and τ , denoted $\gamma = \sigma * \tau$. We remark that we will later discuss a more general operation on topological spaces, called join, not to be confused with the one here. Two finite simplicial complexes K, L are said to be joinable if all $\sigma \in K$ and $\tau \in L$ are joinable, and if for $\sigma, \sigma' \in K$ and $\tau, \tau' \in L$, we have that $\sigma * \tau \cap \sigma' * \tau'$ is a common face of $\sigma * \tau$ and $\sigma' * \tau'$. We now have reached the definition which was behind this entire excursion into PL-topology.

Definition 29.14. — Let K be a simplicial complex, and let L be a subcomplex. We say that there is an elementary collapse of K onto L if $K \setminus L$ consists of two simplexes A and B such that $A = a * B$, where a is a vertex of A . Thus, $|K| = |L| \cup A$, and $|L| \cap A = a * \partial B$.

- The complex K is said to collapse to the subcomplex L if there is a finite sequence of elementary collapses that eventually land in L .
- If P is a polyhedron in a PL manifold M , then N is a regular neighborhood of P if
 - (1) N is a closed neighborhood of P ;
 - (2) N is a PL manifold;
 - (3) N collapses to L .

We now quote the regular neighborhood theorem, as used in the proof of theorem 6.

THEOREM 29.15 (Regular Neighborhood Theorem). *Let P be a polyhedron in the PL manifold M . Then, there exists a regular neighborhood N of P in M , that is unique up to PL homeomorphism, rel. P .*

29.5. Joins

The current section is devoted to a discussion on joins of topological spaces. This operation is quite interesting in of its own, as it is used in the Milnor construction of universal G -bundles; furthermore, it is quite relevant to our discussion here.

Definition 29.16. Let X and Y be two topological spaces. We define $X * Y$ as the space $(X \times T \times \mathbb{I}) / \sim$ where \sim identifies the following points:

- $(x, y_1, 0) \sim (x, y_2, 0)$, for all $x \in X$, and $y_1, y_2 \in Y$;
- $(x_1, y, 1) \sim (x_2, y, 1)$, for all $x_1, x_2 \in X$ and $y \in Y$.

The first result that we will prove is the fact that joins behave nicely for spheres, in the following sense.

LEMMA 29.17. $S^n * S^m \cong S^{n+m+1}$.

Proof. Define the map $\varphi: S^n \times S^m \times \mathbb{I} \rightarrow S^{n+m+1}$, mapping $(x, y, t) \mapsto x \cos \frac{\pi t}{2} + y \sin \frac{\pi t}{2} \in \mathbb{R}^{n+1} \times \mathbb{R}^{m+1}$ which has norm 1, i.e. $\varphi(x, y, t) \in S^{n+m+1}$. First, note that for $y_1, y_2 \in S^m$, we have $\varphi(x, y_1, 0) = \varphi(x, y_2, 0) = x$, while for $x_1, x_2 \in S^n$, we also have $\varphi(x_1, y, 1) = \varphi(x_2, y, 1)$. Thus, φ respects the equivalence relation on $S^n * S^m$, so that φ descends to the quotient to a map $\tilde{\varphi}: S^n * S^m \rightarrow S^{n+m+1}$, such that $\varphi = \tilde{\varphi} \circ q$, where q is the quotient map. We note that the map φ is surjective. Indeed, let $z \in S^{n+m+1}$. We first distinguish two cases; if z has all coordinates of one of the factors \mathbb{R}^{n+1} or \mathbb{R}^{m+1} equal to zero when z is seen as an element of \mathbb{R}^{n+m+2} . Let $x_z = proj_{n+1}(z)$, and $y_z = proj_{m+1}(z)$ be the projections in the product $\mathbb{R}^{n+1} \times \mathbb{R}^{m+1}$. Then, we have that $z = \varphi(x_z, y, 0)$ (for arbitrary y) or $z = \varphi(x, y_z, 1)$ (for arbitrary x). In the second case, both x_z and y_z are nonzero. Then, we have that $|x|^2 + |y|^2 = 1$, so that there exists a unique $t \in (0, 1)$ such that $|x|^2 = \cos^2 \frac{\pi t}{2}$ and $|y|^2 = \sin^2 \frac{\pi t}{2}$, with both non zero. In that setting, it is easy to see that $\varphi(\frac{x}{\cos \frac{\pi t}{2}}, \frac{y}{\sin \frac{\pi t}{2}}, t) = z$, and hence surjectivity of φ . Since $\varphi = \tilde{\varphi} \circ q$, it follows that $\tilde{\varphi}$ is also surjective.

For injectivity, we note that the only points of $z \in S^{n+m+1}$ that have $|\varphi^{-1}(z)| > 1$ are those points such that $x_z = 0$ or $y_z = 0$, each having preimages $\{x_z\} \times S^m \times \{0\}$ and $S^n \times \{y_z\} \times \{1\}$. These are precisely those sets that \sim identifies, and hence $\tilde{\varphi}$ is also injective, and thus a bijective continuous map. Finally, note that $S^n * S^m$ is a compact space, as being image of a compact space, while S^{n+m+1} is compact. By the compact-Hausdorff lemma, this continuous bijective map is actually a homeomorphism, and thus $S^n * S^m \cong S^{n+m+1}$. □

The following lemma is the main reason why we included this section in this text:

LEMMA 29.18. For any topological space X , $\Sigma X \cong S^0 * X$. By associativity of the join operator, it then follows that $\Sigma^2 X \cong (S^0 * S^0) * X \cong S^1 * X$.

Proof. Write $S^0 = \{\alpha, \beta\}$. The proof follows easily after unraveling what \sim does in this particular setting. First, $S^0 \times X \times \mathbb{I}$ is homeomorphic to a disjoint union of two cylinders $X \times \mathbb{I}$, which we write as $(X \times \mathbb{I})_\alpha \sqcup (X \times \mathbb{I})_\beta$. Then, \sim first identifies all points $(\alpha, x, 0) \sim (\alpha, x', 0)$ and $(\beta, x, 0) \sim (\beta, x', 0)$, so collapses the 0-th part of both cylinders to a point. Thus, we get a disjoint union of two cones over X . Then, we identify the points $(\alpha, x, 1) \sim (\beta, x, 1)$, i.e. we glue the full part of the cone together via the identity. The resulting space is clearly the suspension of X , as being homeomorphic to $(X \times [0, 2]) / (X \times \{0\}, X \times \{2\})$. Below is an illustration of the proof. □

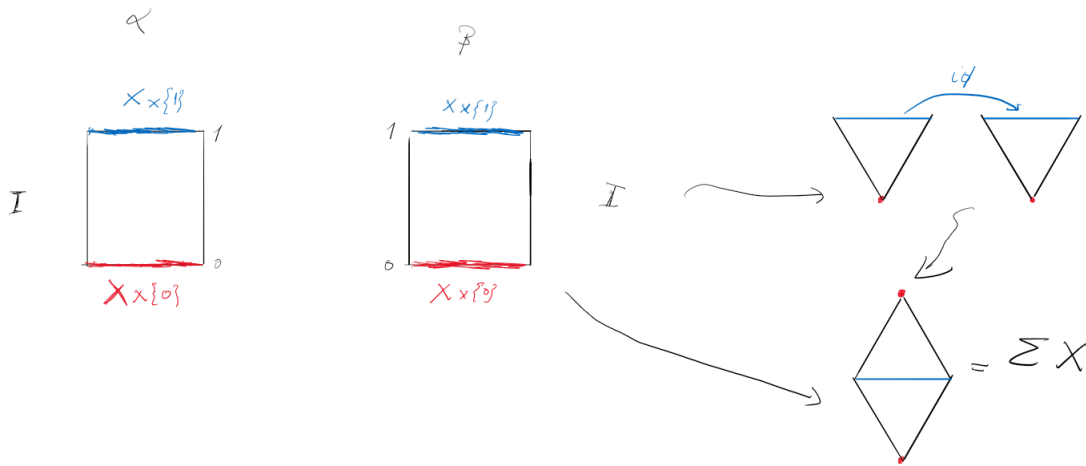

FIGURE 29.6. Visual representation of the above proof

In our situation, we note that $\Sigma^2 H^3 = (H^3 \times \mathbb{I} \times \mathbb{I}) / \sim$, where \sim identifies the sets $\{H^3 \times \{0\} \times \{t\}\}_{t \in [0,1]}$, $\{H^3 \times \{1\} \times \{t\}\}_{t \in [0,1]}$, $H^3 \times \mathbb{I} \times \{0\}$ and $H^3 \times \mathbb{I} \times \{1\}$ each to a point. Define $\Gamma \subset \Sigma^2 H^3$ as being the following set, where q denotes the quotient map

$$\Gamma := q\left(\bigcup_{t \in [0,1]} H^3 \times \{0\} \times \{t\}\right) \cup \left(\bigcup_{t \in [0,1]} H^3 \times \{1\} \times \{t\}\right) \cup (H^3 \times \mathbb{I} \times \{0\}) \cup (H^3 \times \mathbb{I} \times \{1\})$$

This set is called the *suspension circle*, for obvious reasons. Note that away from this set, the topology of the set $H^3 \times (0, 1) \times (0, 1)$ is unaltered, as the quotient does not affect it, so that on these points, we do have a manifold of dimension 5. By lemma 1, the proof of the double suspension theorem for the Mazur homology 3-sphere would follow from showing that the points in Γ are also manifold points, i.e. have neighborhoods homeomorphic to \mathbb{R}^5 . This, however, is not as simple as it may sound. It will use the following Proposition 29.19, Theorem 29.11 (which is yet to be proved), and a theorem by Bryant which we will be stated without proof.

PROPOSITION 29.19. Γ is locally homeomorphic to $\text{cone}(H^3) \times \mathbb{R}$, in the sense that for all $x \in \Gamma$, there exists a neighborhood \mathcal{U} of x in $\Sigma^2 H^3$ such that $\mathcal{U} \cong \text{cone}(H^3) \times \mathbb{R}$.

Proof. Let $\alpha \in \Gamma \subset \Sigma^2 H^3$, which is an element of the form $[x, t, s]$, where $[\]$ denotes the equivalence class under the relation \sim . In this setting, we need to distinguish two cases: $s \notin \{0, 1\}$, and $s \in \{0, 1\}$.

In the first case, we may assume $t = 0$, as the case $t = 1$ follows with the same proof. We view $X \times \mathbb{I} \times \{s\}$ as a copy of ΣX , along the transversal cut at s . Let $\text{cone}(x)$ be the cone $p(X \times [0, \varepsilon])$,

for $0 < \varepsilon < 1$, where p is the quotient map $p : X \times \mathbb{I} \rightarrow \Sigma X$, centered at that x , which is clearly an open set containing $(x, 0)$. Since we assumed that $s \notin \{0, 1\}$, then the topology at that point coincides with the topology of $\Sigma X \times \mathbb{I}$. Let $\delta < \min(s, 1 - s)$, chosen so that the following open neighborhood avoids the suspension points, namely the open neighborhood of α given by $\text{cone}(x) \times (s - \delta, s + \delta)$. This is clearly the required one, as $\text{cone}(x) \cong \text{cone}(H^3)$ (by construction), and $(s - \delta, s + \delta) \cong \mathbb{R}$.

Let now $s \in \{0, 1\}$, i.e. α be one of the suspension points. Again, assume that $s = 0$, as the proof works, *mutatis mutandis*, for $s = 1$. Again, in this setting, $q(X \times \{\frac{1}{2}\} \times \mathbb{I})$ is a copy of ΣX ; let $\text{cone}(x)$ be the cone in that copy of ΣX of the pole x . Then, $\text{cone}(x)$ is an open neighborhood covering the X and s factors in the product; taking $U := \text{cone}(x) \times (\frac{1}{4}, \frac{3}{4})$, the result follows. We again include an illustration:

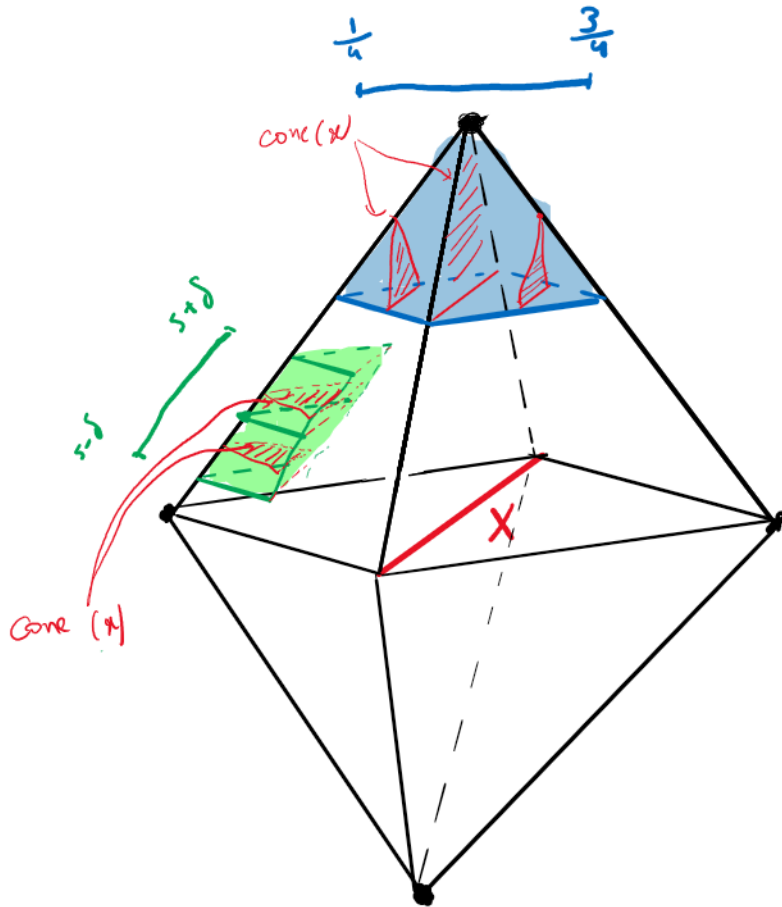

FIGURE 29.7. Local neighborhoods homeomorphic to $\text{cone}(H^3) \times \mathbb{R}$

The green neighbourhood corresponds to the construction of the first case, while the blue one is that of second case. □

29.6. Proof of the Double Suspension Theorem for H^3

We again delay the proof of Theorem 29.11 above, which will be crucial in what follows. We quote the following result by Bryant, established in [Bry68].

THEOREM 29.20. *If M^n is an n -manifold, and $D \subset \text{Int}(M^n)$ is homeomorphic to D^k , for $k \leq n$, then $M^n /_D \times \mathbb{R} \cong M^n \times \mathbb{R}$.*

The proof of the double suspension theorem for H^3 follows easily from Proposition 29.19, Theorems 29.11 and 29.20; indeed, we have a homeomorphism $\varphi: W^4 \setminus B \xrightarrow{\cong} H^3 \times [0, 1]$, since the Giffen disc B is a pseudo-spine of W^4 by Theorem 29.11. Then, it follows that $W^4/B \cong \text{cone}(H^3)$, where the homeomorphism $\Phi: W^4/D \rightarrow \text{cone}(H^3)$ is defined as being the map φ on $W^4 \setminus B$, while mapping $[B]$ (the point onto which B collapses) to the coning point $[H^3 \times \{1\}]$ in $\text{cone}(H^3)$. Another way to see the above homeomorphism is to note that they are both the one point compactification of $H^3 \times [0, 1]$, and that one point compactification of Hausdorff locally compact spaces is unique up to homeomorphism.

By Lemma 29.4, it is sufficient to show that $\Sigma^2 H^3$ is a manifold, since it is clearly compact. As mentioned above, all points in $H^3 \setminus \Gamma$ are clearly manifold points, i.e. have neighborhoods homeomorphic to 5 dimensional Euclidean space. For points $x \in \Gamma$, Proposition 29.19 yields a neighborhood $x \in U \subset H^3$ such that $U \cong \text{cone}(H^3) \times \mathbb{R}$. From the above discussion, we note that $U \cong W^4/B \times \mathbb{R}$. By Bryant's Theorem, i.e. Theorem 29.20 above, we get that $U \cong W^4 \times \mathbb{R}$, which is itself a manifold of dimension 5. Thus, $\Sigma^2 H^3$ is locally 5-Euclidean. It is easy to check that $\Sigma^2 H^3$ is second countable and Hausdorff, and consequently, $\Sigma^2 H^3$ is a 5 dimensional compact topological manifold, and thus by Lemma 29.4, $\Sigma^2 H^3 \cong S^5$.

29.7. Proof of Theorem 29.11

In this section, we give a sketch of the proof of Theorem 29.11. We begin by showing that $T(\sigma)$ collapses to Ω under an infinite sequence of collapses. To see this, consider $[0, 1] \times B_1^2 \times [0, 1]$, where $[0, 1] \times B_1^2$ is as in Figure 29.3. Then, we have the following collapse in the above set:

$$[0, 1] \times B_1^2 \times [0, 1] \searrow (L_1 \times [0, 1]) \cup ([0, 1] \times B_1^2 \times \{1\}) \cup (\{1\} \times B_1^2 \times [0, 1])$$

A very rough illustration is given in Figure 29.8.

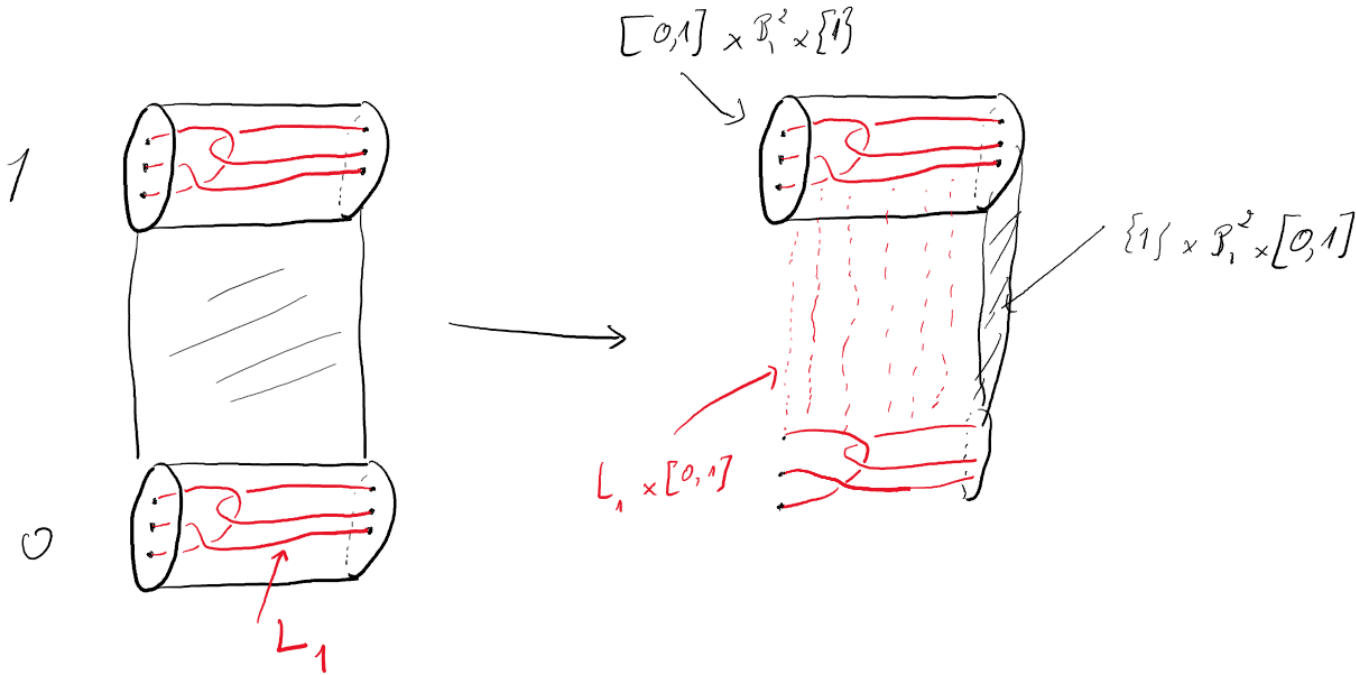

FIGURE 29.8. Sketch of the above collapse.

Then, taking the image of the above collapse in the mapping torus, this would be the first step of the collapse $T(\sigma) \searrow \Omega$. That is, for $n \in \mathbb{N}$, where all the B_i^2 , for $i \leq n$, have been collapsed to their underlying subcylinder, we consider the collapse

$$[n, n+1] \times B_{n+1}^2 \times [0, 1] \searrow (L_{n+1} \times [0, 1]) \cup ([n, n+1] \times B_{n+1}^2 \times \{1\}) \cup (\{n+1\} \times B_{n+1}^2 \times [0, 1]).$$

Since $W^4 = (S^1 \times D^3) \cup_{\varphi} (D^2 \times D^2)$, we get, by the definition of collapses, that

$$W^4 \searrow (S^1 \times D^3) \cup (D^2 \times \{0\}).$$

We thus get the following sequence of collapses:

$$W^4 \searrow (S^1 \times D^3) \cup_{\varphi} D^2 \times \{0\} \cong T(\sigma) \cup (D^2 \times \{0\}) \searrow \Omega \cup (D^2 \times \{0\}) = B.$$

However, the last collapse here differs from our definition, as it is the composition of infinitely many collapses, namely the ones defined inductively in the above. However, this can be resolved via the regular neighborhood theorem. Indeed, we have written B as $B = \bigcap_{i \in \mathbb{N}} K_i$, where K_i are the sets above. Then, W^4 collapses to each K_i , as there are finitely many collapses connecting them. For any small enough regular neighborhood N_i of K_i , which exists by the regular neighborhood theorem, we have $N_i \setminus \text{int}(N_{i+1}) \cong \partial N_i \times [0, 1]$. Then, we have the following equalities

$$W^4 \setminus B = W^4 \setminus \left(\bigcap_{i \in \mathbb{N}} K_i \right) = W^4 \setminus \left(\bigcap_{i \in \mathbb{N}} N_i \right) = \bigcup_{i \in \mathbb{N}} (W^4 \setminus N_i).$$

Since W^4 collapses to N_i , we have that $W^4 \setminus N_i \cong \partial W^4 \times [0, 1]$; but since $N_i \setminus \text{int}(N_{i+1}) \cong \partial N_i \times [0, 1]$, it follows that the above union is exactly $\partial W^4 \times [0, \infty) = H^3 \times [0, \infty)$; thus, B is indeed a pseudo-spine, which concludes the proof of the double suspension theorem in the setting of the Mazur homology 3-sphere.

Part XI
Solutions

Solutions to the exercises

Ekin Ergen, Christian Kremer, Isacco Nonino, and Arunima Ray

Solution to Exercise 1.1. Solution by Ekin Ergen.

The line with two origins: let $X = \mathbb{R} \sqcup \mathbb{R} / \sim$, where $x_i \sim y_j$ iff $x_i = y_j \neq 0$, where $i, j \in \{1, 2\}$ denote the components of the disjoint sum the element is coming from. Let this space with the quotient topology with respect to the standard topologies of \mathbb{R} . In other words, we are gluing the two lines at corresponding points except 0.

- (1) This space is not Hausdorff at 0: there are two points that correspond to 0. These points are not separable by open subsets of X , as any open neighbourhoods of 0_1 and 0_2 of X include some balls $(-\varepsilon_1, \varepsilon_1)$ respectively $(-\varepsilon_2, \varepsilon_2)$. However, these cannot be disjoint by construction.
- (2) Paracompact: by the quotient topology, every open cover of X can be pulled back to an open cover of $\mathbb{R} \sqcup \mathbb{R}$ by taking preimages of $p: \mathbb{R} \sqcup \mathbb{R} \rightarrow \mathbb{R} \sqcup \mathbb{R} / \sim = X$. This has a locally finite open refinement since \mathbb{R} and therefore $\mathbb{R} \sqcup \mathbb{R}$ are paracompact. Again by the quotient topology, the image of this refinement is locally finite.
- (3) Pick $p(-\varepsilon_1, \varepsilon_1)$ for some $\varepsilon_1 \in \mathbb{R}$. This is a Euclidean open neighbourhood in X due to quotient topology.

Solution to Exercise 1.2. Solution by Christian Kremer.

Let Ω be the first uncountable ordinal. This is a well-ordered set which is not countable with the property that for all $i \in \Omega$, the set $\{j \in \Omega \mid j \leq i\}$ is countable. Take a copy of $[0, 1)$ for each $i \in \Omega$ to define a set R . Elements are of the form (x, i) where $i \in \Omega$ and x lies in the copy of $[0, 1)$ corresponding to i . This set has a total order by $[x, i] \leq [y, j]$ if either $i < j$ or $i = j$ and $x \leq y$. Taking intervals to be open defines a topology on R . Also R has a smallest element 0. Since the set $\{j \leq i\}$ is countable, we see that $[0, (i, x)]$ is actually homeomorphic to a compact interval in \mathbb{R} . Define $L = R \coprod_0 R$. This is clearly a locally 1-Euclidean Hausdorff space. It is also (path-)connected, so if it were paracompact, it would be second countable.

But L is not second countable, since L has a collection of uncountably many disjoint sets open sets, namely the sets $U_i = \{x \in R \subset L \mid (0, i) < x < (1, i)\}$. If it were second-countable there would have to exist countably many nonempty sets, each of which lies in some U_i , that cover all the U_i' . This would imply that Ω is countable.

Solution to Exercise 1.3. Solution by Ekin Ergen.

Let M be a compact topological manifold with charts $\{U_i\}_{i \in I}$ for some finite set I . Without loss of generality, M is connected, otherwise we can embed each component of M in some \mathbb{R}^{N_i} . Since M is compact, there are finitely many components, which each have a compact image on \mathbb{R}^{N_i} , so we can take the largest of the N_i and embed the disjoint union via appropriate translations (and extensions with respect to dimension of \mathbb{R}) of each of the embeddings. In particular, the dimension of M is well-defined; let us call it n . Choose embeddings $\iota_i: U_i \rightarrow \mathbb{R}^n$. Choose a partition of unity $\{f_i\}_{i \in I}$ subordinate to $\{U_i\}$, let A_i be the support of f_i . Define

$h_i: U_i \rightarrow \mathbb{R}^n$ with

$$(1.1) \quad h_i(x) := \begin{cases} f_i(x)\iota_i(x), & x \in U_i \\ 0, & x \in X \setminus A_i \end{cases}$$

This is a well-defined continuous map because $\{f_i\}$ is a partition of unity. Finally, for $N = |I|(n + 1)$ define $F: X \rightarrow \mathbb{R}^N$ by $x \mapsto (f_1(x), f_2(x), \dots, f_n(x), h_1(x), \dots, h_n(x))$. This map is continuous as it is continuous in each component. M is compact and \mathbb{R}^N is Hausdorff, so by the compact-Hausdorff argument, it is also open. Finally, it is injective: let $F(x) = F(y)$. Then $f_i(x) = f_i(y)$ and $h_i(x) = h_i(y)$ for all i . Some $f_i(x)$ must be nonzero since for each x , these add up to 1, which implies that $\iota_i(x) = \iota_i(y)$ for some i . But ι_i is an embedding, so $x = y$.

Solution to Exercise 2.1. (PS6.1) Solution by Isacco Nonino. We want to show that every connected topological manifold M with empty boundary is homogeneous.

Step 1: We show that for any two points $a, b \in \text{Int}(D^n)$ there exist a homeomorphism of the disc, fixed on the boundary, sending a to b .

- First we produce a radial shrink t in order to make the radius of a the same as the radius of b (embed D^n in \mathbb{R}^n). Without loss of generality, suppose that the radius of a is at least the radius of b .
- Next, take the ball of radius b and rotate the boundary of the ball by a rotation r in order to send the shrunken a (the image of a under the radial shrink just described) to b . We can extend this to the b -ball with the Alexander Trick. Then we extend on the other side of the boundary by making the rotation “die” in a continuous way:

$$(2.1) \quad r_{t+(1-t)b} \cdot x = e^{\phi(t)\pi i} \cdot x$$

where $\phi(t)$ shrinks the angle continuously, $\phi(0) = \theta_0$ is the original rotation angle, and $\phi(1) = 0$.

- Compose $h = r \cdot t$ to get the desired homeomorphism, $h(a) = b$ and $h|_{\partial D^n} = id$.

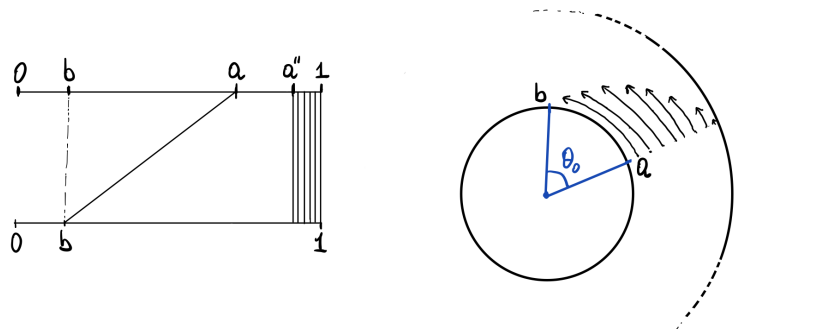

FIGURE 2.1. The two steps

Step 2 We show that the orbit of each point under the action of $\text{Homeo}(M)$ is both open and closed. Since M is connected, this implies that the orbit is indeed M .

- First we show that the orbit is open. Take b in the orbit of x , so there is an $h \in \text{Homeo}(M)$ such that $h(x) = b$. Take a euclidean open ball B around b . We will show that this ball is contained in the orbit of x . Indeed, by composing with the chart homeomorphism ϕ , this ball becomes the interior of a disc in \mathbb{R}^n ; we saw that given $\phi(y), y \in B$ there is an homeomorphism H of this disc, fixed on the boundary, sending $\phi(b)$ to $\phi(y)$. The composition $\phi^{-1}H\phi$ can be extended to the whole manifold M by using the pasting lemma and taking the identity outside B (this is possible because the homeomorphism on the disc fixes the boundary). The extended homeomorphism is an element of $\text{Homeo}(M)$ sending b to y . We compose this with h to send x to y . Hence y lies in the orbit of x , and this works for each y in B . Thus, the orbit set is open.

- Now we show that the orbit is closed. Take a point c lying outside the orbit of x . Again, by considering a euclidean ball C around c and the chart homeomorphism ϕ , we can construct homeomorphisms sending c to each point of C . So, if a point in C lies in the orbit of x , then by composing with the inverse of the previous homeomorphism we would get that c itself lies in the orbit, which is a contradiction. Hence, the complement of the orbit set is open, so the orbit set is closed.

Solution to Exercise 4.1. (PS2.3)

Solution to Exercise 5.1. (PS2.1) Solution by Ekin Ergen.

It suffices to show the latter of the two statements, as $[0, 1] \subset \mathbb{R}^3$ is locally flat by definition. Using the hint, we choose all of the balls B_i to be centered at the compactification point p (granting $\cap B_i \supset \{x\}$), and their radii should be so that the ball B_i contains all but the i leftmost knots in its interior, and its boundary crosses γ in exactly one point.

To find the isotopies, we have to unknot the partial arcs. When we were working with the one-sided Fox-Artin arc, we moved the free end to unknot all the knots one by one. This time, however, we have to keep both ends of partial arcs $\gamma \cap (B_i \setminus \text{Int } B_{i+1})$ (that consist of one knot each by construction) constant throughout the isotopy in order to maintain identity on the complement. Therefore, the idea is to 'move the other end'. This is not allowed either, but we can realize this as sliding the knot through B_{i+1} . Then we will only have moved $\gamma \cap (B_i \setminus \text{Int } B_{i+1})$.

Each of these unknottings yield ambient isotopies $H_t^i: B_i \rightarrow B_i$ $t \in [0, 1]$ that fix ∂B_i as well as B_{i+1} (e.g. by the isotopy extension theorem, after a slight thickening of $\gamma \cap (B_i \setminus B_{i+1})$). Define

$$(5.1) \quad h(x) = \begin{cases} H_1^i(x), & x \in B_i \setminus \text{Int } B_{i+1} \text{ for some } i \\ x, & \text{elsewhere} \end{cases}$$

Clearly, h is continuous in $\mathbb{R}^3 \setminus \{p\}$. In fact, it is also continuous in p : for any $\varepsilon > 0$, we can pick $\delta = \varepsilon$ to fulfill the $\varepsilon - \delta$ -criterion as points do not move away from slices under h . Therefore h is continuous. Passing from \mathbb{R}^3 to S^3 by compactification and using the compact-Hausdorff argument, we can also see that it is open. Bijectivity can be seen restricting to $B_i \setminus \text{Int } B_{i+1}$, as points do not move from one slice to another under any of the given homeomorphisms.

Solution to Exercise 5.2. (PS2.2)

Solution to Exercise 6.1. (Not assigned as homework)

Solution to Exercise 6.2. (Not assigned as homework)

Solution to Exercise 6.3. (Not assigned as homework) Let $\Sigma \subseteq S^n$ be an embedded S^{n-1} and let $S^n - \Sigma = A \cup B$. If A is a smooth ball, then \bar{A} is an embedded disc. By the smooth Palais' Theorem, we are able to isotope this disc to the lower hemisphere, in which case the B will be diffeomorphic to the (open) upper hemisphere. In particular, it will be a smooth ball.

Solution to Exercise 6.4. (Not assigned as homework)

Solution to Exercise 6.5. (PS3.1) Solution by Isacco Nonino. The double Fox-Artin arc is not cellular in the interior of D^3 . Let α be the double Fox-Artin arc. Suppose that α is cellular. Then we have that $D^3/\alpha \cong D^3$. Now $D^3/\alpha \setminus \{pt\} \cong D^3 \setminus \alpha$ by Proposition 6.7 where $\{pt\}$ is the image of α in D^3/α . By assumption, we have the following:

$$D^3 \setminus \{pt\} \cong D^3/\alpha \setminus \{pt\} \cong D^3 - \alpha$$

So we see that if the double Fox-Artin arc were cellular, then the complement of the double Fox-Artin arc in the disc would be homeomorphic to the complement of a point in D^3 . Now this space is homeomorphic to $S^2 \times (0, 1]$, which is homotopy equivalent to a sphere. Since homeomorphism preserves this property, $D^3 \setminus \alpha$ must be homotopy equivalent to a sphere. However, we saw that the complement of the double Fox Artin arc has nontrivial fundamental group, which leads to a contradiction. Therefore, the double Fox-Artin arc is not cellular in D^3 .

Solution to Exercise 6.6. (PS3.2) Solution typed up by Arunima Ray. Check out Bing's book, Geometric Topology of 3-manifolds, Theorem V.2.C as well.

The compact set $M \setminus U_1$ is contained in U_2 and therefore is contained in (the image of) a round collared ball B_1 of large radius in U_2 (the round balls of increasing radius give a compact exhaustion of \mathbb{R}^n). Then the boundary $\Sigma = \partial B_1$ is a bicollared sphere in U_2 . By the Schoenflies theorem, Σ bounds a ball B_2 in U_2 and we have $M = B_1 \cup B_2$ where the two balls are being glued together along the boundary. By the Alexander trick, the result of gluing two balls together along the boundary is homeomorphic to S^n .

For part (b), we know by hypothesis that each suspension point has a Euclidean neighbourhood. By the definition of a suspension, these neighbourhoods can be stretched out so that M is the union of the two neighbourhoods, which are homeomorphic to \mathbb{R}^n by definition. Now apply part (a).

Solution to Exercise 6.7. (PS3.3) Since \bar{U} is a manifold, the boundary is collared by Brown's theorem (Theorem 4.5). Then while Σ might not be bicollared, a push-off of Σ into the collar is. Let Σ' denote such a push-off. Then by the Schoenflies theorem, each component of $S^n \setminus \Sigma'$ is a ball. But then \bar{U} is homeomorphic to a ball union a boundary collar, which is still a ball.

Solution to Exercise 6.8. (PS3.4) Solution by Isacco Nonino.

Let $f: D^n \rightarrow D^n$ be an embedding. We know that $f(D^n)$ is locally collared. By Brown's result, given $B \subseteq X$, with B and X compact, then locally collared implies globally collared (Theorem 4.5). So we have a global collar

$$h: f(S^{n-1}) \times [0, 1] \rightarrow D^n$$

for $f(S^{n-1})$. Now we will prove that $f(D^n)$ is cellular in D^n . We define B_i to be $f(D^n) \cup h(f(S^{n-1}) \times [0, 1/i])$. These B_i are all homeomorphic to D^n since each is a ball with an added boundary collar. Also $\text{Int } B_i \subseteq B_{i-1}$ and the intersection of all B_i is precisely $f(D^n)$ (the sequence of $1/i$ converges to zero, corresponding exactly to $f(S^{n-1})$). Hence $f(D^n)$ is cellular. We obtain:

$$\begin{aligned} D^n / f(D^n) &\cong D^n \\ D^n \setminus f(D^n) &\cong D^n / f(D^n) \setminus \{pt\} \cong D^n \setminus \{pt\} \cong S^{n-1} \times (0, 1] \end{aligned}$$

Solution to Exercise 8.1. (PS4.1) Solution by Isacco Nonino.

First key observation. Let $r: B \rightarrow \{b\}$ be the retraction to the point b . Then the assumption that B is contractible tells us that $r \cong id$.

Second key observation. Recall the following result. Given a paracompact space A , two maps $f, g: A \rightarrow B$ such that $f \cong g$, and a microbundle ξ over B , then $f^*\xi$ is isomorphic to $g^*\xi$. Now we can stare at the following diagram.

$$\begin{array}{ccc} r^*E & \longrightarrow & E \\ \downarrow & & \downarrow j \\ B & \xrightarrow{r} & B \end{array} \qquad \begin{array}{ccc} E & \longrightarrow & E \\ \downarrow & & \downarrow j \\ B & \xrightarrow{id} & B \end{array}$$

Combining our observations, we see that $r^*E \cong E$ for each microbundle E over B . So it suffices to show that r^*E is isomorphic to the trivial microbundle. The total space of r^*E is precisely $B \times j^{-1}(\{b\})$. Now by the local trivialization property, given $U \ni b$ an open neighbourhood of b , there is a $V \subseteq E$ such that $V \cong U \times \mathbb{R}^n$.

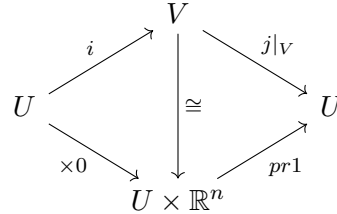

We consider the microbundle $(B \hookrightarrow B \times j|_V^{-1}(\{b\}) \rightarrow B)$, which is isomorphic to r^*E . Remember that we just care about what happens locally around the ‘zero section’ $x \rightarrow (x, i(b))$.

Consider now the microbundle $E|_{\{b\}}$, the restriction of E at the point b . There is an homeomorphism $h: j|_V^{-1}(\{b\}) \rightarrow \{b\} \times \mathbb{R}^n \cong \mathbb{R}^n$ coming from the local trivialization homeomorphism.

Now we conclude by the diagram

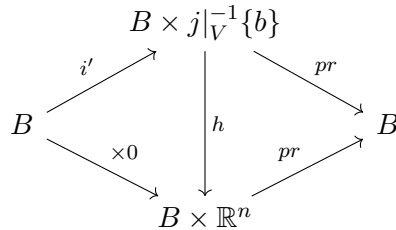

that r^*E , and hence E itself, is isomorphic to the trivial microbundle.

Solution to Exercise 8.2. (PS4.3) Solution by Ekin Ergen.

Recall that the compact-open topology of $C(X, Y)$ is generated by a subbasis $\{f|f(K) \subset U\}_{K,U}$, where K runs over compact subsets of X and U runs over open subsets of Y .

- (1) The compact open topology is coarser than uniform topology. We want to see that all open subsets with respect to the compact open topology is open with respect to the uniform topology. To this end, it suffices to show this claim for the subbasis mentioned above, as all open subsets of compact open topology are generated by finite intersections of such sets. Let $B(K, U) := \{f \mid f(K) \subset U\}$ be a such open set for a fixed K and U as above. Let $f \in B(K, U)$. If we can show $B(f, \varepsilon) \subset B(K, U)$ for some ε , we are done because then we can take the union over all f as $B(K, U)$. Here, it suffices to pick $\varepsilon = d(f(K), U')$ where U' denotes the complement of U . Then any $h \in B(f, \varepsilon)$ satisfies $d(f(x), h(x)) < d(f(K), U') \leq d(f(x), U')$ for all $x \in K \Rightarrow h(x) \in U$. Note that $d(f(K), U')$ is well-defined because both are closed and $f(K)$ is compact.
- (2) The uniform topology is coarser than the compact open topology. Conversely, we want to find $f \in T \subset B(f, \varepsilon)$ for given f, ε , such that T is open with respect to the compact open topology. For each $x \in X$, pick N_x such that $f(N_x)$ lies in the ε' -neighbourhood of $f(x)$ for some $\varepsilon' < \varepsilon/3$, which we call U_x to use later. In particular, $f(\overline{N_x})$ has diameter less than $2\varepsilon/3$. Since X is compact, we can find a finite cover among N_x , say of the points x_1, \dots, x_n . Finally define $C_i := \overline{N_{x_i}}$ and $U_i := U_{x_i}$ that $f(C_i)$ lies in. Then $\bigcap_{i=1}^n B(C_i, U_i)$ includes f and lies in $B(f, \varepsilon)$. To see the latter, let $g \in \bigcap_{i=1}^n B(C_i, U_i)$. As $X = \bigcup C_i$, $x \in X$ means $x \in C_i$ for some i , and hence $g(x) \in U_i$ because $g \in B(C_i, U_i)$. Then $d(f(x), g(x)) \leq d(f(x), f(x_i)) + d(f(x_i), g(x)) \leq \varepsilon'/3 + 2\varepsilon'/3 < \varepsilon$.

Solution to Exercise 8.3. Solution by Isacco Nonino and Christian Kremer.

The result is generally attributed to unpublished work of Brown. It is sketched in [EK71a, p. 85]. Alternative proofs are given in [Sie68, p. 535] and [Sie70a, Corollary 5.4].

Let $h: X \times \mathbb{R} \rightarrow Y \times \mathbb{R}$ be a homeomorphism. The key point in this argument will be that $Y \times \mathbb{R}$ has two product structures, the intrinsic one and the one induced from $X \times \mathbb{R}$ via h .

Let X_t denote $X \times \{t\}$ for $t \in \mathbb{R}$ and let $X_{[t,u]}$ denote $X \times [t,u]$ for $[t,u] \subseteq \mathbb{R}$. Similarly, let Y_s denote $Y \times \{s\}$ for $s \in \mathbb{R}$ and let $Y_{[r,s]}$ denote $Y \times [r,s]$ for $[r,s] \subseteq \mathbb{R}$. By compactness of X and Y , there exist $a < c < e$ and $b < d$ such that

- (1) $Y_a, Y_c, Y_e, h(X_b)$, and $h(X_d)$ are pairwise disjoint in $Y \times \mathbb{R}$,
- (2) $h(X_b) \subseteq Y_{[a,c]}$,
- (3) $Y_c \subseteq h(X_{[b,d]})$, and
- (4) $h(X_d) \subseteq Y_{[c,e]}$,

as illustrated in the leftmost panel in Figure 8.8. This may be achieved by first fixing a , and then choosing as follows.

- Choose b so that (1) is satisfied for a and b .
- Choose $c > a$ so that (1) and (2) are satisfied for a, b , and c .
- Choose $d > b$ so that (1) and (3) are satisfied for a, b, c , and d .
- Choose $e > c$ so that (1) and (4) are satisfied.

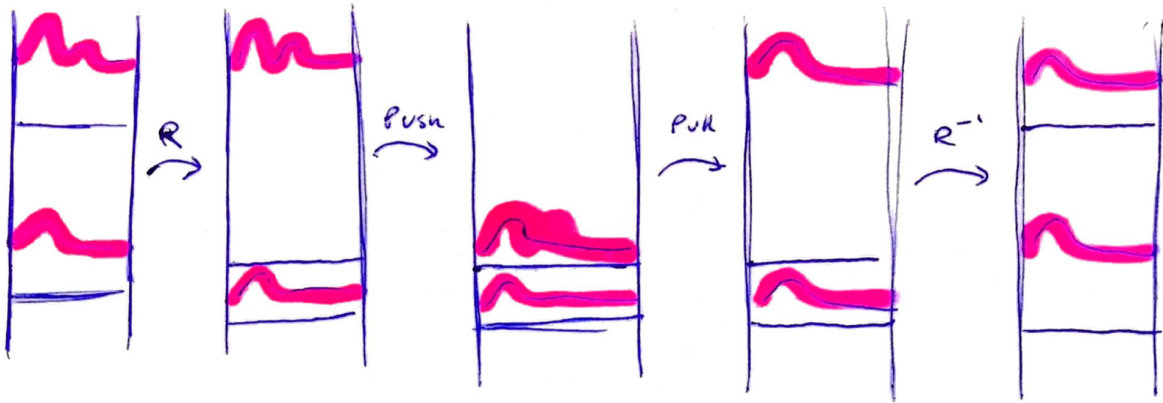

FIGURE 8.8. The push-pull construction. Each panel depicts the space $Y \times \mathbb{R}$. The blue and yellow regions denote $h(X_{[b,d]})$ and $Y_{[a,c]}$, respectively. Note that the regions overlap.

Now we construct a self-homeomorphism χ of $Y \times \mathbb{R}$ as the composition

$$\chi = C^{-1} \circ P_Y \circ P_X \circ C,$$

where the steps are illustrated in Figure 8.8. The maps P_X and P_Y will constitute the actual pushing and pulling while C , which we might call *cold storage*, makes sure that nothing is pushed or pulled unless it is supposed to be.

The maps are obtained as follows:

- The map C rescales the intrinsic \mathbb{R} -coordinate of $Y \times \mathbb{R}$ such that $C(Y_{[a,c]})$ lies below $h(X_b)$ and leaves $h(X_d)$ untouched. We require C to be the identity on $Y_{[c+\varepsilon,\infty)}$ and $Y_{(-\infty,a]}$, for ε small enough so that $Y_{c+\varepsilon} \subsetneq h(X_{[b,d]})$.
- The map P_X pushes $h(X_d)$ down to $h(X_b)$ along the \mathbb{R} -coordinate induced by h , that is, the image of the product structure of $X \times \mathbb{R}$, without moving $C(Y_{[a,c]})$.
- The map P_Y pulls $h(X_b) = (P_X \circ C \circ h)(X_d)$ up along the intrinsic \mathbb{R} -coordinate of $Y \times \mathbb{R}$ so that it lies above the support of C^{-1} , again without moving $C(Y_{[a,c]})$. This can be done in such a way that P_Y is supported below Y_e .

The map χ is the identity outside of $Y_{[a,e]}$. Observe that χ leaves $h(X_b)$ untouched and that $\chi(h(X_d))$ appears as a translate of $h(X_b)$ in the intrinsic \mathbb{R} -coordinate. In other words, for each $x \in X$ we have that $\chi h(x, d) = \tau_K(\chi h(x, b))$, where τ_K is the translation in $Y \times \mathbb{R}$ by some constant K .

Define $H := \chi \circ h: X \times \mathbb{R} \rightarrow Y \times \mathbb{R}$, and consider the diagram

$$\begin{array}{ccc} X \times [b, d] & \xrightarrow{H|} & Y \times \mathbb{R} \\ b \sim d \downarrow \pi & & t \sim t+K \downarrow e \\ X \times S^1 & \xrightarrow{g} & Y \times S^1 \end{array}$$

where the lower horizontal map $g: X \times S^1 \rightarrow Y \times S^1$ is by definition the composition $e \circ H| \circ \pi^{-1}$. The map g is well defined since $H(x, d) = \tau_K H(x, b)$. Similarly g is injective since H is a homeomorphism and $e(y, t) = e(y, t')$ implies, without loss of generality, that either $(y, t) = (y, t')$ or $(y, t) = H(x, b)$ and $(y, t') = H(x, d)$ for some x . It remains only to check that g is surjective. It suffices to show that for each $(y, t) \in Y \times \mathbb{R}$ there exists $n \in \mathbb{Z}$ such that $\tau_K^n(y, t) \in H(X_{[b,d]})$. Fix some (y, t) . Observe that the complement of $H(X_{[b,d]})$ in $Y \times \mathbb{R}$ has two components. Let N be the least integer such that $p := \tau_K^N(y, t)$ lies strictly above $H(X_{[b,d]})$. We now prove that $p' := \tau_K^{N-1}(y, t) \in H(X_{[b,d]})$. The line $\{y\} \times \mathbb{R} \ni p, p'$ intersects $H(X_{[b,d]})$ in a disjoint collection of intervals, that is,

$$(\{y\} \times \mathbb{R}) \cap H(X_{[b,d]}) = \{y\} \times ([t_1, t_2] \cup [t_3, t_4] \cdots \cup [t_L, t_1+K] \cup [t_2+K, t_3+K] \cup \cdots \cup [t_{L-1}+K, t_L+K])$$

for some odd L . In particular, $\{(y, t_i)\}$ are the intersections of $\{y\} \times \mathbb{R}$ with $H(X_b)$ and $\{(y, t_i + K)\}$ are those with $H(X_d)$. (Depending on the shape of $H(X_b)$ the intervals may not have been listed in ascending order, i.e. it might be that, e.g., $t_1 + K < t_i$ for some i). Nonetheless, observe that, under the product metric, we have that $d(p, (y, t_1)) > K$ while $d(p, p') = K$. So p' lies above (y, t_1) on the line $\{y\} \times \mathbb{R}$.

If $p' \in \{y\} \times (t_{2i}, t_{2i+1})$ for some i , then

$$K = d(p, p') > d(p, (y, t_{2i+1})) > d((y, t_{2i+1} + K), (y, t_{2i+1})) = K,$$

which is a contradiction. If p' lies in the component of $(Y \times \mathbb{R}) \setminus H(X_{[b,d]})$ above $H(X_{[b,d]})$, it would contradict the minimality of N . Then either p' lies in one of the intervals of the form $\{y\} \times [t_{2i-1}, t_{2i}]$ or $\{y\} \times [t_{2i} + K, t_{2i+1} + K]$, which implies that p' lies in $H(X_{[b,d]})$ as desired.

Solution to Exercise 9.1. (PS4.2) Solution by Isacco Nonino.

Following Milnor's idea, we start by defining the composition of two microbundles.

Step 1: composition of microbundles. Let $\xi: B \rightarrow E \rightarrow B$ and $\nu: E \rightarrow E' \rightarrow E$ be two microbundles such that the total space of ξ is equal to the base space of ν . We define a new microbundle over B with total space E' as $\xi \cdot \nu$:

$$B \xrightarrow{i \cdot i'} E' \xrightarrow{j \cdot j'} B,$$

where the inclusions and projections are the ones inherited from ξ and ν .

Step 2: the normal and tangent microbundle cases. Let $t_M: M \xrightarrow{\Delta} M \times M \xrightarrow{pr_1} M$ be the tangent microbundle and let p_2^*n be the pullback of the normal microbundle via the projection onto second coordinate

$$\begin{array}{ccccc}
 M \times M & & & & \\
 & \searrow^{i'} & & & \\
 & & p_2^*(U) & \longrightarrow & U \\
 & & \downarrow pr_1 & & \downarrow r \\
 & & M \times M & \xrightarrow{pr_2} & M
 \end{array}$$

where the total space is $p_2^*(U) = \{((m, \bar{m}), u) \mid \bar{m} = r(u)\}$. Now define the composition $t_M \cdot p_2^*n$:

$$M \xrightarrow{i' \cdot \Delta} p_2^*(U) \xrightarrow{pr_1 \cdot pr_1} M$$

(with some abuse of notation for the projections). Consider now $t_N|_M$:

$$M \xrightarrow{\Delta} M \times N \xrightarrow{pr_1} M$$

We want to show that they are isomorphic. $i' \cdot \Delta(M): m \mapsto ((m, m), i(m)) \in p_2^*U$ for $i: M \hookrightarrow U$, while $\Delta(M): m \mapsto (m, m) \in M \times N$. There is an open neighbourhood of $i' \cdot \Delta(M)$ (which we can think of as a ‘cube diagonal’, in some sense) which can be mapped homeomorphically to an open neighbourhood of $\Delta(M)$ in $M \times N$: take an open neighbourhood U_m of each fibre $r^{-1}(m)$ in U and then take the union on each m . This gives an open set $\bigcup_m (m, m) \times U_m$ that can be mapped to $\bigcup_m m \times U_m$, an open neighbourhood in $M \times N$. Hence the two microbundles are isomorphic.

We do a similar procedure with pr_1^*n . In this case the isomorphism is much clearer: the total space of the Whitney Sum is given exactly by $E(t_M \oplus n) = \{((m, m'), u) \mid m' = r(u)\}$, while the total space of $p_1^*n = \{((m, m'), u) \mid m = r(u)\}$. Hence by the following diagram:

$$\begin{array}{ccccc}
 & & E(t_M \oplus n) & & \\
 & \nearrow^{m \rightarrow ((m, m), i(m))} & \downarrow id & \searrow^{pr_1 \cdot pr_1} & \\
 M & & & & M \\
 & \searrow_{m \rightarrow ((m, m), i(m))} & \downarrow id & \nearrow_{pr_1 \cdot pr_1} & \\
 & & E(pr_1^*n) & &
 \end{array}$$

we see that the two microbundles $t_M \oplus n$ and $t_M \cdot pr_1^*n$ are indeed isomorphic.

Now we take D to be a neighbourhood of the diagonal in $M \times M$ such that the two projection maps are homotopic. To do so, recall that M is an ENR. Let V be the euclidean neighborhood that retracts on M . Now take D to be the set of all (m, m') such that the segment joining m, m' lies within V . Now we can construct a homotopy between the projections as $H: M \times M \times I \rightarrow M$ by $H((m, m'), t) := (1 - t)m + tm'$, which is continuous and $H_0 = pr_1, H_1 = pr_2$.

By the property of the induced microbundle, we see that $p_1^*n|D \cong p_2^*n|D$. Moreover:

- the microbundle \bar{t}_M , obtained by taking D as the total space instead of $M \times M$ and restricting the projection to D , is isomorphic to t_M , since restricting the neighbourhood of the zero section does not change the isomorphism type of the microbundle.
- the composed microbundle $\bar{t}_M \cdot p_1^*n|D: M \rightarrow E(p_1^*n|D) \rightarrow M$ is isomorphic to the composed microbundle $t_M \cdot p_1^*n: M \rightarrow E(p_1^*n) \rightarrow M$. Again, we are just taking a restricted neighbourhood of the zero section, the defining maps are just the restriction of the others. The same holds for the projection on second coordinate.

Step 3: conclusion Now we have all the ingredients in our hands to obtain the result.

$$(9.1) \quad t_M \cdot p_1^*n \cong \bar{t}_M \cdot p_1^*n|D \cong \bar{t}_M \cdot p_2^*n|D \cong t_M \cdot p_2^*n$$

By (1) plus the results obtained in the previous two steps, we eventually obtain:

$$(9.2) \quad t_M \oplus n \cong t_N|_M$$

Solution to Exercise 11.1. TBD

Solution to Exercise 15.1. (PS7.2) Solution by Christian Kremer. The "only if" part is clear. Notice that for every $f \in \text{Homeo}(M)$, the map given by postcomposition with f induces an isomorphism $f_*: \text{Homeo}(M) \rightarrow \text{Homeo}(M)$. It is continuous being the restriction of the composition $\text{Homeo}(M) \times \text{Homeo}(M) \rightarrow \text{Homeo}(M)$ to the subspace $\{f\} \times \text{Homeo}(M)$ and clearly has the inverse $(f^{-1})_*$. If $U \subseteq \text{Homeo}(M)$ is a contractible neighbourhood of the identity, then $f_*(U)$ is a contractible neighbourhood of f : It contains f , is open and contractible since f_* is a homeomorphism. As a side remark, it is not in general true that $\text{Homeo}(M)$ is a topological group since the inversion may not be continuous.

Solution to Exercise 15.2. (PS7.1) Solution by Christian Kremer. First, we check that the sets of the form $W(f, K, \varepsilon)$ are actually open. Let $g \in W(f, K, \varepsilon)$ be an element. Let $m = \max\{d(f(x), g(x)) \mid x \in K\}$. Then $g \in W(g, K, \varepsilon - m) \subseteq W(f, K, \varepsilon)$, so it actually suffices to find an open neighbourhood of f in $W(f, K, \varepsilon)$, which will make notation a little easier. Cover $f(K)$ with finitely balls B_i of radius $2/3$ such that the compact sets $K_i = f^{-1}(1/2 \cdot \overline{B_i}) \cap K$ cover K . Then $f \in V(K_i, B_i)$. Suppose $g \in \bigcap_i V(K_i, B_i)$ and $x \in K$ is a point. Pick i with $x \in K_i$ and let x_i be the centre of the ball B_i . Then

$$d(g(x), f(x)) \leq d(x_0, f(x)) + d(g(x), x_0) < \frac{\varepsilon}{3} + \frac{2\varepsilon}{3} = \varepsilon.$$

Hence $f \in \bigcap_i V(K_i, B_i) \subseteq W(f, K, \varepsilon)$.

Now we check that those sets constitute a basis of the topology. It suffices to show that for all $f \in U$ open, there is $f \in W(g, K, \varepsilon) \subseteq U$. First, we can find a finite intersection of sets of the form $V(K_i, W_i)$ which is contained in U containing f , since those sets form a subbasis. Let ε_i be the distance of $f(K_i)$ and the complement of U_i . Then $f \in W(f, K_i, \varepsilon_i) \subseteq V(K_i, W_i)$. Now notice that

$$W(f, \bigcup_i K_i, \min_i \{\varepsilon_i\}) \subseteq \bigcap_i V(K_i, W_i) \subseteq U.$$

This finishes the proof. Notice that if M is compact, $f \in W(f, M, \varepsilon) \subseteq W(f, K, \varepsilon)$ for each K . Since for any f in an open subset U we can find K and ε with $f \in W(f, K, \varepsilon) \subseteq U$, we see that actually sets of the form $W(f, M, \varepsilon)$ already form a basis of the topology. Of course, this is the topology induced by the ∞ -norm.

Solution to Exercise 15.3. (PS6.2) Solution by Christian Kremer.

- (i) The orientation-behaviour of homeomorphisms defines a map $\text{Homeo}(\mathbb{R}^2) \rightarrow \{+, -\}$. To see this, notice that $\text{Homeo}(\mathbb{R}^2)$ is locally path-connected (for example, since it is locally contractible) and isotopic homeomorphisms have the same orientation-behaviour. (A possible definition of the orientation behaviour either could be of homological flavor or by passing to the one-point compactification S^2 . An isotopy of homeomorphisms of \mathbb{R}^2 induces an isotopy of homeomorphisms of S^2 .)
- (ii) We know that $\text{Homeo}(\mathbb{R}^2)$ is homotopy equivalent to $\text{Homeo}_0(\mathbb{R}^2)$. The map $f \mapsto (f(1, 0))/|f((1, 0))| \in S^1$ is continuous and admits a section by $S^1 \subseteq O(1) \subseteq \text{Homeo}_0(\mathbb{R}^2)$. Thus, S^1 is a retract of $\text{Homeo}_0(\mathbb{R}^2)$, so $\text{Homeo}_0(\mathbb{R}^2)$ can not be contractible. (For example, the inclusion $S^1 \rightarrow \text{Homeo}_0(\mathbb{R}^2)$ has to induce an injection on fundamental groups and the fundamental group of S^1 is famously non-trivial.)

Solution to Exercise 15.4. (PS7.3) Solution by Christian Kremer. We indicate the construction of the map in the picture below.

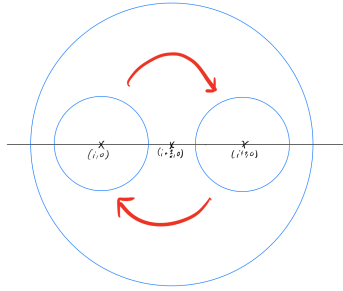

FIGURE 15.3. Schematic picture of the map h_i .

The first homology of M is freely generated by arcs γ_i around B_i . Now $H_1(h_i)(\gamma_i) = \gamma_{i+1}$ so that h_i does not induce the identity on homology. Hence it can not be homotopic to the identity. Using 15.2 we see that a neighbourhood basis of the identity is given by sets of the form $W(\text{Id}, K, \varepsilon) \cap \text{Homeo}(M)$. Since each K is contained in a ball around 0 of radius r and $W(\text{Id}, \overline{B_r(0)}, \varepsilon) \subseteq W(\text{Id}, K, \varepsilon)$, actually sets of the form $W(\text{Id}, B, \varepsilon)$ where B is a closed ball around the origin. For every closed ball around the origin there is an i such that h_j is the identity on this ball for $j \geq i$, so the sequence (h_i) converges to the identity. Since every neighbourhood of the identity contains a map of the form h_i , all of which are not homotopic to the identity, no neighbourhood of the identity is path-connected, since a path in the space of homeomorphisms is a homotopy (even stronger, an isotopy).

Solution to Exercise 17.1. (PS8.1) Solution by Isacco Nonino.

First proof. We first prove the result using the stable homeomorphism theorem SH_n . Let $h: T^n \rightarrow T^n$ be an orientation preserving homeomorphism. We saw in class that such homeomorphism can be lifted to an homeomorphism $\tilde{h}: \mathbb{R}^n \rightarrow \mathbb{R}^n$ such that

$$\begin{array}{ccc} \mathbb{R}^n & \xrightarrow{\tilde{h}} & \mathbb{R}^n \\ e \downarrow & & \downarrow e \\ T^n & \xrightarrow{h} & T^n \end{array}$$

commutes. By SH_n , since \tilde{h} is an orientation preserving homeomorphism, \tilde{h} is stable. Let $\{U_i\}$ be open subsets of \mathbb{R}^n such that $\tilde{h} = \tilde{h}_1 \circ \dots \circ \tilde{h}_k$, where \tilde{h}_i agrees with identity on U_i . Define $V_i := e(U_i)$, which is open in T^n . Let $h_i := e \circ \tilde{h}_i \circ e^{-1}$. Clearly, $h_i|_{V_i} = \text{Id}$ and by definition $h = e \circ \tilde{h} \circ e^{-1} = h_1 \circ \dots \circ h_k$. Therefore h is stable.

Second proof. We show the result without using SH_n .

- We first suppose that $h^*: \pi_1(T^n, x_0) \rightarrow \pi_1(T^n, x_0) = \text{Id}$. (This is independent from the choice of the basepoint x_0 ; we can also assume that h preserves the basepoint x_0 since T^n is homogeneous). Now we lift the homeomorphism to the universal cover \mathbb{R}^n as we did before.

$$\begin{array}{ccc} \mathbb{R}^n & \xrightarrow{\tilde{h}} & \mathbb{R}^n \\ e \downarrow & & \downarrow e \\ T^n & \xrightarrow{h} & T^n \end{array}$$

Without loss of generality, suppose that $x_0 = e(0, \dots, 0) = (1, \dots, 1)$. Take the unit cube I^n and let $M := \max\{\|\tilde{f}(x) - x\| \mid x \in I^n\}$. The maximum M exist since I^n is compact. The identity condition on the fundamental groups implies that each integer point on the lattice $\mathbb{Z}^n \subseteq \mathbb{R}^n$ is fixed by the lift \tilde{h} . This means that each unit cube with integer vertices in \mathbb{R}^n is mapped in exactly in the same way as I^n (since integer

translations are deck transformations). This means $\max\{\|\tilde{f}(x) - x\| \mid x \in \mathbb{R}^n\} = M$, i.e. \tilde{h} is at bounded distance from the identity. Thus \tilde{h} is stable and we conclude as in the previous proof.

- Suppose now that the induced map on fundamental groups is not the identity. Let A be the $n \times n$ matrix that encodes h^* . Important: A has determinant 1 since it is invertible and has \mathbb{Z} entries.

Claim: there exist a diffeomorphism $g: T^n \rightarrow T^n$ such that g^* has matrix expression A^{-1} .

Proof of the claim: The matrix A^{-1} corresponds to a mapping of the integral lattice \mathbb{Z}^n to itself (notice that in the previous point we were using that the mapping was the identity). A^{-1} is the product of elementary matrices with integer entries; each elementary matrix represent a diffeomorphism of \mathbb{R}^n . By passing to the quotient space over the integer lattice -the torus- we obtain a product of diffeomorphism of T^n , i.e. a diffeomorphism g such that when lifted acts on the integral lattice by A^{-1} . Now $g \circ h$ is the identity on the fundamental group and by our previous step this means $g \circ h$ is stable. Since $h = g^{-1} \circ (g \circ h)$, it suffices to show that the diffeomorphism g is stable itself (because product of stable is stable).

Claim: A diffeomorphism $f: T^n \rightarrow T^n$ is stable.

Proof of claim: We saw in class that every o.p. diffeomorphism of \mathbb{R}^n is stable (we used the smooth isotopy extension theorem there). So we can consider a smooth structure for the torus T^n ; given a diffeomorphism $\varphi: T^n \rightarrow T^n$, composing it with the atlas diffeomorphisms gives a diffeomorphism of \mathbb{R}^n . This is stable, and hence the original diffeomorphism is stable as well.

Now that we have this result, we deduce that h is stable as we wanted to show.

Solution to Exercise 17.2. (PS8.2) Solution by Isacco Nonino.

Step 1. Recall that $\text{Homeo}(\mathbb{R}^n)$ has two connected components. Moreover, the connected component containing the identity – call it I – consists of orientation preserving homeomorphisms. If we can prove that the space of stable homeomorphisms is both closed and open in $\text{Homeo}(\mathbb{R}^n)$, then it must be one of the two connected components of $\text{Homeo}(\mathbb{R}^n)$. But as we saw in class, stable homeomorphisms are isotopic to the identity, hence $\text{SHomeo}(\mathbb{R}^n)$ must be equal to I .

Step 2. We prove that $\text{SHomeo}(\mathbb{R}^n)$ is open.

- Claim: the identity has an open neighbourhood consisting of stable homeomorphisms. To prove the claim, let C be a compact subset of \mathbb{R}^n . By a previous exercise, $W(C, \varepsilon) = \{f \in \text{Homeo}(\mathbb{R}^n) \mid |h(x) - x| < \varepsilon, x \in C\}$ is an open neighbourhood of the identity for the compact-open topology. Let $h \in W(C, \varepsilon)$. Now we apply the torus trick. Namely, we construct a lift:

$$\begin{array}{ccc}
 T^n & \xrightarrow{\tilde{h}} & T^n \\
 \uparrow & & \uparrow \\
 T^n \setminus 2D^n & \xrightarrow{\hat{h}} & T^n \setminus D^n \\
 \alpha \downarrow & & \downarrow \alpha \\
 \mathbb{R}^n & \xrightarrow{h} & \mathbb{R}^n
 \end{array}$$

where $\alpha(T^n \setminus D^n) \subseteq C$. In particular, the map \hat{h} is an homeomorphism $T^n \rightarrow T^n$. By Exercise 8.1, this homeomorphism is stable. But then going in the other direction we also get that \tilde{h} is stable (it is just the restriction) and hence h is stable as well. Therefore $W(C, \varepsilon)$ consists of stable homeomorphisms.

- Now take another homeomorphism g in $\text{Homeo}(\mathbb{R}^n)$. Since the translation is a continuous map in this topological group, we can just translate the stable-open neighbourhood

$W(C, \varepsilon)$ of id to an open neighbourhood of g consisting of stable homeomorphisms (just pre-compose with g).

Step 3. We prove that $\text{SHomeo}(\mathbb{R}^n)$ is also closed. We know that each coset of $\text{SHomeo}(\mathbb{R}^n)$ in $\text{Homeo}(\mathbb{R}^n)$ is open: this is a general fact about topological groups. Their union is again open, and also equals the complement of $\text{SHomeo}(\mathbb{R}^n)$. Hence $\text{SHomeo}(\mathbb{R}^n)$ is closed. This concludes the proof.

Solution to Exercise 17.3. (PS9.1) Solution by Isacco Nonino.

- (1) Let φ and ψ be the two locally collared embeddings. Let $p := \varphi(0)$ and let $q := \psi(0)$. We proved in a previous problem that M connected n -manifold without boundary is homogeneous. Since both embeddings are locally collared, they land in $\text{Int } M$, so there is a homeomorphism $h_1: M \rightarrow M$ that satisfies $h_1(p) = q$. Note that this new embedded disc is still locally collared. Moreover, by Brown, locally collared implies globally collared.
- (2) Now we produce a homeomorphism h_2 . Namely, we start by taking $\bar{\varphi}: 2D^n \rightarrow M$ corresponding to the union of $h_1\varphi(D^n)$ and its collar. Use $\bar{\varphi}^{-1}: \bar{\varphi}(2D^n) \rightarrow 2D^n \subseteq \mathbb{R}^n$, and consider the image $V := \bar{\varphi}^{-1}(\psi(D^n) \cap \bar{\varphi}(D^n))$, which contains 0. Produce a homeomorphism of \mathbb{R}^n that shrinks the radius of $\bar{\varphi}^{-1}(\varphi(D^n)) = D^n \subseteq 2D^n$ while stretching out the collar $2D^n \setminus D^n$, until this D^n lies within V . Now map forward by $\bar{\varphi}$ back into M . By concatenation, we obtained the desired homeomorphism h_2 of M that sends $h_1 \circ \varphi(D^n)$ inside $\psi(D^n)$, while keeping the boundary of the collared disc fixed.
- (3) Consider $\psi(D^n) \setminus (h_2 \cdot h_1(\text{Int } D^n))$. By the Annulus Conjecture, this is homeomorphic to $\mathbb{S}^{n-1} \times I$ via a . Now stretch $\mathbb{S}^{n-1} \times 0$ over $\mathbb{S}^{n-1} \times 1$ with s and precompose with a^{-1} . This composition, which we will call h_3 , of homeomorphisms stretches the internal disc over the entire $\psi(D^n)$. Note that since ψ is globally collared as well, everything we do inside this disc can be extended to an homeomorphism of M . Now define $h \in \text{Homeo}(M)$ by $h := h_3 \cdot h_2 \cdot h_1$. By construction, $h \cdot \varphi(D^n) = \psi(D^n)$.
- (4) So now we have a homeomorphism h that arranges the two images to be the same. We want a final homeomorphism H of M such that ψ and $H \circ h \circ \phi$ are equal as maps. To do this, we use that every orientation preserving homeomorphism of D^n is isotopic to the identity, for $n \geq 6$. This uses that orientation preserving homeomorphisms of S^{n-1} are isotopic to the identity, and the Alexander trick.

Solution to Exercise 18.1. (PS9.2)

Solution to Exercise 19.1. (PS10.1) Solution by Christian Kremer. Quick outline: Arrange $\phi(0) = \psi(0)$ (1). Using a collar, shrink ϕ until it has image inside the interior of $\psi(D^n)$ (2). Using the Annulus Theorem 17.1 we can blow up ϕ until $\phi(D^n) = \psi(D^n)$ (3). Using the Alexander Isotopy, and the fact that all orientation-preserving homeomorphisms of S^n are isotopic we finally arrange that ϕ and ψ are isotopic (4).

Detailed solution. First notice that Isotopy is an equivalence relation, in particular it is transitive. We will change ϕ up to isotopy until it coincides with ψ . Also note that the notion "being locally collared" is invariant under embeddings which are related by an isotopy from the identity to another homeomorphism $M \rightarrow M$.

- (1) We want to arrange $\phi(0) = \psi(0)$. This follows from the following fact: If M is a connected manifold and p, q are points in its interior, there exists an isotopy from the identity to a self-homeomorphism of M which sends p to q . We do this by showing that the set U of points q for which exists such an isotopy is both open and closed in the interior of M which is connected.

To show that it is open, let q be a point in U . Pick a chart around q such that q is contained in the interior of the unit disc. If q' is any other point in the interior of the unit disc, we can find an obvious isotopy moving q to q' as indicated in the following picture.

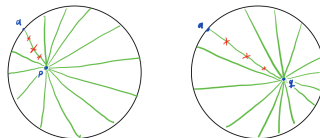

FIGURE 19.5. Moving points inside a disc

To show that it is closed, let q be a point which does not lie in U . Then by the argument above, the same is true for points q' in a small disc neighbourhood of q , since if there exists an isotopy moving p to q' then there would also exist one moving p to q' since as we saw above, there exists one moving q' to q .

- (2) The subspace $M \setminus \text{Int } \phi(D^n)$ is a manifold with boundary since ϕ is assumed to be locally collared. Its boundary includes course ∂D^n . Attaching a collar to this, we see that we can extend ϕ to an embedding $\phi': 2D^n \rightarrow M$. By a push-pull argument, as indicated in the picture below, we can isotope ϕ' relative boundary to arrange $\phi(D^n) \subseteq \psi(D^n)$. We can even arrange that $\phi(D^n)$ maps to the interior of $\psi(D^n)$.

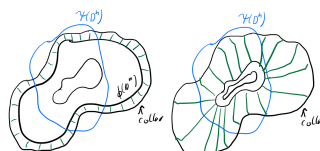

FIGURE 19.6. Another push-pull argument

- (3) By the Annulus Theorem 17.1, $\psi(D^n) \setminus \phi(D^n)$ is an annulus, i.e. there is an embedding $\alpha: \partial(D^n) \times I \rightarrow M$ which maps homeomorphically into $\psi(D^n) \setminus \phi(D^n)$ such that $\alpha|_{\partial D^n \times \{0\}}$ is $\psi|_{\partial D^n}$ under the identification $\partial D^n = \partial D^n \times \{0\}$. We can extend this to an embedding $\beta: \partial D^n \times [-1, 1] \rightarrow M$ using a collar. Denote by f the homeomorphism $\beta|_{\partial D^n \times \{1\}} \circ \psi_{\partial D^n}^{-1}$. Now we define an isotopy

$$H_t: M \rightarrow M, \quad x \mapsto \begin{cases} x & \text{for } x \text{ not in the image of } \phi \text{ or } \beta; \\ \beta(v, s(1 - \frac{t}{2}) - \frac{t}{2}) & \text{for } x = \beta(v, s); \\ \beta(v, 2s(1 - t)) & \text{for } x = \psi(w), s = |w| + \frac{t}{2} \geq 1 \text{ and } v = f(\frac{w}{|w|}); \\ \psi(v \cdot (1 + \frac{t}{2})) & \text{for } x = \psi(v) \text{ and } |v| + \frac{t}{2} \leq 1. \end{cases}$$

Notice that H_0 is the identity and H_1 arranges the $\phi(D^n) = H_1 \circ \phi(D^n)$. Of course, we sketch what H_t is supposed to do in the following picture.

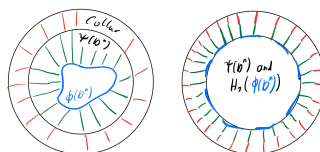

FIGURE 19.7. Lining up ψ and ϕ

- (4) Now we are ready to do the last step. Note that $\psi_{\partial D^n}^{-1} \circ \phi_{\partial D^n}$ defines an orientation-preserving homeomorphism from the sphere to itself. We have already shown that such a homeomorphism is isotopic to the identity, say via an isotopy h_t . Using the Alexander trick, we can extend this to an isotopy of D^n to itself. Define $H_t = \psi \circ h_t$. By the

isotopy extension theorem, this extends to an isotopy of the identity $M \rightarrow M$ to a self-homeomorphism carrying $\psi|_{\partial D^n}$ to $\phi|_{\partial D^n}$. At last, using the Alexander isotopy, we can isotope ψ relative ∂D^n to ϕ .

Solution to Exercise 19.2. (PS10.2)

Solution to Exercise 19.3. (PS11.1) Solution by Isacco Nonino.

If the two locally flat embeddings f, g are locally-flat isotopic (via h_t), then using the IET we can recover an ambient isotopy $H_t : \mathbb{S}^{n+2} \rightarrow \mathbb{S}^{n+2}$ such that $H_0 = id$ and $H_t \cdot h_0 = h_t$. We show that $H_1 : \mathbb{S}^{n+2} \rightarrow \mathbb{S}^{n+2}$ is the desired homeomorphism. First of all, notice that it is indeed orientation preserving: since it is the "ending point" of an isotopy connecting it to the identity, it must lie in the orientation preserving connected component of $Homeo(\mathbb{S}^{n+2})$! Moreover, $H_1 \cdot f = H_1 \cdot h_0 = h_1 = g$, hence $H_1(f(\mathbb{S}^n)) = g(\mathbb{S}^n)$, i.e $H_1(K) = J$. Finally, we have that $(H_1 \cdot f)^{-1} \cdot g : \mathbb{S}^n \rightarrow \mathbb{S}^n$ is isotopic to the identity (via the restriction of H on K), hence it is an orientation preserving homeomorphism of \mathbb{S}^n . Since f, g are indeed orientation preserving, we must have $H_1|_K$ it is as well.

On the other hand, suppose we have an homeomorphism F with the said properties. We have that F is isotopic to the identity, so there exist $H_t : \mathbb{S}^{n+2} \rightarrow \mathbb{S}^{n+2}$ such that $H_0 = id, H_1 = F$. If we precompose the isotopy with f , we obtain $H_t \cdot f : \mathbb{S}^n \rightarrow \mathbb{S}^n$ which is an isotopy between f and $F \cdot f$.

Now, consider $(F \cdot f)^{-1} \cdot g : \mathbb{S}^n \rightarrow \mathbb{S}^n$. This is a well-defined orientation preserving homeomorphism (because we know that $F \cdot f(\mathbb{S}^n) = g(\mathbb{S}^n)$ and the restriction is orientation preserving, hence composition is again orientation preserving). Thus it is isotopic to the identity via an isotopy $h_t : \mathbb{S}^n \rightarrow \mathbb{S}^n$.

Postcompose h_t with $H_1 \cdot f$ to get an isotopy $H_1 \cdot f h_t$ between $F \cdot f$ and g . We can patch together the two isotopies to get an isotopy between f, g . For the local flatness, the only problem should arise when we attach the two isotopies, say at time $1/2$. But we can make sure that in small intervals $[1/2 - \varepsilon], [1/2 + \varepsilon]$ the isotopy is constant! For times in $[1 - \varepsilon, 1 + \varepsilon]$ the isotopy is then constant, and hence locally flat.

Solution to Exercise 19.4. (PS11.2)

Bibliography

- [AH35] P. Alexandroff and H. Hopf. *Topologie*. Springer-Verlag, 1935.
- [Ale24] James W Alexander. On the subdivision of 3-space by a polyhedron. *Proceedings of the National Academy of Sciences of the United States of America*, 10(1):6, 1924.
- [Arm70] M. A. Armstrong. Collars and concordances of topological manifolds. *Comment. Math. Helv.*, 45:119–128, 1970.
- [Bar63] D. Barden. The structure of manifolds, 1963. Ph.D. thesis, Cambridge University.
- [BG63] Morton Brown and Herman Gluck. Stable structures on manifolds. *Bull. Amer. Math. Soc.*, 69:51–58, 1963.
- [BG64a] Morton Brown and Herman Gluck. Stable structures on manifolds. I. Homeomorphisms of S^n . *Ann. of Math. (2)*, 79:1–17, 1964.
- [BG64b] Morton Brown and Herman Gluck. Stable structures on manifolds. II. Stable manifolds. *Ann. of Math. (2)*, 79:18–44, 1964.
- [BG64c] Morton Brown and Herman Gluck. Stable structures on manifolds. III. Applications. *Ann. of Math. (2)*, 79:45–58, 1964.
- [BHS64] H. Bass, A. Heller, and R. G. Swan. The Whitehead group of a polynomial extension. *Inst. Hautes Études Sci. Publ. Math.*, 1(22):61–79, 1964.
- [Bin61] R. H. Bing. A wild surface each of whose arcs is tame. *Duke Math. J.*, 28:1–15, 1961.
- [Bin83] R. H. Bing. *The geometric topology of 3-manifolds*, volume 40 of *American Mathematical Society Colloquium Publications*. American Mathematical Society, Providence, RI, 1983.
- [BKK⁺21] Stefan Behrens, Boldizsár Kalmár, Min Hoon Kim, Mark Powell, and Arunima Ray, editors. *The disc embedding theorem*. Oxford University Press, 2021.
- [BLL65] W. Browder, J. Levine, and G. R. Livesay. Finding a boundary for an open manifold. *Amer. J. Math.*, 87:1017–1028, 1965.
- [Bre97] Glen E. Bredon. *Topology and geometry*, volume 139 of *Graduate Texts in Mathematics*. Springer-Verlag, New York, 1997. Corrected third printing of the 1993 original.
- [Bro60] Morton Brown. A proof of the generalized Schoenflies theorem. *Bull. Amer. Math. Soc.*, 66:74–76, 1960. <https://doi.org/10.1090/S0002-9904-1960-10400-4>.
- [Bro61] Morton Brown. The monotone union of open n -cells is an open n -cell. *Proc. Amer. Math. Soc.*, 12:812–814, 1961.
- [Bro62a] Morton Brown. Locally flat imbeddings of topological manifolds. *Ann. of Math. (2)*, 75:331–341, 1962. <https://doi.org/10.2307/1970177>.
- [Bro62b] Morton Brown. Locally flat imbeddings of topological manifolds. *Ann. of Math. (2)*, 75:331–341, 1962.
- [Bro65] William Browder. Structures on $M \times R$. *Proc. Cambridge Philos. Soc.*, 61:337–345, 1965.
- [Bro69] W. Browder. *Surgery on Simply Connected Manifolds*. Department of Mathematics, Princeton University, 1969.
- [Bro72] William Browder. *Surgery on simply-connected manifolds*. Springer-Verlag, New York-Heidelberg, 1972. *Ergebnisse der Mathematik und ihrer Grenzgebiete, Band 65*.
- [Bry68] J. L. Bryant. Euclidean space modulo a cell. *Fundamenta Mathematicae*, 63:43–51, 1968.
- [Bud] Ryan Budney. Immersing punctured torus. Mathematics Stack Exchange. URL:<https://math.stackexchange.com/q/337288> (version: 2013-03-21).
- [Buo] Sandro Buoncrisiano. Fragments of geometric topology from the sixties. <https://maths.dur.ac.uk/users/mark.a.powell/sandro.pdf>.
- [BV68] J. M. Boardman and R. M. Vogt. Homotopy-everything H -spaces. *Bull. Amer. Math. Soc.*, 74:1117–1122, 1968.
- [Cai61] Stewart S. Cairns. A simple triangulation method for smooth manifolds. *Bull. Amer. Math. Soc.*, 67:389–390, 1961.
- [Can79a] J. W. Cannon. Shrinking cell-like decompositions of manifolds. Codimension three. *Ann. of Math. (2)*, 110(1):83–112, 1979.

- [Can79b] J. W. Cannon. Shrinking cell-like decompositions of manifolds. codimension three. *Annals of Mathematics*, 110(1):83–112, 1979.
- [Cas71] A.J. Casson. Recent advances in topological manifolds, 1971. <https://www.maths.ed.ac.uk/~v1ranick/surgery/cassontop.pdf>.
- [Cha74] T. A. Chapman. Topological invariance of Whitehead torsion. *Amer. J. Math.*, 96:488–497, 1974.
- [Cha79] T. A. Chapman. Locally homotopically unknotted embeddings of manifolds in codimension two are locally flat. *Topology*, 18(4):339–348, 1979. [https://doi.org/10.1016/0040-9383\(79\)90024-7](https://doi.org/10.1016/0040-9383(79)90024-7).
- [CK70] J. Cheeger and J. M. Kister. Counting topological manifolds. *Topology*, 9:149–151, 1970.
- [CM19] Diarmuid Crowley and Tibor Macko. On the cardinality of the manifold set. *Geom. Dedicata*, 200:265–285, 2019.
- [Coh] Ralph L. Cohen. The topology of fibre bundles.
- [Coh73] Marshall M. Cohen. *A course in simple-homotopy theory*. Springer-Verlag, New York-Berlin, 1973. Graduate Texts in Mathematics, Vol. 10.
- [Con63] E. H. Connell. Approximating stable homeomorphisms by piecewise linear ones. *Ann. of Math. (2)*, 78:326–338, 1963.
- [Con71] Robert Connelly. A new proof of Brown’s collaring theorem. *Proc. Amer. Math. Soc.*, 27:180–182, 1971. <https://doi.org/10.2307/2037284>.
- [Dav07] Robert J. Daverman. *Decompositions of manifolds*. AMS Chelsea Publishing, Providence, RI, 2007. Reprint of the 1986 original.
- [Ded62] Paul Dedecker. Variétés linéaires par morceaux et variétés combinatoires. *Ann. Mat. Pura Appl. (4)*, 60:365–383, 1962. <https://doi.org/10.1007/BF02412779>.
- [DK01] James F. Davis and Paul Kirk. *Lecture notes in algebraic topology*, volume 35 of *Graduate Studies in Mathematics*. American Mathematical Society, Providence, RI, 2001.
- [DMF92] Stefano De Michelis and Michael H. Freedman. Uncountably many exotic \mathbf{R}^4 ’s in standard 4-space. *J. Differential Geom.*, 35(1):219–254, 1992.
- [Don87] S. K. Donaldson. Irrationality and the h -cobordism conjecture. *J. Differential Geom.*, 26(1):141–168, 1987.
- [Don90] S. K. Donaldson. Polynomial invariants for smooth four-manifolds. *Topology*, 29(3):257–315, 1990.
- [DV09a] Robert J. Daverman and Gerard A. Venema. *Embeddings in manifolds*, volume 106 of *Graduate Studies in Mathematics*. American Mathematical Society, Providence, RI, 2009.
- [DV09b] Robert J. Daverman and Gerard A. Venema. *Embeddings in manifolds*, volume 106 of *Graduate Studies in Mathematics*. American Mathematical Society, Providence, RI, 2009. <https://doi.org/10.1090/gsm/106>; (nonprinting) pdf available at <http://sites.calvin.edu/venema/embeddingsbook/>.
- [Edw63] C. H. Edwards, Jr. Open 3-manifolds which are simply connected at infinity. *Proc. Amer. Math. Soc.*, 14:391–395, 1963.
- [EK71a] Robert D. Edwards and Robion C. Kirby. Deformations of spaces of imbeddings. *Annals of Mathematics*, 93(1):63–88, 1971.
- [EK71b] Robert D. Edwards and Robion C. Kirby. Deformations of spaces of imbeddings. *Ann. of Math. (2)*, 93:63–88, 1971.
- [ER19] Johannes Ebert and Oscar Randal-Williams. Semisimplicial spaces. *Algebr. Geom. Topol.*, 19(4):2099–2150, 2019.
- [FA48] Ralph H. Fox and Emil Artin. Some wild cells and spheres in three-dimensional space. *Ann. of Math. (2)*, 49:979–990, 1948. <https://doi.org/10.2307/1969408>.
- [Far67] F. Farrell. The obstruction to fibering a manifold over a circle. *Bulletin of the American Mathematical Society*, 73:737–740, 1967.
- [Fer] Steve Ferry. Geometric topology notes.
- [Fer74a] Steven Ferry. An immersion of $T^n - D^n$ into R^n . *Enseign. Math. (2)*, 20:177–178, 1974.
- [Fer74b] Steven Ferry. An immersion of $T^n - D^n$ into R^n . *Enseign. Math. (2)*, 20:177–178, 1974.
- [FQ90] Michael H. Freedman and Frank Quinn. *Topology of 4-manifolds*, volume 39 of *Princeton Mathematical Series*. Princeton University Press, Princeton, NJ, 1990.
- [FR84] D. B. Fuks and V. A. Rokhlin. *Beginner’s course in topology*. Universitext. Springer-Verlag, Berlin, 1984. Geometric chapters, Translated from the Russian by A. Iacob, Springer Series in Soviet Mathematics.
- [Fre82a] Michael Hartley Freedman. The topology of four-dimensional manifolds. *Journal of Differential Geometry*, 17(3):357 – 453, 1982.
- [Fre82b] Michael Hartley Freedman. The topology of four-dimensional manifolds. *J. Differential Geometry*, 17(3):357–453, 1982.
- [Fri73] Bjorn Friberg. A topological proof of a theorem of Kneser. *Proc. Amer. Math. Soc.*, 39:421–426, 1973.
- [Gau71] David B. Gauld. The canonical Schoenflies theorem. *Proc. Amer. Math. Soc.*, 27:603–612, 1971.
- [GM93] Robert E. Gompf and Tomasz S. Mrowka. Irreducible 4-manifolds need not be complex. *Ann. of Math. (2)*, 138(1):61–111, 1993.

- [Gra74] André Gramain. Construction explicite de certaines immersions de codimension 0 ou 1. *Enseign. Math.* (2), 20:333–337, 1974.
- [GS99] Robert E. Gompf and András I. Stipsicz. *4-manifolds and Kirby calculus*, volume 20 of *Graduate Studies in Mathematics*. American Mathematical Society, Providence, RI, 1999.
- [Ham76a] A. J. S. Hamilton. The triangulation of 3-manifolds. *Quart. J. Math. Oxford Ser. (2)*, 27(105):63–70, 1976.
- [Ham76b] A. J. S. Hamilton. The triangulation of 3-manifolds. *Quart. J. Math. Oxford Ser. (2)*, 27(105):63–70, 1976.
- [Han51a] Olof Hanner. Some theorems on absolute neighborhood retracts. *Ark. Mat.*, 1:389–408, 1951.
- [Han51b] Olof Hanner. Some theorems on absolute neighborhood retracts. *Ark. Mat.*, 1:389–408, 1951.
- [Hat01] Allen Hatcher. *Algebraic Topology*. Cambridge University Press, Cambridge, United Kingdom, 2001.
- [Hat02a] Allen Hatcher. *Algebraic topology*. Cambridge University Press, Cambridge, 2002.
- [Hat02b] Allen Hatcher. *Algebraic topology*. Cambridge University Press, Cambridge, 2002.
- [Hat12] Allen Hatcher. A 50-year view of diffeomorphism groups., 2012.
- [Hat13a] Allen Hatcher. The kirby torus trick for surfaces, 2013.
- [Hat13b] Allen Hatcher. The Kirby torus trick for surfaces, 2013.
- [Hir59] M. W. Hirsch. Immersions of manifolds. *Trans. Am. Math. Soc.*, 93:242–276, 1959.
- [Hir61] Morris W. Hirsch. On imbedding differentiable manifolds in Euclidean space. *Ann. Math. (2)*, 73:566–571, 1961.
- [Hir94] Morris W. Hirsch. *Differential topology*, volume 33 of *Graduate Texts in Mathematics*. Springer-Verlag, New York, 1994. Corrected reprint of the 1976 original.
- [HP64] André Haefliger and Valentin Poenaru. La classification des immersions combinatoires. *Inst. Hautes Études Sci. Publ. Math.*, 1(23):75–91, 1964.
- [HS69] W.-c. Hsiang and J. L. Shaneson. Fake tori, the annulus conjecture, and the conjectures of Kirby. *Proc. Nat. Acad. Sci. U.S.A.*, 62:687–691, 1969.
- [HT00] Ian Hambleton and Laurence R. Taylor. A guide to the calculation of the surgery obstruction groups for finite groups. In *Surveys on surgery theory, Vol. 1*, volume 145 of *Ann. of Math. Stud.*, pages 225–274. Princeton Univ. Press, Princeton, NJ, 2000.
- [Hud69] J. F. P. Hudson. *Piecewise linear topology*. University of Chicago Lecture Notes prepared with the assistance of J. L. Shaneson and J. Lees. W. A. Benjamin, Inc., New York-Amsterdam, 1969.
- [Irw62] M. Irwin. Combinatorial embeddings of manifolds. *Bulletin of the American Mathematical Society*, 68:25–27, 1962.
- [Ker69] Michel A. Kervaire. Smooth homology spheres and their fundamental groups. *Trans. Amer. Math. Soc.*, 144:67–72, 1969.
- [Kir69] R. C. Kirby. Stable homeomorphisms and the annulus conjecture. *Ann. Math. (2)*, 89:575–582, 1969.
- [Kis64] J. M. Kister. Microbundles are fibre bundles. *Ann. of Math. (2)*, 80:190–199, 1964. <https://doi.org/10.2307/1970498>.
- [KK] Robion C. Kirby and James Kister. *Unpublished notes*.
- [KL66] N. H. Kuiper and R. K. Lashof. Microbundles and bundles. I. Elementary theory. *Invent. Math.*, 1:1–17, 1966.
- [KL08] Bruce Kleiner and John Lott. Notes on Perelman’s papers. *Geom. Topol.*, 12(5):2587–2855, 2008.
- [KM63a] Michel A. Kervaire and John W. Milnor. Groups of homotopy spheres. I. *Ann. of Math. (2)*, 77:504–537, 1963.
- [KM63b] Michel A. Kervaire and John W. Milnor. Groups of homotopy spheres: I. *Annals of Mathematics*, 77(3):504–537, 1963.
- [Kne26] Hellmuth Kneser. Die Deformationssätze der einfach zusammenhängenden Flächen. *Math. Z.*, 25(1):362–372, 1926.
- [KS77a] Robion C. Kirby and Laurence C. Siebenmann. *Essay VI, Foundational essays on topological manifolds, smoothings, and triangulations*. Princeton University Press, 1977.
- [KS77b] Robion C. Kirby and Laurence C. Siebenmann. *Foundational essays on topological manifolds, smoothings, and triangulations*. Princeton University Press, Princeton, N.J.; University of Tokyo Press, Tokyo, 1977. With notes by John Milnor and Michael Atiyah, *Annals of Mathematics Studies*, No. 88.
- [KS79] R.C. Kirby and M.G. Scharlemann. Eight faces of the Poincaré homology 3-sphere. In JAMES C. CANTRELL, editor, *Geometric Topology*, pages 113–146. Academic Press, 1979.
- [L02] Wolfgang Lück. A basic introduction to surgery theory. In *Topology of high-dimensional manifolds, No. 1, 2 (Trieste, 2001)*, volume 9 of *ICTP Lect. Notes*, pages 1–224. Abdus Salam Int. Cent. Theoret. Phys., Trieste, 2002.
- [Lee69] J. Alexander Lees. Immersions and surgeries of topological manifolds. *Bull. Amer. Math. Soc.*, 75:529–534, 1969.

- [Lee13a] John M. Lee. *Introduction to smooth manifolds*, volume 218 of *Graduate Texts in Mathematics*. Springer, New York, second edition, 2013.
- [Lee13b] John M. Lee. *Introduction to smooth manifolds*, volume 218 of *Graduate Texts in Mathematics*. Springer, New York, second edition, 2013.
- [Maz59] Barry Mazur. On embeddings of spheres. *Bull. Amer. Math. Soc.*, 65:59–65, 1959.
- [Maz63] Barry Mazur. Relative neighborhoods and the theorems of Smale. *Ann. of Math. (2)*, 77:232–249, 1963.
- [Mil56] John Milnor. On manifolds homeomorphic to the 7-sphere. *Ann. of Math. (2)*, 64:399–405, 1956.
- [Mil63] J. Milnor. *Morse theory*. Annals of Mathematics Studies, No. 51. Princeton University Press, Princeton, N.J., 1963. Based on lecture notes by M. Spivak and R. Wells.
- [Mil64] J. Milnor. Microbundles. I. *Topology*, 3(suppl, suppl. 1):53–80, 1964. [https://doi.org/10.1016/0040-9383\(64\)90005-9](https://doi.org/10.1016/0040-9383(64)90005-9).
- [Mil65] John Milnor. *Lectures on the h-cobordism theorem*. Notes by L. Siebenmann and J. Sondow. Princeton University Press, Princeton, N.J., 1965.
- [Mil97a] John W. Milnor. *Topology from the differentiable viewpoint*. Princeton Landmarks in Mathematics. Princeton University Press, Princeton, NJ, 1997. Based on notes by David W. Weaver, Revised reprint of the 1965 original.
- [Mil97b] John W. Milnor. *Topology from the differentiable viewpoint*. Princeton Landmarks in Mathematics. Princeton University Press, Princeton, NJ, 1997. Based on notes by David W. Weaver, Revised reprint of the 1965 original.
- [Mil03] John Milnor. Towards the Poincaré conjecture and the classification of 3-manifolds. *Notices Amer. Math. Soc.*, 50(10):1226–1233, 2003.
- [Mil11] John Milnor. Differential topology forty-six years later. *Notices Amer. Math. Soc.*, 58(6):804–809, 2011.
- [Moi52a] Edwin E. Moise. Affine structures in 3-manifolds: V. the triangulation theorem and hauptvermutung. *Annals of Mathematics*, 56(1):96–114, 1952.
- [Moi52b] Edwin E. Moise. Affine structures in 3-manifolds. V. The triangulation theorem and Hauptvermutung. *Ann. of Math. (2)*, 56:96–114, 1952.
- [Moi77] Edwin E. Moise. *Geometric topology in dimensions 2 and 3*. Graduate Texts in Mathematics, Vol. 47. Springer-Verlag, New York-Heidelberg, 1977.
- [Mor60] Marston Morse. A reduction of the Schoenflies extension problem. *Bull. Amer. Math. Soc.*, 66:113–115, 1960.
- [MS74] John W. Milnor and James D. Stasheff. *Characteristic classes*. Princeton University Press, Princeton, N. J.; University of Tokyo Press, Tokyo, 1974. Annals of Mathematics Studies, No. 76.
- [MT07] John Morgan and Gang Tian. *Ricci flow and the Poincaré conjecture*, volume 3 of *Clay Mathematics Monographs*. American Mathematical Society, Providence, RI; Clay Mathematics Institute, Cambridge, MA, 2007.
- [Mun00a] James R. Munkres. *Topology*. Prentice Hall, Inc., Upper Saddle River, NJ, 2000. Second edition of [MR0464128].
- [Mun00b] James R. Munkres. *Topology*. Prentice Hall, Inc., Upper Saddle River, NJ, 2000. Second edition of [MR0464128].
- [New66] M. H. A. Newman. The engulfing theorem for topological manifolds. *Ann. of Math. (2)*, 84:555–571, 1966.
- [Nov64] S. P. Novikov. Homotopically equivalent smooth manifolds. I. *Izv. Akad. Nauk SSSR Ser. Mat.*, 28:365–474, 1964.
- [Pal60] Richard S. Palais. Extending diffeomorphisms. *Proc. Amer. Math. Soc.*, 11:274–277, 1960.
- [Pap57] C. D. Papakyriakopoulos. On dehn’s lemma and the asphericity of knots. *Annals of Mathematics*, 66(1):1–26, 1957.
- [Per02] G. Perelman. The entropy formula for the Ricci flow and its geometric applications. arXiv:0211159, 2002.
- [Per03a] G. Perelman. Finite extinction time for the solutions to the Ricci flow on certain three-manifolds. arXiv:0307245, 2003.
- [Per03b] G. Perelman. Ricci flow with surgery on three-manifolds. arXiv:0303109, 2003.
- [Per03c] Grisha Perelman. Ricci flow with surgery on three-manifolds, 2003.
- [Qui82a] Frank Quinn. Ends of maps. III. Dimensions 4 and 5. *J. Differential Geometry*, 17(3):503–521, 1982. <http://projecteuclid.org/euclid.jdg/1214437139>.
- [Qui82b] Frank Quinn. Ends of maps. III. Dimensions 4 and 5. *J. Differential Geometry*, 17(3):503–521, 1982.
- [Rad24] Tibor Radó. Über eine nicht fortsetzbare Riemannsche Mannigfaltigkeit. *Math. Z.*, 20(1):1–6, 1924.
- [Ran73] Andrew A. Ranicki. Algebraic L -theory. I. Foundations. *Proc. London Math. Soc. (3)*, 27:101–125, 1973.
- [Ran80] Andrew Ranicki. The algebraic theory of surgery. I. Foundations. *Proc. London Math. Soc. (3)*, 40(1):87–192, 1980.

- [Ran81] Andrew Ranicki. *Exact sequences in the algebraic theory of surgery*, volume 26 of *Mathematical Notes*. Princeton University Press, Princeton, N.J.; University of Tokyo Press, Tokyo, 1981.
- [Ran92] Andrew Ranicki. *Lower K- and L-theory*, volume 178 of *London Mathematical Society Lecture Note Series*. Cambridge University Press, Cambridge, 1992.
- [Ran02] Andrew Ranicki. *Algebraic and geometric surgery*. Oxford Mathematical Monographs. The Clarendon Press, Oxford University Press, Oxford, 2002. Oxford Science Publications.
- [Roc52] V. A. Rochlin. New results in the theory of four-dimensional manifolds. *Doklady Akad. Nauk SSSR (N.S.)*, 84:221–224, 1952.
- [RS72] Colin Patrick Rourke and Brian Joseph Sanderson. *Introduction to piecewise-linear topology*. Springer-Verlag Berlin, New York, 1972.
- [RS82] Colin Patrick Rourke and Brian Joseph Sanderson. *Introduction to piecewise-linear topology*. Springer Study Edition. Springer-Verlag, Berlin-New York, 1982. Reprint.
- [Rud91] Walter Rudin. *Functional analysis*. International Series in Pure and Applied Mathematics. McGraw-Hill, Inc., New York, second edition, 1991.
- [Rus73a] T. Benny Rushing. *Topological embeddings*. Academic Press, New York-London, 1973. Pure and Applied Mathematics, Vol. 52.
- [Rus73b] T. Benny Rushing. *Topological embeddings*. Academic Press, New York-London, 1973. Pure and Applied Mathematics, Vol. 52.
- [Sco67] Anne Scott. Infinite regular neighborhoods. *J. London Math. Soc.*, 42:245–253, 1967.
- [Sco05] Alexandru Scorpan. *The wild world of 4-manifolds*. American Mathematical Society, Providence, RI, 2005.
- [Sie65] Laurence Carl Siebenmann. *The obstruction to finding a boundary for an open manifold of dimension greater than five*. ProQuest LLC, Ann Arbor, MI, 1965. Thesis (Ph.D.)—Princeton University.
- [Sie68] L. C. Siebenmann. Pseudo-annuli and invertible cobordisms. *Arch. Math. (Basel)*, 19:528–535, 1968.
- [Sie70a] L. C. Siebenmann. A total Whitehead torsion obstruction to fibering over the circle. *Comment. Math. Helv.*, 45:1–48, 1970.
- [Sie70b] Laurence Siebenmann. Disruption of low-dimensional handlebody theory by Rochlin’s Theorem. *Topology of Manifolds*, 01 1970.
- [Sie77] L. C. Siebenmann. Annex C. Topological Manifolds. *Foundational Essays on Topological Manifolds, Smoothings, and Triangulations. (AM-88)*, page 307–337, 1977.
- [Sma59] Stephen Smale. The classification of immersions of spheres in Euclidean spaces. *Ann. Math. (2)*, 69:327–344, 1959.
- [Sma60] Stephen Smale. The generalized Poincaré conjecture in higher dimensions. *Bull. Amer. Math. Soc.*, 66:373–375, 1960.
- [Sma61] Stephen Smale. Generalized Poincaré’s conjecture in dimensions greater than four. *Ann. of Math. (2)*, 74:391–406, 1961.
- [Sma62a] S. Smale. On the structure of manifolds. *Amer. J. Math.*, 84:387–399, 1962.
- [Sma62b] S. Smale. On the structure of manifolds. *American Journal of Mathematics*, 84(3):387–399, 1962.
- [Spi67] Michael Spivak. Spaces satisfying Poincaré duality. *Topology*, 6:77–101, 1967.
- [SS99] Paul Schmutz Schaller. Systoles and topological Morse functions for Riemann surfaces. *J. Differential Geom.*, 52(3):407–452, 1999.
- [Sta60] John R. Stallings. Polyhedral homotopy-spheres. *Bull. Amer. Math. Soc.*, 66:485–488, 1960.
- [Sta62a] John Stallings. The piecewise-linear structure of Euclidean space. *Proc. Cambridge Philos. Soc.*, 58:481–488, 1962.
- [Sta62b] John Stallings. The piecewise-linear structure of euclidean space. *Mathematical Proceedings of the Cambridge Philosophical Society*, 58(3):481–488, 1962.
- [Sta67] John R. Stallings. *Lectures on polyhedral topology*. Notes by G. Ananda Swarup. Tata Institute of Fundamental Research Lectures on Mathematics, No. 43. Tata Institute of Fundamental Research, Bombay, 1967.
- [Ste75] Ronald J. Stern. On topological and piecewise linear vector fields. *Topology*, 14(3):257–269, 1975. [https://doi.org/10.1016/0040-9383\(75\)90007-5](https://doi.org/10.1016/0040-9383(75)90007-5).
- [SW58] Arnold Shapiro and J. H. C. Whitehead. A proof and extension of Dehn’s lemma. *Bulletin of the American Mathematical Society*, 64(4):174 – 178, 1958.
- [Tau87] Clifford Henry Taubes. Gauge theory on asymptotically periodic 4-manifolds. *J. Differential Geom.*, 25(3):363–430, 1987.
- [Tho74] René Thom. Stabilité structurelle et morphogénèse. *Poetics*, 3(2):7–19, 1974.
- [Thu82] William P. Thurston. Three-dimensional manifolds, Kleinian groups and hyperbolic geometry. *Bull. Amer. Math. Soc. (N.S.)*, 6(3):357–381, 1982.

- [Č73] A. V. Černavskiĭ. The identity of local flatness and local simple connectedness for imbeddings of $(n - 1)$ -dimensional into n -dimensional manifolds when $n > 4$. *Mat. Sb. (N.S.)*, 91(133):279–286, 288, 1973.
- [Wal61] Andrew H. Wallace. Modifications and cobounding manifolds ii. *Journal of Mathematics and Mechanics*, 10(5):773–809, 1961.
- [Wal62] C. T. C. Wall. Killing the middle homotopy groups of odd dimensional manifolds. *Trans. Amer. Math. Soc.*, 103:421–433, 1962.
- [Wal64] C. T. C. Wall. On simply-connected 4-manifolds. *J. London Math. Soc.*, 39:141–149, 1964.
- [Wal65] C. T. C. Wall. Open 3-manifolds which are 1-connected at infinity. *Quart. J. Math. Oxford Ser. (2)*, 16:263–268, 1965.
- [Wal67] C. T. C. Wall. On bundles over a sphere with fibre Euclidean space. *Fund. Math.*, 61:57–72, 1967.
- [Wal69] C. T. C. Wall. On homotopy tori and the annulus theorem. *Bull. London Math. Soc.*, 1:95–97, 1969.
- [Wal99] C. Terence C. Wall. *Surgery on compact manifolds*, volume 69 of *Mathematical Surveys and Monographs*. American Mathematical Society, Providence, RI, second edition edition, 1999. Edited and with a foreword by A. A. Ranicki.
- [Whi61] J. H. C. Whitehead. Manifolds with transverse fields in euclidean space. *Annals of Mathematics*, 73(1):154–212, 1961.
- [Zee62] E. C. Zeeman. The Poincaré conjecture for $n \geq 5$. In *Topology of 3-manifolds and related topics (Proc. The Univ. of Georgia Institute, 1961)*, pages 198–204. Prentice-Hall, Englewood Cliffs, N.J., 1962.
- [Zee63] Eric Christopher Zeeman. *Seminar on Combinatorial Topology*. Number v. 2, No. 8 in Seminar on Combinatorial Topology. Institut des hautes etudes scientifique, 1963.

Index

- Alexander
 - gored ball, 36
 - horned sphere, 34
- concordance, 229
- handle
 - attaching region, 114
 - core, 114
- homeomorphism
 - bounded distance from the identity, 133
 - bounded homeomorphism, 133
- homotopy
 - track, 201
- immersion, 62
- L-groups, 192
- link, 113
- locally Euclidean, xiii, 3
- locally flat isotopy, 201
- manifold, xiii, 3
- Mazur swindle, 54
- microbundle
 - normal, 79
 - stably isomorphic, 78
 - tangent, 66
 - trivial, 66
 - underlying, 66
- nonsingular quadratic form, 278
 - lagrangian, 279
- normal bordism, 191
- normal maps, 277
- piecewise-linear (PL) manifold, xiv
- proper embedding, 201
- proper isotopy, 201
- smooth manifold, xiii
- Spivak normal fibration, 277
- stable normal bundle, 277
- star, 113
- surgery, 191
 - trace of a surgery, 191
- triangulated manifold, xiv
- Wall realisation, 283
- Whitehead
 - continuum, 48
 - manifold, 48
- Whitehead group, 190
- Whitney sum, 78